

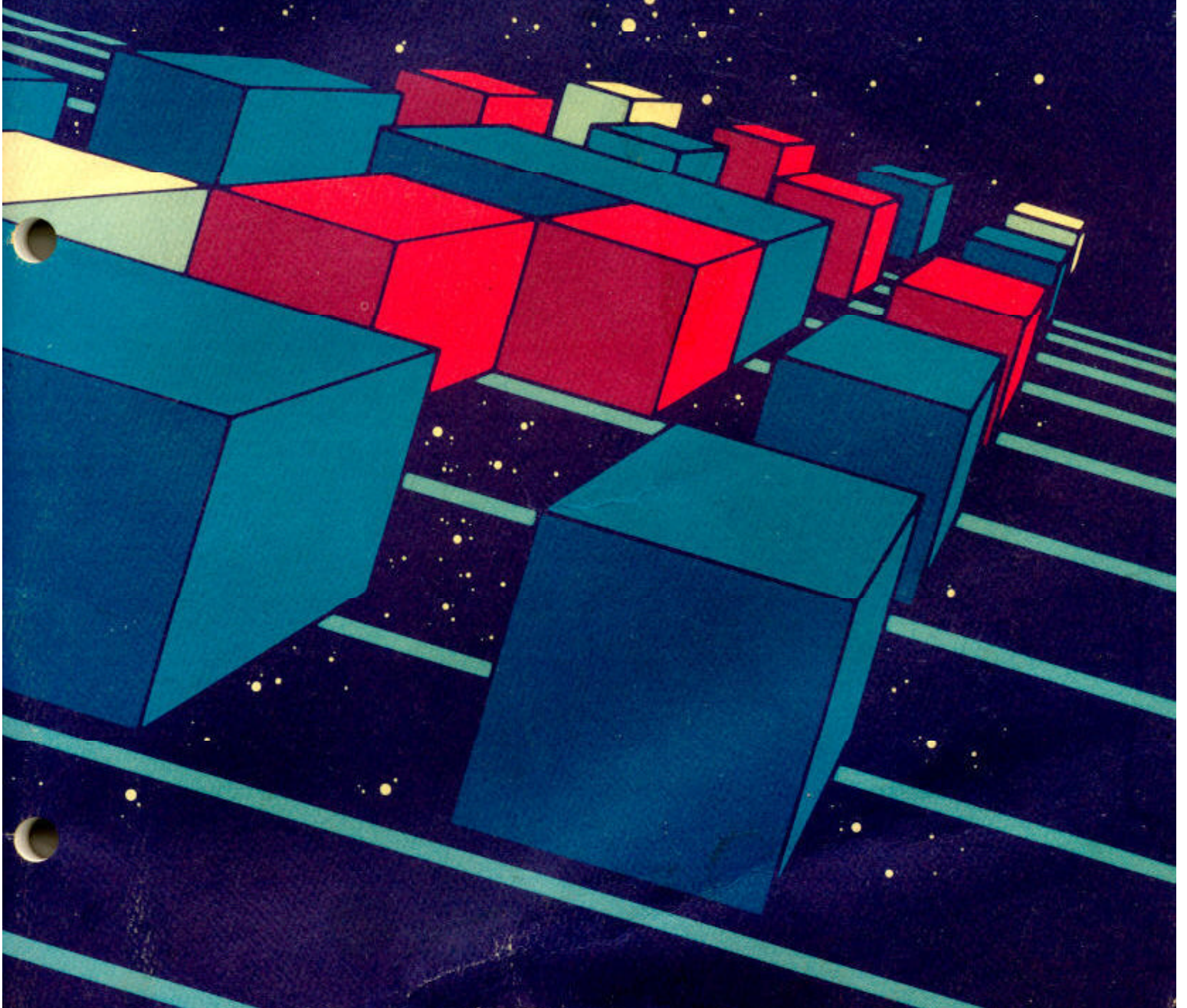

TM-251
1st printing

I, ROBOT

Operators Manual With Illustrated Parts Lists



Atari Customer Service

If reading through this manual does not lead to solving a certain maintenance problem, call TELEHELP® at one of these Atari Customer Service offices:

UNITED STATES

Parts and Service

Atari, Inc.
California Customer Service Office
737 Sycamore
P.O. Box 906
Milpitas, CA 95035
Telex 17-1103
(Monday-Friday, 7:30-4:00 pm Pacific Time)

 Anywhere in the U.S. including Alaska and Hawaii
(408) 943-1120

EUROPE

Parts and Service

Atari Ireland Limited
European Customer Service Office
Tipperary Town, Ireland
Telex 28165
(Monday-Friday, 9:00-6:00 pm GMT)

 **062-52155**

PROBOT

Operators Manual

With Illustrated Parts Lists

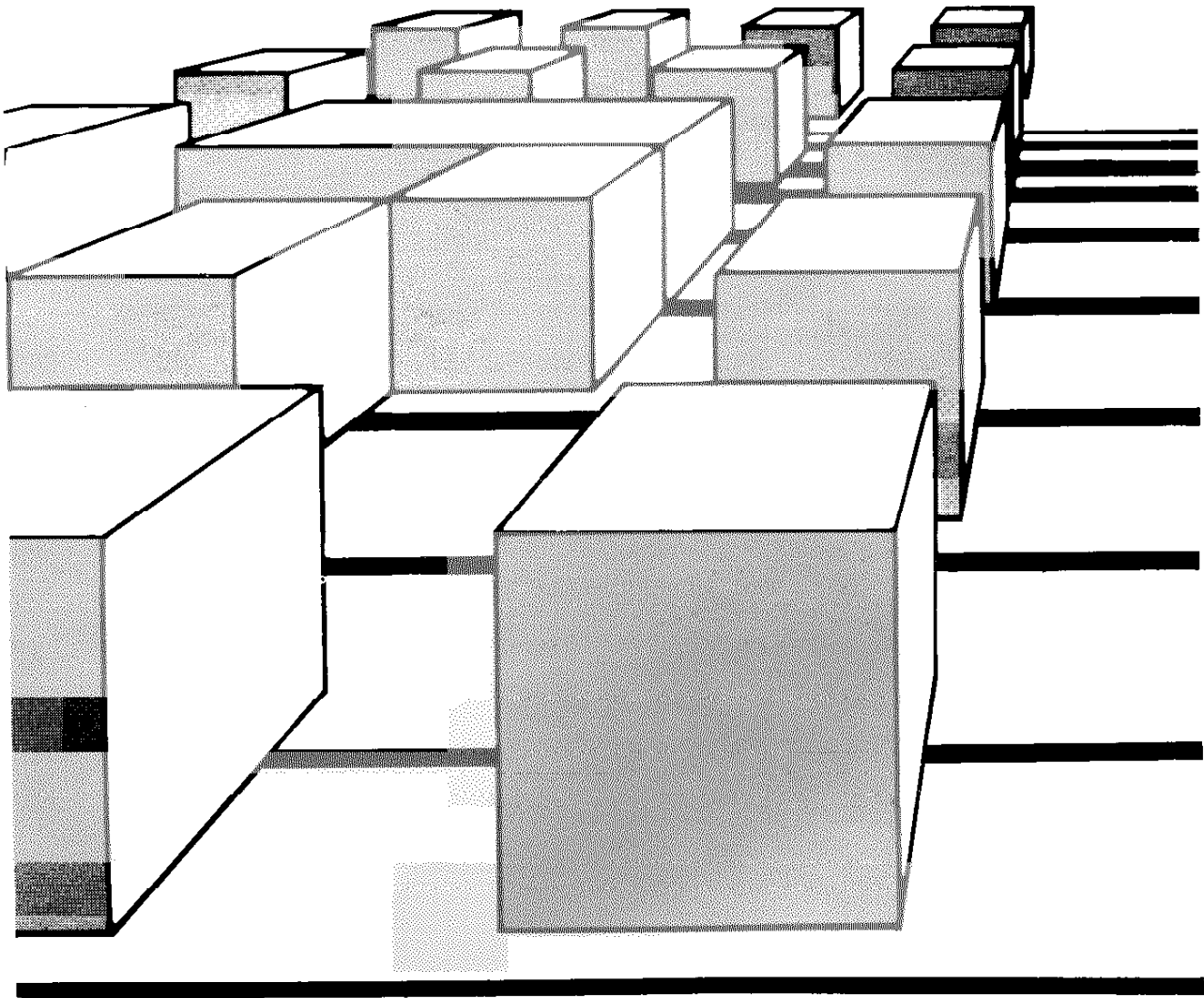

© 1984 by Atari, Inc.

All rights reserved.

No part of this publication may be reproduced by any mechanical, photographic, or electronic process, or in the form of a phonographic recording, nor may it be stored in a retrieval system, transmitted, or otherwise copied for public or private use, without permission from the publisher.

The game play, all graphic designs, this technical manual, its accompanying schematic diagrams, and the display manual are protected by the U.S. Copyright Act of 1976.

This Act provides for increased penalties for violating federal copyright laws. Courts *can* *im-*
pound infringing articles while legal action is pending. If infringers are convicted, courts can *order destruction* of the infringing articles.

In addition, the Act provides for payment of statutory damages of up to \$250,000 in certain cases. Infringers may also have to pay costs and attorneys' fees and face an imprisonment of up to five years.

Atari will aggressively enforce its copyrights against any infringers. *We will use all legal means* to immediately halt any manufacture, distribution, or operation of a copy of video games made by us. Anyone who purchases such copies risks forfeiting such a game.

Published by: Atari, Inc.
790 Sycamore Drive
P.O. Box 906
Milpitas, California 95035

Printed in the U.S.A.

5N

Notice Regarding Non-ATARI Parts

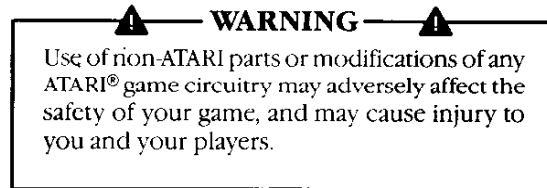

You may void the game warranty (printed on the inside back cover of this manual) if you do any of the following:

- Substitute non-ATARI parts in the game.
- Modify or alter any circuits in the game by using kits or parts *not* supplied by Atari.

NOTE

This equipment generates, uses, and can radiate radio frequency energy and if not installed and used in accordance with the instruction manual, may cause interference to radio communications. It has been tested and found to comply with the limits for a Class A computing device pursuant to Subpart J of Part 15 of Federal Communications Commission (FCC) Rules, which are designed to provide reasonable protection against such interference when operated in a commercial environment. Operation of this equipment in a residential area or modification to this equipment is likely to cause interference in which case the user, at his own expense, will be required to take whatever measures may be required to correct the interference. If you suspect interference from an ATARI® game at your location, check the following:

- All green ground wires in the game are properly connected as shown in the game wiring diagram.
- The power cord is properly plugged into a grounded three-wire outlet.
- The game printed-circuit boards (PCB) are properly installed within the Electromagnetic Interference (EMI) cage.
- The EMI Shield PCB is properly installed and connected in series with the game PCB harness.
- All filter capacitors required on the EMI Shield PCB are properly soldered in place.

If you are still unable to solve the interference problem, please contact ATARI Customer Service. See the inside front cover of this manual for service in your area.

Table of Contents

1	Set-Up	
	How to Use This Manual	1-1
	Game Overview	1-3
	Inspecting the Game	1-3
	Joystick Centering	1-3
	Switch Locations	1-4
	Selecting the Options	1-4
	Game Play	1-5
2	Self-Test	
	Self-Test Displays	2-2
3	Maintenance	
	Preventive Maintenance	3-2
	Removing the Control Panel	3-2
	Lubricating the Joystick Control	3-2
	Cleaning the FIRE Switches	3-2
	Tightening the Start Switches	3-2
	Corrective Maintenance	3-3
	Removing the Joystick Control	3-3
	Disassembling the Joystick Control	3-3
	Reassembling the Joystick Control	3-3
	Removing the Start Switches	3-4
	Removing the FIRE Switches	3-4
4	Illustrated Parts Lists	
Figure 4-1	Cabinet-Mounted Assemblies	4-2
Figure 4-2	Control Panel Assembly	4-6
Figure 4-3	Hall-Effect Joystick Assembly	4-8
Figure 4-4	Utility Panel Assembly	4-10
Figure 4-5	Fluorescent Tube and Speaker Assembly	4-11
Figure 4-6	Coin Controls, Inc. Coin Door Assembly	4-12
Figure 4-7	Coin Acceptors, Inc. Coin Door Assembly	4-15
Figure 4-8	Printed-Circuit Board Mounting Hardware	4-18
Figure 4-9	Central Processing Unit PCB Assembly	4-20
Figure 4-10	Video PCB Assembly	4-28
Figure 4-11	EMI Shield PCB Assembly	4-34

List of Illustrations

Figure 1-1	I, ROBOT Game Overview	1-2
Figure 1-2	Switch Locations.	1-4
Figure 2-1	Accounting and Options Display	2-2
Figure 2-2	Hardware Test—Passes Display	2-3
Figure 2-3	Hardware Test—Fails Display	2-3
Figure 2-4	Joystick Test 1 Display.	2-4
Figure 2-5	Joystick Test 2 Display	2-4
Figure 2-6	Sound Test Display	2-4
Figure 2-7	Alphanumerics Display	2-5
Figure 2-8	Dot, Vector, and Polygon Test Display	2-5
Figure 2-9	Color Bars Display	2-5
Figure 2-10	Grid Pattern Display	2-6
Figure 2-11	Size and Centering Display	2-6
Figure 3-1	Lubricating, Disassembling, and Reassembling the Hall-Effect Joystick	3-5

List of Tables

Table 1-1	Installation Specifications	1-3
Table 1-2	Switch Settings for Bonus Interval and Play Options	1-4
Table 1-3	Switch Settings for Coin & Credit Options and Bonus Adder	1-5
Table 2-1	RAM Locations	2-4
Table 3-1	Recommended Preventive Maintenance Intervals	3-2

Safety Summary

The following safety precautions apply to all game operators and service personnel. Specific warnings and cautions will be found throughout this manual where they apply.

▲ WARNING ▲

Properly Ground the Game. Players may receive an electrical shock if this game is not properly grounded! To avoid electrical shock, do not plug in the game until it has been inspected and properly grounded. This game should only be plugged into a grounded 3-wire outlet. If you have only a 2-wire outlet, we recommend you hire a licensed electrician to install a grounded outlet. Players may receive an electrical shock if the control panel is not properly grounded! After servicing any parts on the control panel, check that the grounding clip is firmly secured to the metal tab on the inside of the control panel. Only then should you lock up the game.

AC Power Connection. Before connecting the game to the AC power source, verify that the proper voltage-selection plug is installed on the game's power supply.

Disconnect Power During Repairs. To avoid electrical shock, disconnect the game from the AC power source before removing or repairing any part of the game. When removing or repairing the video display, extra precautions must be taken to avoid electrical shock because high voltages may exist within the display circuitry and cathode-ray tube (CRT) even after power has been disconnected. Do not touch internal parts of the display with your hands or with metal objects! Always discharge the high voltage from the CRT before servicing this area of the game. To discharge the CRT: Attach one end of a large, well-insulated, 18-gauge jumper wire to ground. Momentarily touch the free end of the grounded jumper to the CRT anode by sliding it under the anode cap. Wait two minutes and discharge the anode again.

Use Only ATARI Parts. To maintain the safety integrity of your ATARI game, do not use non-ATARI parts when repairing the game. Use of non-ATARI parts or other modifications to the game circuitry may adversely affect the safety of your game, and injure you or your players.

Handle Fluorescent Tube and CRT With Care. If you drop a fluorescent tube or CRT and it breaks, it may implode! Shattered glass can fly six feet or more from the implosion.

Use the Proper Fuses. To avoid electrical shock, use replacement fuses which are specified in the parts list for this game. Replacement fuses must match those replaced in fuse type, voltage rating, and current rating. In addition, the fuse cover must be in place during game operation.

CAUTION

Properly Attach All Connectors. Make sure that the connectors on each printed-circuit board (PCB) are properly plugged in. Note that they are keyed to fit only one way. If they do not slip on easily, do not force them. A reversed connector may damage your game and void the warranty.

Ensure the Proper AC Line Frequency. Video games manufactured for operation on 60 Hz line power (i.e., United States) must not be operated in countries with 50 Hz line power (i.e., Europe). The fluorescent light ballast transformer will overheat, causing a potential fire hazard if 60 Hz games are operated off power lines using 50 Hz. Check the product identification label of your game for the line frequency required.

Set Up

⚠ WARNING ⚠

Shock Hazard

To avoid electrical shock, do not plug in the game until it has been inspected and properly set up for the line voltage in your area.

This game should only be connected to a 3-wire outlet. If you have only a 2-wire outlet, we recommend you hire a licensed electrician to install a grounded outlet. Players may receive an electrical shock if this game is not properly grounded!

Do not touch internal parts of the display with your hands or metal objects!

How to Use This Manual

This manual, written for game operators and service technicians, describes your new ATARI game.

Chapter 1 contains a game overview, game specifications, inspection procedures, switch locations, option information, and a description of game play.

Chapter 2 contains self-test procedures.

Chapter 3 contains maintenance and repair procedures.

Chapter 4 contains illustrated parts lists. Notes in this chapter refer you to other places in the manual for more detailed information.

Schematic diagrams of the game circuitry are included as a supplement (SP-251) to this manual.

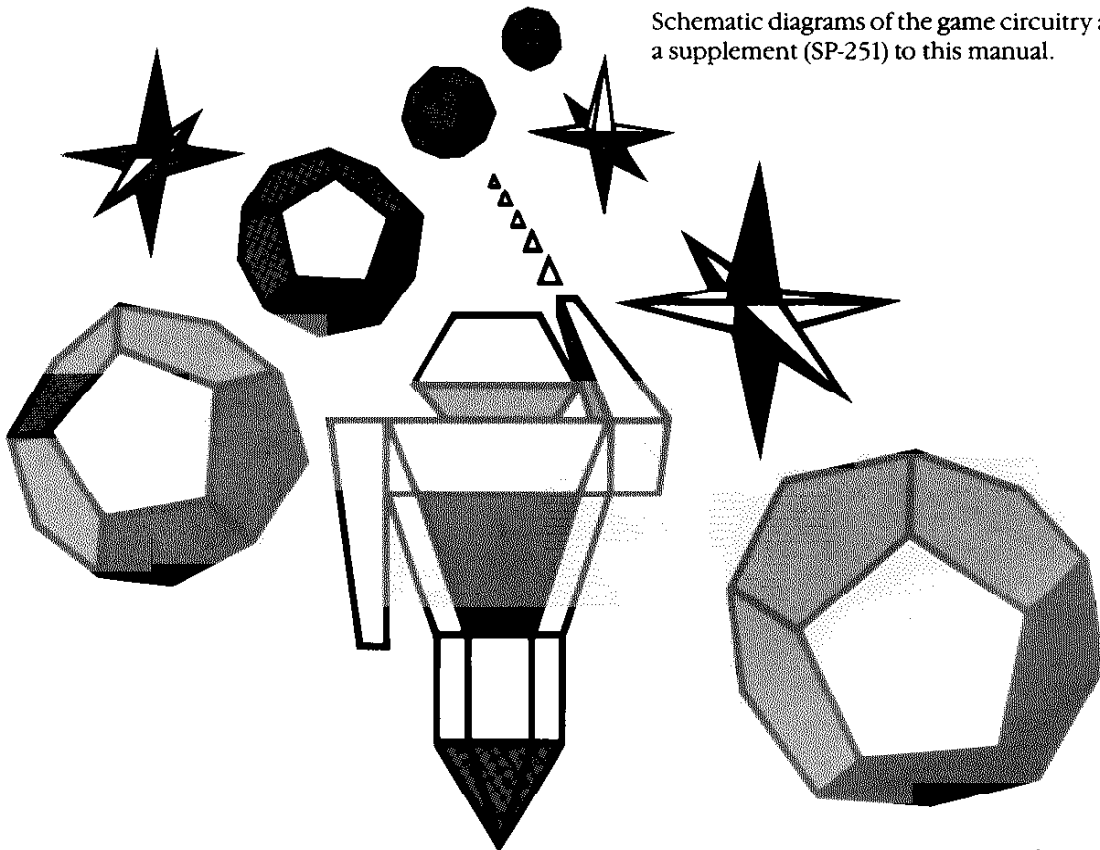

Chapter 1

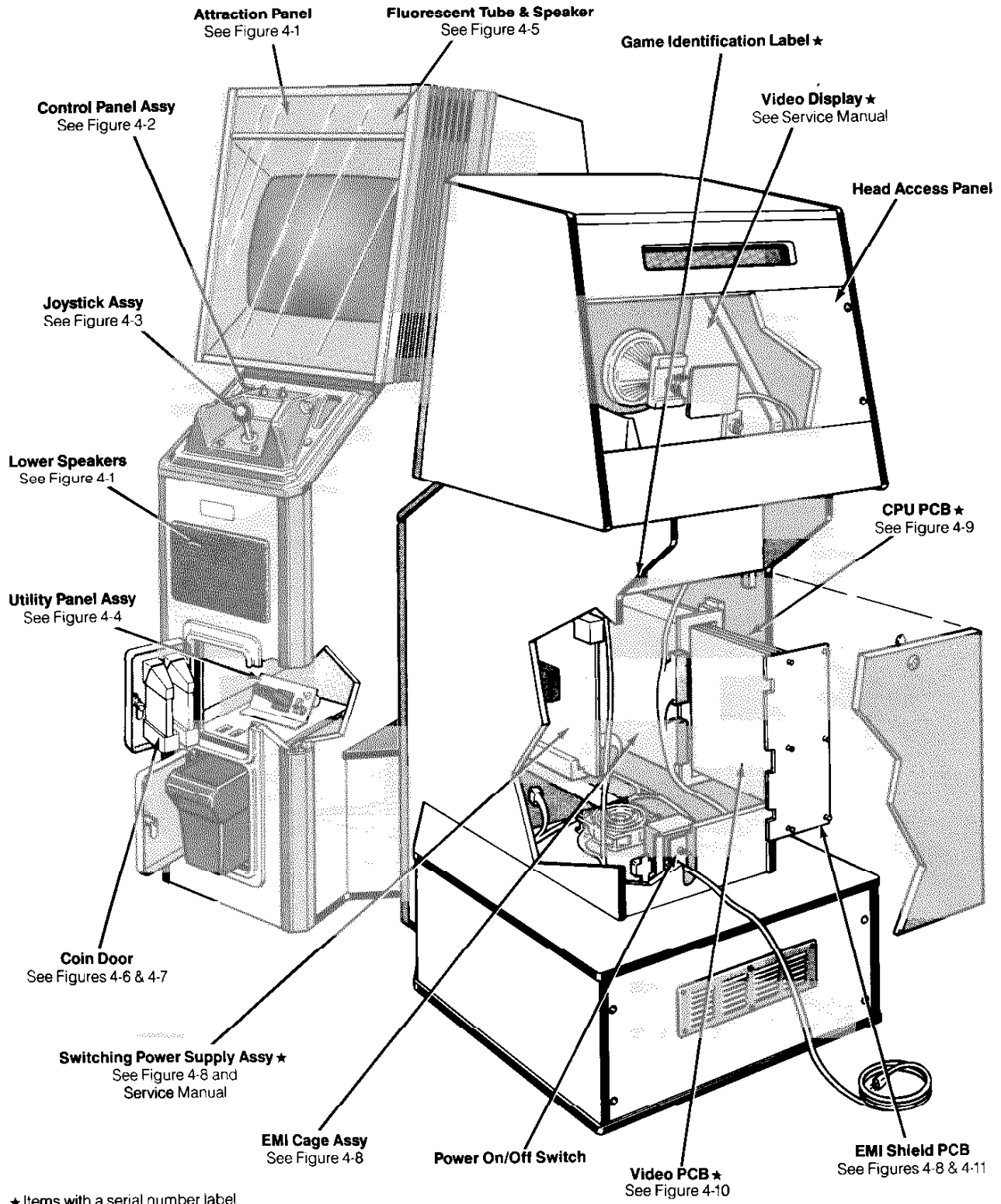

Figure 1-1 Game Overview

Game Overview

The player is an Interface Robot (#1984) in rebellion against Big Brother and his Evil Eyes in I, ROBOT. Players will enter another world where they must face off against Big Brother on different terrains, trying to shoot through a protective shield and advance to the pyramid where Big Brother's Evil Eye can actually be shot and destroyed. I, ROBOT provides players with exciting challenges as they attempt to lead a rebellion against the control of Big Brother.

New Features

I, ROBOT has several new features:

- **Changing Perspective.** By pressing the start push-button while in Game Play, players can change their viewpoint on the playfield. It takes them from an overhead view of the entire terrain to a ground-level view, where shooting the enemy is worth more points.
- **3-Dimensional Graphics.** All objects in I, ROBOT are really three-dimensional.
- **Doodle City.** By entering the Transporter, players can go to *Doodle City*. The players can manipulate the I, ROBOT graphics in an infinite variety of shapes, colors, and patterns.
- **Hall-Effect Joystick.** This new analog joystick provides a faster and smoother response for the player.

All major parts of the game are illustrated in Figure 1-1.

Inspecting the Game

Please inspect your game carefully to ensure that it was delivered to you in good condition.

1. Examine the exterior of the game cabinet for dents, chips, or broken parts.
2. Remove the screws from the body rear access panel. Unlock and open this panel and the coin door. Inspect the interior of the game as follows:
 - a. Ensure that all plug-in connectors (on the game harnesses) are firmly plugged in. Replug any connectors found unplugged. Do not force connectors together. The connectors are keyed so they only fit in the proper orientation. *A reversed edge connector may damage a printed-circuit board (PCB) and will void your warranty.*
 - b. Ensure that all plug-in integrated circuits on each PCB are firmly plugged into their sockets.

- c. Remove the tie-wrap that secures the coiled power cord inside the cabinet. Inspect the power cord for any cuts or dents in the insulation. Repair or replace it as required. Place the square strain-relief plate in the wood slot at the bottom of the rear panel opening.
- d. Inspect the power supply. Make sure the harness is plugged in correctly.

WARNING

Replace fuses only with an identical type fuse with the same electrical rating. Please refer to TM-261 (the switching power supply manual) for information about fuse values in your game.

- e. Inspect other major subassemblies, such as the control panel, video display, EMI cage, and each PCB. Make sure they are mounted securely and that the green ground wires are connected.

NOTE

Before applying power to the game, make sure the joystick is resting in the middle of its housing. If it is not, the electrical centering of the joystick may be disrupted.

- f. Plug the game into a grounded 3-wire outlet. Perform a self-test as described in Chapter 2.

Table 1-1 Installation Specifications

Characteristic	Specification
Power Consumption	240 W Nominal
Temperature	+5° to +38° C (+37° to +100° F)
Humidity	Not to exceed 95% relative
Line Voltage	100 to 240 VAC
Width	25.25 in (64.1 cm)
Depth	36 in (91.5 cm)
Height	68.5 in (174 cm)

Joystick Centering

Electrical centering for the joystick is quickly accomplished by moving the joystick to all four extreme edges. Electrical centering is also accomplished during normal game play, but may take a few seconds to optimize.

Switch Locations

Power On/Off Switch

The power on/off switch is located on the back of the cabinet on the lower left side (see Figure 1-1).

Utility Panel Switches

The volume control, coin counter(s), self-test switch, and auxiliary coin switch are on the utility panel. The utility panel is located inside the upper coin door (see Figure 1-1). The volume control adjusts the level of sound produced by the game. The coin counter(s) records the number of coins entered into the game. The self-test switch initiates the self-test mode. The auxiliary coin switch credits the game without activating a coin counter. See Figures 1-2 and 4-4 for details of these switches.

Option Switches

Two dual-inline package (DIP) switches are located on the Central Processing Unit (CPU) PCB at locations 3J and 5E (see Figure 1-2). Use these 8-toggle switches to select different bonus, pricing, and play options.

Selecting the Options

Settings of the option switches are explained in Tables 1-2 and 1-3. Options preset at the factory are shown by the ◀ symbol. However, you may change the settings to suit your individual needs.

Table 1-2 describes the settings for the 8-toggle switch at location 5E on the CPU PCB. This switch selects both the bonus life intervals available and the game play options. Table 1-3 describes the settings for the 8-toggle switch on the CPU PCB at location 3J. This switch selects the game price options available and the bonus adder. To verify option settings, refer to Chapter 2.

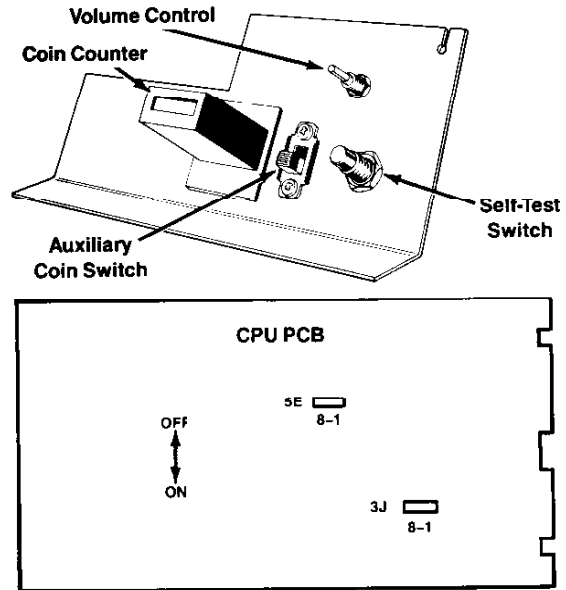

Figure 1-2 Switch Locations

Table 1-2 Switch Settings for Bonus Interval and Play Options

Settings of 8-Toggle Switch on CPU PCB (at location 5E)								Option
1	2	3	4	5	6	7	8	
				On	Off			Bonus Life Intervals
				On	On			None
				Off	Off			20,000 ◀
				Off	On			30,000
								50,000
		Off	On					Bonus Lives Per Coin
		Off	Off					5 Lives
		On	On					4 Lives
		On	Off					3 Lives ◀
								2 Lives
							Off	Minimum Game Time Option
							On	90 Second Minimum Game Time on Level 1
							Off	3 Lives (Limited Game Time) ◀
		On						Medium Difficulty Level ◀
		Off						Easy Difficulty Level
								Demonstration Mode On
								Demonstration Mode Off ◀
Off							On	Doodle City for 2 Minutes 10 Seconds ◀
On							Off	Doodle City for 3 Minutes 5 Seconds

◀Manufacturer's recommended settings for American-made games.

Table 1-3 Switch Settings for Coin & Credit Options and Bonus Adder

Settings of 8-Toggle Switch on CPU PCB (at location 3J)								Option
1	2	3	4	5	6	7	8	
				On	On			Right Coin Mechanism
				On	Off			1 Coin for 1 Coin Unit ◀
				Off	On			1 Coin for 4 Coin Units
				Off	Off			1 Coin for 5 Coin Units
								1 Coin for 6 Coin Units
			On					Left Coin Mechanism
			Off					1 Coin Unit for 1 Credit ◀
								1 Coin Unit for 2 Credits
						On	On	Coins Per Credit
						On	Off	1 Coin for 1 Credit ◀
						Off	On	2 Coins for 1 Credit
						Off	Off	3 Coins for 1 Credit
						Off	Off	4 Coins for 1 Credit
On	On	On						Bonus Adder
On	On	Off						No Bonus ◀
Off	On	Off						2 Coin Units for 1 Credit
On	Off	On						3 Coin Units for 1 Credit
Off	On	On						4 Coin Units for 1 Credit
On	Off	Off						5 Coin Units for 1 Credit
Off	Off	On						4 Coin Units for 2 Credits
Off	Off	Off						No Bonus
								Free Play

◀Manufacturer's recommended settings for American-made games.

Game Play

NOTE

The message *TEST AND CENTER JOYSTICK* may appear during game play. If this occurs, enter the self-test mode (see Chapter 2) and center the joystick.

I, ROBOT begins with the Interface Robot facing off against the Evil Eye. The player has to collect all of the red squares on the playfield in order to destroy the shield that protects the Evil Eye and enter the pyramid. The Robot can only jump to the red squares when the Evil Eye is not watching (i.e., yellow or green). If the Evil Eye is red, it will detect the Robot jumping and destroy him. At the acquisition of each red square, the protective shield is weakened. When the Robot has obtained all of the red squares, the shield is automatically destroyed and the Robot can get into the pyramid and destroy the Evil Eye.

After the destruction of the Evil Eye, the Robot travels through a space wave where the player must either shoot and destroy or avoid the objects flying towards him.

At the completion of each space wave, the Robot lands on another geometric terrain, where once again he must face another Evil Eye.

Every third terrain contains a red pyramid which the Robot must enter after destroying the Evil Eye. Once inside the pyramid, the Robot has one chance to collect as many of the jewels as he can before he is destroyed. If the Robot is destroyed while inside the pyramid, he is immediately thrust back into space. The player must get through three more terrains, and destroy three more Evil Eyes before he has another chance to get the jewels inside of the pyramid.

Hints for Game Play

- The player can advance to higher play levels while inside the Transporter.
- Objects to be destroyed for points include a buzz saw, a soccer ball, a small ball dropped by a bird, the polygons, and a rolling log.
- The player can achieve a bonus for shooting all of the tetrahedrons in a space wave. The player can also achieve bonus points by spelling *I ROBOT* by shooting the letters as they appear sequentially in space waves.
- The player must shoot the polygons with SEVEN shots in order to destroy them and achieve points.

Self-Test Procedure

This game will test itself and provide data to show that the game circuitry and controls are operating properly. Self-test data is presented visually on the video display and audibly through the speakers. No additional equipment is required.

We suggest you perform a self-test when you first set up, each time you collect money, change the game options, or suspect game failure.

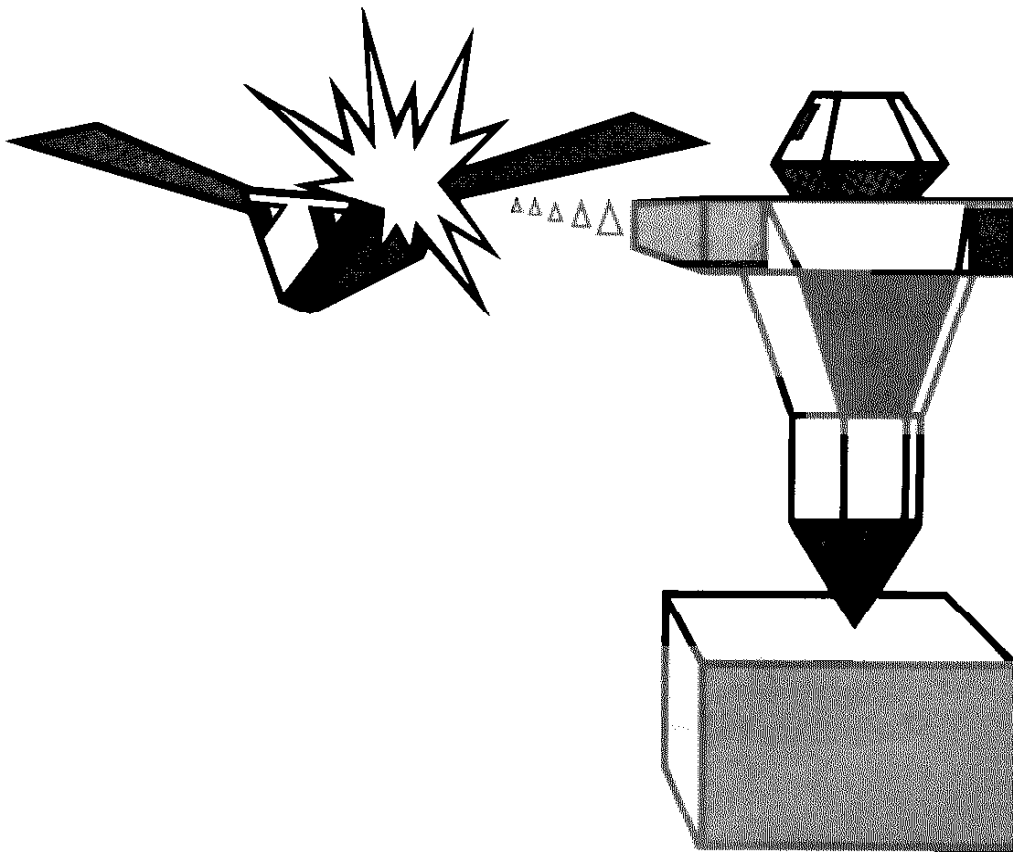

Self-Test Displays

Ten self-test displays provide a visual check of the following:

- Game accounting and option-switch information.
- Read-only memory (ROM) and random-access memory (RAM) circuit operation.
- Joystick and switch operation.
- Sound-generator circuit operation.
- Mathbox circuit operation.
- The Dot-, vector-, and polygon-generator circuit operation.
- Character-generator circuit operation.
- Display operation.

When the self-test switch (located on the utility panel behind the coin door) is turned on, the game enters the Self-Test Mode. The following self-test displays are arranged in the sequence in which they occur after the self-test switch is turned on. After Screen 10—Size and Centering, the sequence starts over with Screen 2—Hardware and Switch Test. Turn the self-test switch off then on again to obtain Screen 1—Accounting and Options.

Screen 1—Accounting and Options

The Accounting and Options screen, as shown in Figure 2-1, displays the accounting information and the option settings. The totals in the Accounting section of Screen 1 are those accumulated since the game was first turned on or last reset.

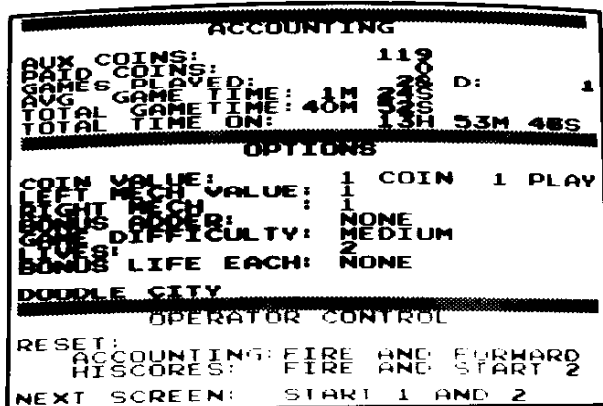

Figure 2-1 Accounting and Options

The following information is displayed in the Accounting section of Screen 1:

- *AUX COINS* shows the number of free coins selected by the auxiliary coin switch in the normal play mode.
- *PAID COINS* shows the total number of coins inserted into both game coin mechanisms.
- *GAMES PLAYED* shows the total number of free and paid games played. The number of Doodle City games played appears as *D: XXXX* on the same line. Add the Doodle City number to the number on the left to obtain the total games played.
- *AVG GAME TIME* shows the average time, in minutes and seconds, of all the games played.
- *TOTAL GAME TIME* shows the total time, in hours, minutes, and seconds, of all the games played.
- *TOTAL TIME ON* shows the total time, in hours, minutes, and seconds, the game has been on.

Resetting the Accounting Information. The accounting information can be reset by simultaneously holding the FIRE button down and pushing the joystick forward.

Resetting the High Scores. We suggest that you reset the high-score table after any changes are made to the options that may affect the average game time. The high-score table displayed in the Attract Mode can be reset by simultaneously pressing the FIRE and Start 2 buttons.

Changing the Options. The Options section of Screen 1 shows the current option-switch settings. The options can be changed by resetting the option switches located on the central-processing unit (CPU) printed-circuit board (PCB). Refer to Chapter 1 for option-switch information.

Simultaneously press the Start 1 and 2 buttons to obtain Screen 2.

Screen 2—Hardware and Switch Test

Screen 2 is divided into two sections: Hardware Test and Switch Test. The Hardware Test section is divided into two segments that show the condition of the ROM and RAM circuits. If the hardware test passes, the message *ROM OK* will appear in the top segment and *RAM OK* will appear in the bottom segment as shown in Figure 2-2.

If the ROM test fails, the top segment of the Hardware Test section will give the location of the ROM circuit that failed; the bottom segment will be blank as shown in Figure 2-3. If the RAM test fails, the bottom segment will show the following error messages:

NOTE

An oscilloscope sync pulse is available to aid in troubleshooting the mathbox and video processor circuits. Perform the procedures described in the following description for the *MB ERRORS XX* and *VP WONT STOP* messages.

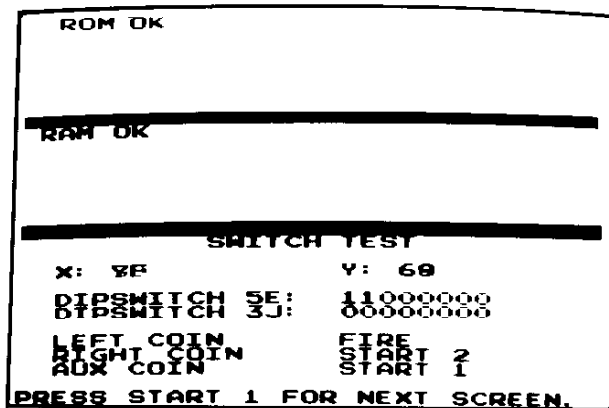

Figure 2-2 Hardware Test—Passes

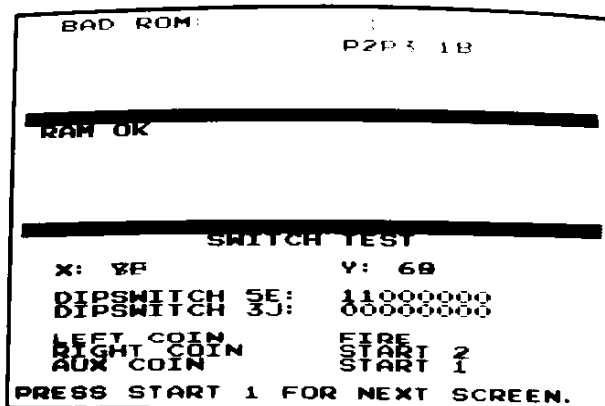

Figure 2-3 Hardware Test—Fails

- *EEROM CLEARED* indicates that there is a new EEROM at location 4B on the CPU PCB.
- *EEROM BAD* indicates that the EEROM at location 4B on the CPU PCB has failed.
- *MB ERRORS XX* indicates that there is either bad data or a timeout problem with the Y, P, R, or C functions in the mathbox circuit on the CPU PCB. The mathbox will count from 00 to 99 and then repeat. The count will stop when the fault is corrected.

To aid in troubleshooting the mathbox circuit, the mathbox can be pulsed to provide an oscilloscope sync signal. Press the Start 2 button to pulse the mathbox. Connect the oscilloscope sync input to pin 10 on the integrated circuit at location 9L on the CPU PCB. Press the FIRE button to stop the pulse mode.

- *BAD QP* indicates that the custom sound IC at location 4E on the CPU PCB has failed.
 - *NO IRQS* indicates that the interrupt-request circuit on the CPU PCB has failed.
 - *VP WONT STOP* indicates that the video processor circuit on the Video PCB has failed.
- To aid in troubleshooting the video processor circuit with an oscilloscope, press the Start 1 button to obtain Screen 7—Dot, Vector, and Polygon Test. Perform the procedure described under Screen 7—Dot, Vector, and Polygon Test.
- *NO VBLANK* indicates that the vertical-blanking circuit on the Video PCB has failed.
 - *BAD RAM* followed by a descriptor, an address, and a bit pattern (e.g., *CO 2010 WXX RYY*) indicates that there is a bad address (2010) or bit pattern (WXX RYY) at the RAM indicated by the descriptor (CO). WXX is the bit pattern written to address 2010 and RYY is the bit pattern read from address 2010. An error message with two descriptors and addresses (e.g., *BAD RAM MA 2001 CO 2010*) indicates that the two addresses are shorted together. Refer to Table 2-1 to locate the RAMs identified by the descriptor. The RAM locations in Table 2-1 are listed in the order in which they are tested.

Table 2-1 RAM Locations

Descriptor	Location	Description
W0	2A, 2B, 3A, 3B (CPU PCB)	Working RAM (800–FFF page 0, 0–7FF unpagcd)
W1	2A, 2B, 3A, 3B (CPU PCB)	Working RAM (800–FFF page 1)
W2	2A, 2B, 3A, 3B (CPU PCB)	Working RAM (800–FFF page 2)
MA	1N, 1P, 2N, 2P (CPU PCB)	Math RAM (communication with mathbox)
CO	1C, 1D (Video PCB)	Communication RAM 0 (communication with video processor)
CI	2C, 2D (Video PCB)	Communication RAM 1 (communication with video processor)
AL	2M, 2N (CPU PCB)	Alphanumeric RAM

The Switch Test section of Screen 2 shows the condition of the joystick, dual-inline package (DIP) option, coin, start, and FIRE switches. The X- and Y-hexadecimal numbers show the horizontal and vertical range of the joystick control. The joystick is electrically centered and checked for the proper horizontal and vertical range in Screen 4—Joystick Test 2.

The DIP option-switch settings at location 5E on the CPU PCB are shown by the top group of eight digits on the right side of the screen. The bottom group of eight digits show the settings of the option switches at location 3J on the CPU PCB. The digits begin with switch 1 on the left and are numbered sequentially to switch 8 on the right (a 0 indicates that the switch is off, a 1 indicates that the switch is on).

The coin, start, and FIRE switch readouts change color as each switch is pressed to indicate proper operation.

Press the Start 1 button to obtain Screen 3.

Screen 3—Joystick Test 1

The Joystick Test 1 screen, as shown in Figure 2-4, displays the condition of the joystick. Press the FIRE button to start the test. The messages *WAIT WHILE TEST OCCURS* and *DO NOT TOUCH JOYSTICK* will appear. The test is completed after 10 seconds. If the test passes, the message *GOOD STABILITY* will appear and the display will automatically proceed to Screen 4—Joystick Test 2.

If the test fails, the message *BAD STABILITY* will appear to indicate an unstable joystick circuit. If desired, press the Start 2 button to obtain Screen 4.

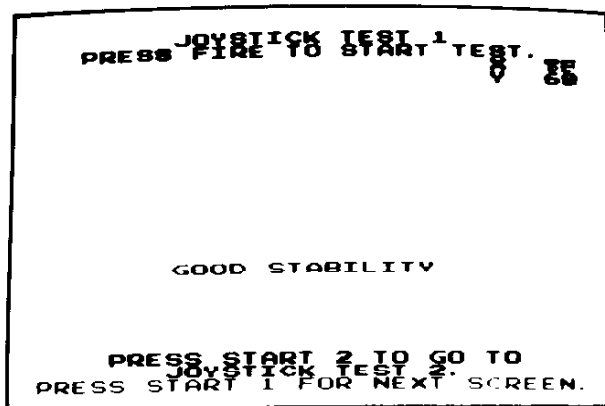

Figure 2-4 Joystick Test 1

Screen 4—Joystick Test 2

The Joystick Test 2 screen, as shown in Figure 2-5, is used to electrically center the joystick and verify that the control range is within acceptable limits. The message *BAD VERTICAL/HORIZONTAL CENTER* indicates a faulty joystick or associated circuitry. Repair the fault before proceeding with this test.

Move the joystick around its extreme outside mechanical limits and check that the flashing box draws a continuous dotted frame around the outside of the yellow box. Move the joystick and completely fill in the area inside the dot-

ted frame with dots. Check that the dot pattern is continuous and uniform without gaps.

Press the FIRE button to go back to Screen 3—Joystick Test 1, or press the Start 1 button to obtain Screen 5.

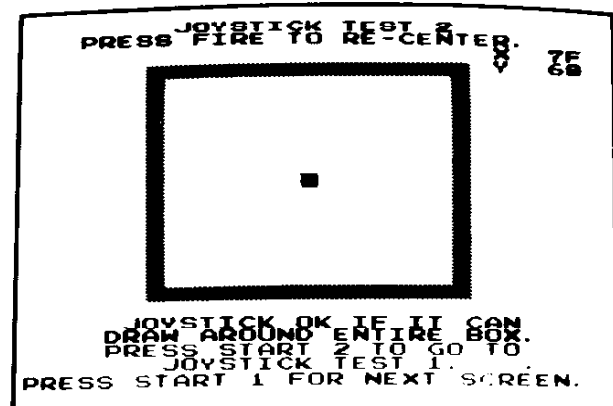

Figure 2-5 Joystick Test 2

Screen 5—Sound Test

The Sound Test screen, as shown in Figure 2-6, is used to verify that the sound microprocessor and associated circuitry is operating properly. Use the joystick to select the sounds (not all are used during game play). Press the FIRE button to start the sound.

Press the Start 1 button to obtain Screen 6.

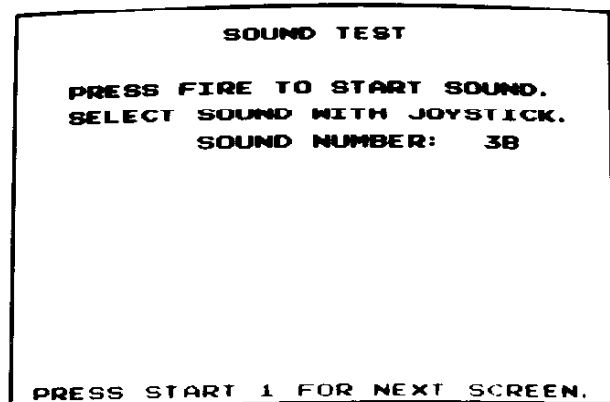

Figure 2-6 Sound Test

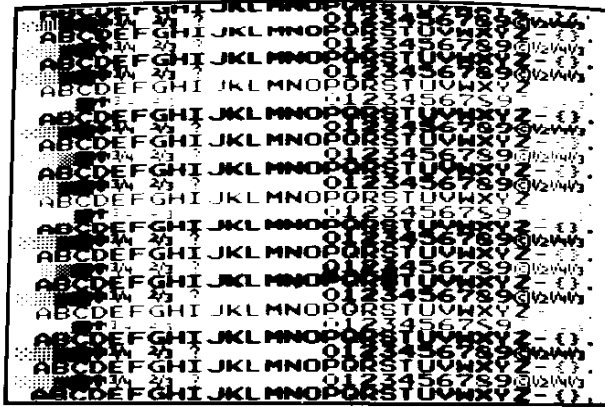

Figure 2-7 Alphanumerics

Screen 6—Alphanumerics

The Alphanumerics screen, as shown in Figure 2-7, is used to verify that the alphanumeric character-generator circuits are operating properly.

Press the Start 1 button to obtain Screen 7.

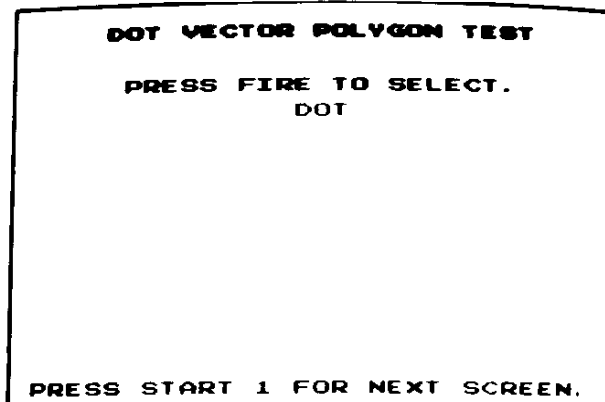

Figure 2-8 Dot, Vector, and Polygon Test

Screen 7—Dot, Vector, and Polygon Test

The Dot, Vector, and Polygon Test screen, as shown in Figure 2-8, is used to verify that the dot-, vector-, and polygon-generator circuits are operating properly. Press the FIRE button to select a dot, vector, or polygon display.

To aid in troubleshooting the video processor, the video processor can be pulsed to provide an oscilloscope sync signal. Press the Start 2 button to pulse the video processor. Connect the oscilloscope sync input to pin 12 on the integrated circuit at location 4R on the Video PCB. Press the FIRE button to stop the pulse mode.

Press the Start 1 button to obtain Screen 8.

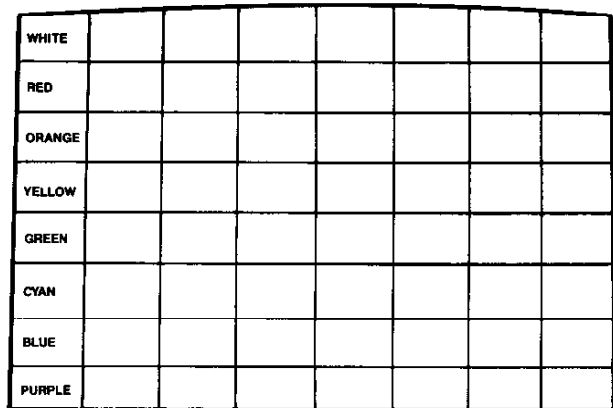

Figure 2-9 Color Bars

Screen 8—Color Bars

The Color Bars screen, as shown in Figure 2-9, is used to verify that the video circuits are operating properly and the display is adjusted for the appropriate colors. The display should contain eight distinct horizontal rows of color bars with eight different shade segments in each color bar. Examine the Color Bars display for the following characteristics:

- The eight color bars (from top to bottom) should be white, red, orange, yellow, green, cyan, blue, and purple. Each color bar should contain eight separate segments of progressively lighter shades of the same color.
- All of the color bars should have the same relative intensity.

If the preceding display characteristics are not correct, refer to the Display Manual for the appropriate adjustment procedure or to determine the possible cause of failure.

Press the Start 1 button to obtain Screen 9.

Screen 9—Grid Pattern

The Grid Pattern screen, as shown in Figure 2-10, is used to verify that the display linearity and convergence are properly adjusted. Examine the grid pattern for the following characteristics:

- Grid lines should exhibit no pincushioning or barreling and the lines should be straight within $\frac{1}{8}$ inch.
- Convergence should not exceed 2.0 mm.

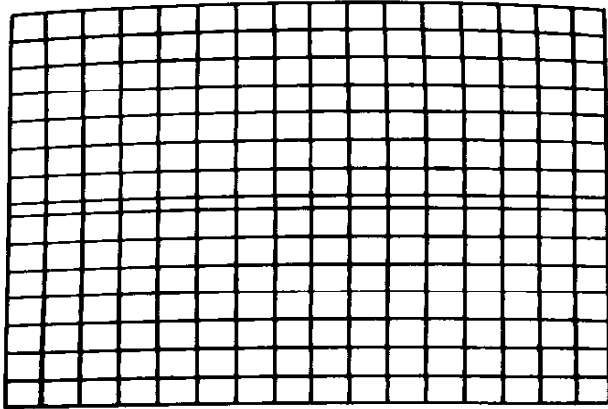

Figure 2-10 Grid Pattern

If the display characteristics are not within limits, refer to the Display Manual for the linearity and convergence adjustment procedures or to determine the possible cause of failure.

Press the Start 1 button to obtain Screen 10.

Screen 10—Size and Centering

The Size and Centering screen, as shown in Figure 2-11, is used to verify that the screen size and centering is within acceptable limits. The displayed frame should be within $\frac{1}{4}$ inch from the edges of the screen on all four sides. If not, refer to the Display Manual for the size and centering adjustment procedures.

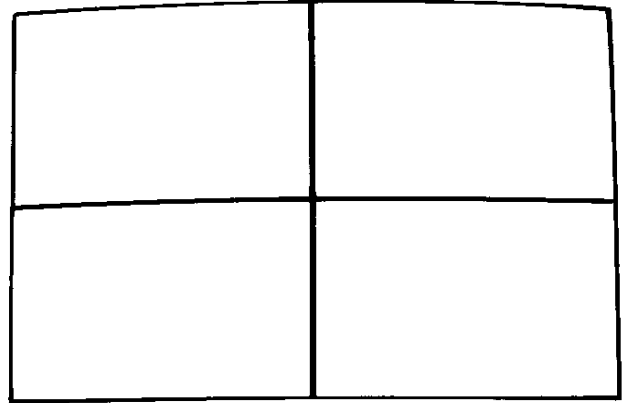

Figure 2-11 Size and Centering

NOTE

Press the Start 1 button after Screen 10—Size and Centering, to repeat the self-test sequence beginning with Screen 2—Hardware and Switch Test. If desired, turn the self-test switch off then on again to obtain Screen 1—Accounting and Options. Do not move the joystick when turning the self-test switch off or on.

Maintenance

This chapter includes preventive and corrective maintenance procedures for the Hall-Effect joystick control and the Start and FIRE pushbutton switches. To assure maximum trouble-free operation from these controls, Atari recommends that periodic preventive maintenance be performed as described in this chapter. If the controls require removal or replacement, refer to the Corrective Maintenance section of this chapter for the recommended procedures.

References are made to Chapter 4 Illustrated Parts Lists, to aid in locating the parts that are mentioned, but not illustrated, in the following maintenance procedures.

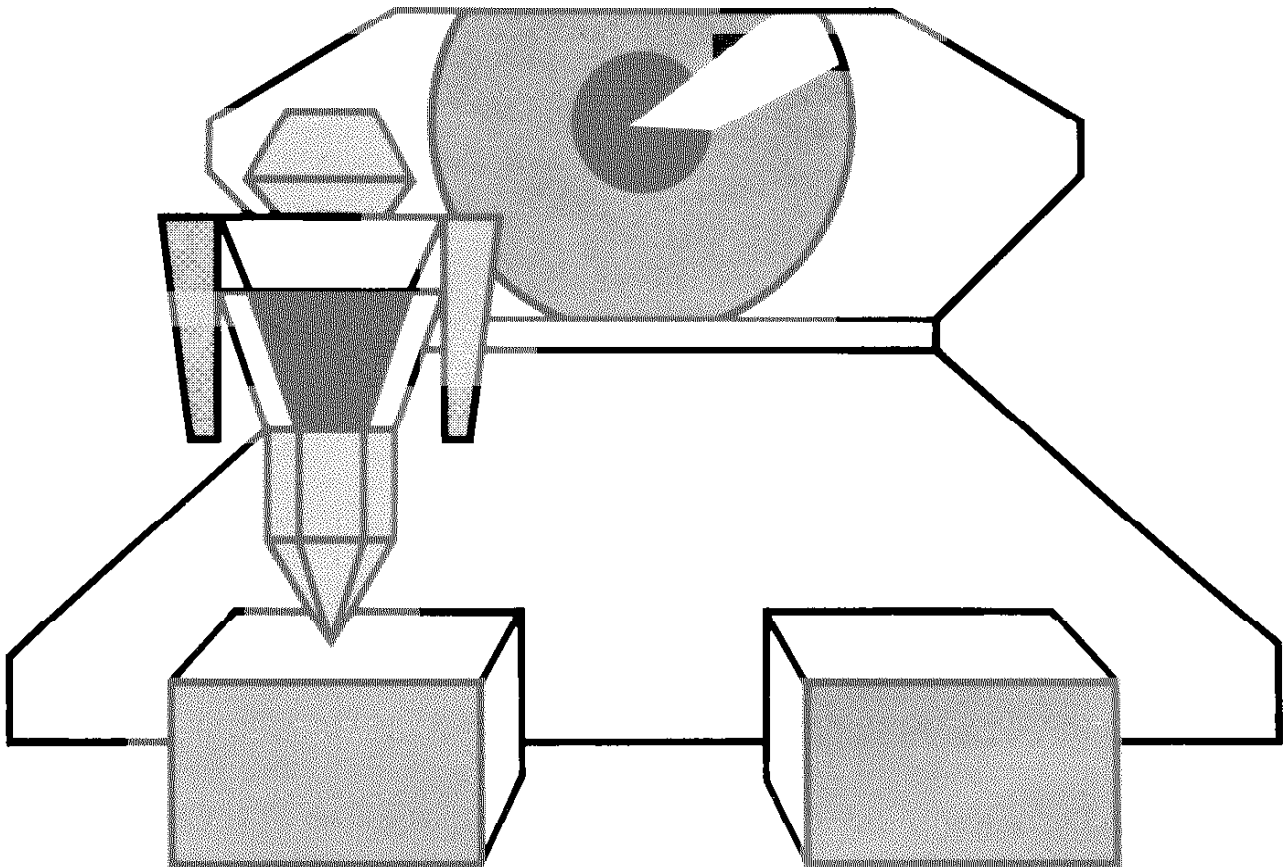

Chapter 3

Preventive Maintenance

Preventive maintenance includes cleaning, lubricating, and tightening the securing hardware. For maximum trouble-free operation, preventive maintenance should be performed at the intervals specified in Table 3-1.

Table 3-1 Recommended Preventive-Maintenance Intervals

Control	Maintenance Interval
Joystick Control	Lubricate joystick and tighten securing hardware at least every four months.
FIRE Switches	Clean switch contacts and tighten securing hardware at least every four months.
Start Switches	Tighten securing hardware at least every six months.

WARNING

To avoid possible electrical shock, unplug the game power before performing any preventive maintenance procedures.

Removing the Control Panel

Perform the following procedure to remove the control panel from the cabinet (see Figure 4-2).

1. Turn the game power off.
2. Open the coin door.
3. Reach up through the coin door opening and release the two spring-draw latches located under the control panel on either side of the game cabinet.
4. Grasp the front edge of the control panel and lift just far enough to expose the control-panel harness connector.
5. Disconnect the control-panel harness connector and remove the control panel from the cabinet.
6. Replace the control panel in the reverse order of removal.

Lubricating the Joystick Control

Perform the following procedure to lubricate the joystick control and tighten the securing hardware (see Figures 3-1 and 4-2).

1. Remove the control panel as previously described.
2. Using a $\frac{7}{16}$ -inch hex driver tighten the four nuts securing the joystick assembly to the adjustable mounting plate (see Figure 4-2).
3. Using a Phillips screwdriver tighten the four screws securing the adjustable mounting plate to the control-panel brackets (see Figure 4-2).
4. Disconnect the four-pin connector from the Hall-Effect printed-circuit board (PCB).
5. Using a Phillips screwdriver remove the two screws securing the PCB to the Hall-Effect positioner plate.
6. Using a $\frac{1}{4}$ -inch hex driver remove the four screws securing the lower Hall-Effect housing and positioner plate to the upper housing assembly.
7. Remove the actuator and the X/Y direction slides.
8. Apply a small amount of lithium-base grease (part no. 107027-001) to the actuator and X/Y direction slides as shown in Figure 3-1.
9. Apply a small amount of lithium-base grease to the plunger, pivot ball, and actuator ball on the joystick shaft as shown in Figure 3-1. Press the joystick control knob down to compress the spring and expose the contact surfaces of the pivot ball and plunger.
10. Reassemble the joystick as described under *Reassembling the Joystick Control* in the Corrective Maintenance section of this chapter.

Cleaning the FIRE Switches

Perform the following procedure to clean the FIRE switch contacts and tighten the securing hardware.

1. Remove the control panel as previously described.
2. Using electrical contact cleaner clean the switch contacts. When the FIRE button is pressed, the wiping action of the cross-bar contacts provides a self cleaning feature. Do not burnish the contacts.
3. Using a $\frac{5}{8}$ -inch open-end wrench tighten the stamped nut securing the FIRE switches to the control panel.

Tightening the Start Switches

The start switch contacts are sealed inside the switch housing and do not require cleaning. Tighten the start switches by firmly holding the black cone shaped bushing on the front of the control panel while turning the switch housing clockwise.

Corrective Maintenance

Corrective maintenance consists of removal, disassembly, reassembly, and replacement of the joystick control, and the Start and FIRE switches.

WARNING

To avoid possible electrical shock, unplug the game before performing any corrective maintenance procedures.

Removing the Joystick Control

Perform the following procedure to remove the joystick control from the control panel (see Figure 4-2). Refer to *Disassembling the Joystick Control* for detailed disassembly procedures.

1. Remove the control panel as described in the Preventive Maintenance section of this chapter.
2. Disconnect the four-pin connector from the Hall-Effect PCB.
3. Using a $\frac{7}{64}$ -inch hex driver remove the four nuts securing the joystick control to the adjustable mounting plate.
4. Carefully lift the joystick control from the adjustable mounting plate.
5. Replace the joystick control in the reverse order of removal.

Disassembling the Joystick Control

Perform the following procedure to disassemble the joystick control (see Figure 3-1). If necessary, remove the joystick control from the cabinet as previously described.

1. Using a Phillips screwdriver remove the two screws securing the Hall-Effect PCB to the positioner plate.

CAUTION

The position of the Hall-Effect sensors on the Hall-Effect PCB is critical. Avoid bending these sensors when handling the PCB.

2. Using a $\frac{1}{4}$ -inch hex driver remove the four screws securing the Hall-Effect positioner plate and lower Hall-Effect housing to the upper housing assembly.

3. Separate the lower housing and the positioner plate from the upper housing assembly.
4. Remove the actuator and the X/Y direction slides.
5. Gently press the magnets out of the clips in the X/Y direction slides. Do not drop the magnets.

NOTE

The following steps describe the procedure for disassembling the upper housing assembly.

6. Using a metal punch remove the 0.086-inch roll pin securing the actuator ball to the shaft.
7. Using a metal punch remove the $\frac{1}{8}$ -inch roll pin securing the pivot ball to the shaft.
8. Slide the shaft out of the housing and remove the plunger and spring from the shaft.
9. Reassemble the joystick control as described in the following procedure.

Reassembling the Joystick Control

Perform the following procedure to reassemble the joystick control (see Figure 3-1).

NOTE

If the upper housing assembly was not previously disassembled, proceed to step 11.

1. Slide the disc onto the ball-handle shaft.
2. With the close-wound coils toward the end of the shaft, slide the spring onto the ball-handle shaft.
3. With the bell-shaped end toward the end of the shaft, slide the plunger onto the ball-handle shaft and over the spring.
4. Slide the end of the ball-handle shaft through the top of the lower Hall-Effect housing.
5. Slide the pivot ball onto the ball-handle shaft and align the hole in the shaft (nearest the lower housing) with the hole in the pivot ball.
6. Using a metal punch insert the $\frac{1}{8}$ -inch roll pin through the pivot ball and the ball-handle shaft.
7. With the beveled edge toward the pivot ball, slide the actuator ball onto the end of the ball-handle shaft.

8. Align the hole in the actuator ball with the hole in the end of the ball-handle shaft.
9. Using a metal punch insert the 0.086-inch roll pin through the actuator ball and the ball-handle shaft.
10. Lift the disc, tilt the ball-handle to one side, and apply a small amount of lithium-base grease (part no. 107027-001) to the contact area between the plunger and the upper housing as shown in Figure 3-1.
11. Place the lower Hall-Effect housing over the ball-handle shaft and align the four screw holes in the upper housing with those in the lower housing.
12. With the marked end of the magnet toward the + embossed on the Hall-Effect X-direction slide, insert the magnet into the slide clip.
13. Apply a small amount of lithium-base grease to the two tab pins and the four corners of the X-direction slide as shown in Figure 3-1.
14. Place the X-direction slide on the lower Hall-Effect housing. Make sure the two tab pins are aligned with the housing slots and that the magnet is facing the small □ embossed in the outside edge of the housing.
15. With the marked end of the magnet toward the + embossed on the Hall-Effect Y-direction slide, insert the magnet into the slide clip.
16. Apply a small amount of lithium-base grease to the two tabs and edges of the Y-direction slide and to both sides of the actuator as shown in Figure 3-1.
17. With the magnet facing the small △ embossed on the edge of the lower housing, place the Y-direction slide on top of the X-direction slide.
18. With the beveled hole toward the lower housing, place the actuator over the ball-handle shaft and through the center of the X- and Y-direction slides. Make certain the actuator is inserted through both slides so that the end of the ball-handle shaft is flush with the end of the actuator.
19. Gently place the Hall-Effect positioner plate over the slides so that the magnets and two tabs on the Y-

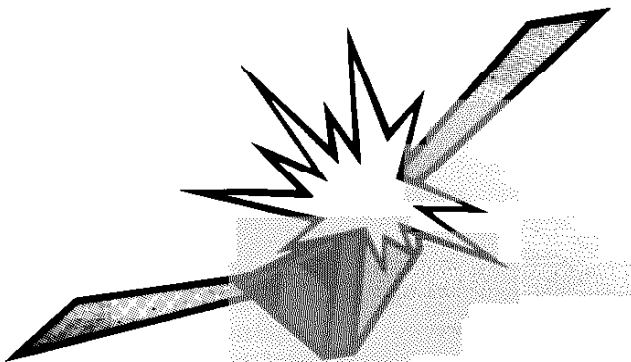

direction slide are aligned with the corresponding slots in the positioner plate. Adjust the positioner plate until the four screw holes are aligned with those in the lower housing.

20. Insert the four 2 ½-inch self-tapping screws into the four screw holes in the positioner plate.
21. Using a ¼-inch hex driver tighten the four screws to 15 in/lbs ± 2 in/lbs. Check that the ball-handle returns freely to the centered position.
22. Check that the two Hall-Effect sensors on the Hall-Effect PCB are perpendicular to the PCB. Place the PCB on the positioner plate so that the sensors are positioned in front of the two magnets installed in the slides.
23. Using a Phillips screwdriver tighten the two ¼-inch self-tapping screws securing the Hall-Effect PCB to the positioner plate.

Removing the Start Switches

Perform the following procedure to remove the start switches from the control panel (see Figure 4-2).

1. Remove the control panel from the cabinet as described in the Preventive Maintenance section of this chapter.
2. Disconnect the wires from the start switch terminals.
3. Firmly hold the black cone-shaped bushing located on the outside of the control panel and turn the switch housing on the inside of the control panel counter-clockwise.
4. Replace the start switches in the reverse order of removal. Refer to Figure 4-2 for the proper wire connections.

Removing the FIRE Switches

Perform the following procedure to remove the FIRE leaf-switch contacts and pushbutton assembly from the control panel (see Figure 4-2).

1. Remove the control panel from the cabinet as described in the Preventive Maintenance section of this chapter.
2. Disconnect the wires from the leaf-switch terminals.
3. Using a Phillips screwdriver remove the screw securing the leaf-switch contacts to the pushbutton assembly.
4. Using a ⅝-inch open-end wrench remove the stamped nut that secures the pushbutton assembly to the control panel.
5. Replace the leaf-switch contacts and pushbutton assembly in the reverse order of removal.

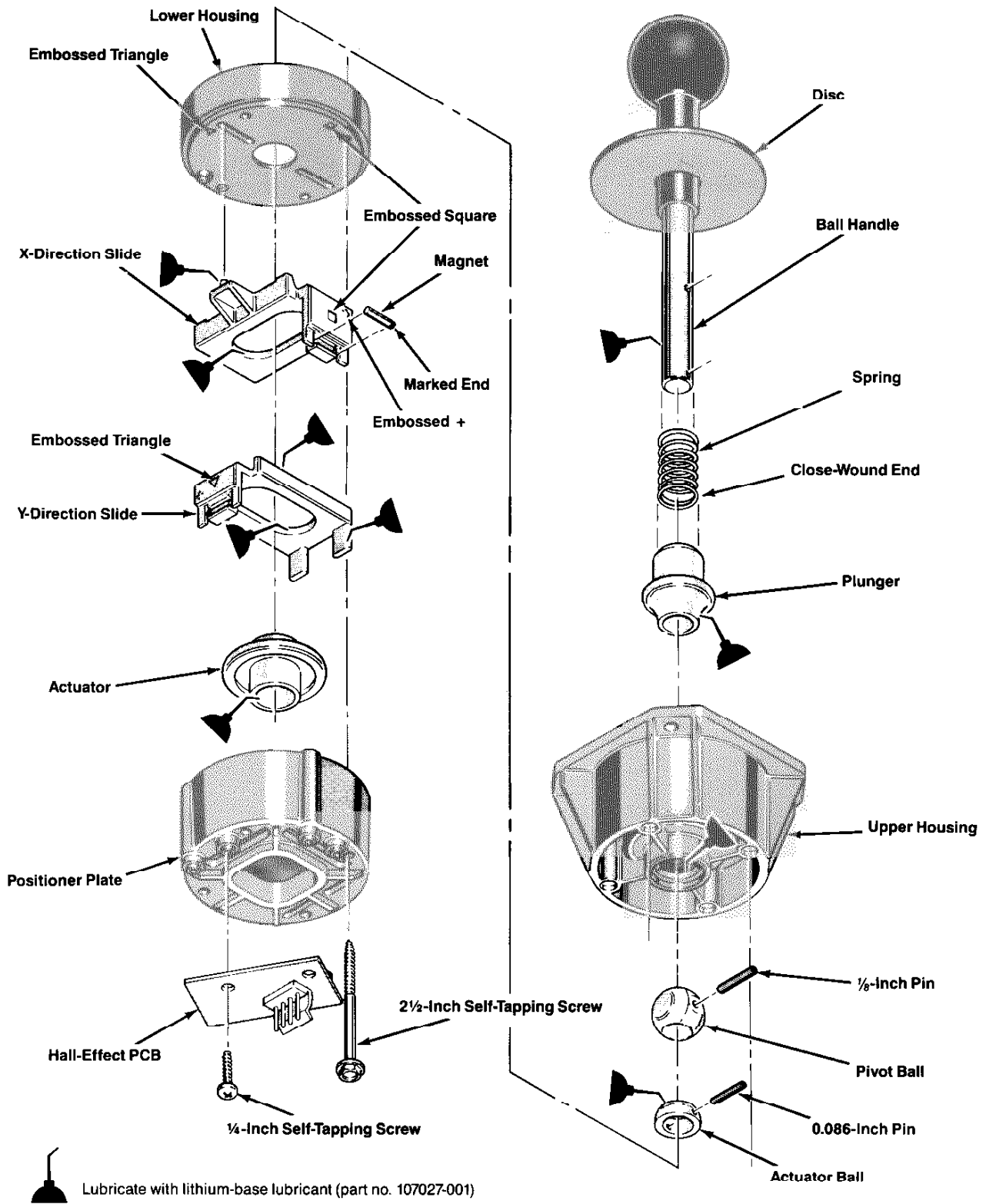
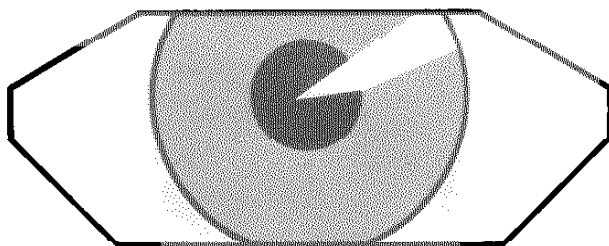

Figure 3-1 Lubricating, Disassembling, and Reassembling the Hall-Effect Joystick



Illustrated Parts Lists

This chapter provides information you need to order parts for your game. Common hardware (screws, nuts, washers, etc.) has been deleted from most of the parts lists. However, a parts list is included for the hardware to mount the printed-circuit boards (PCB) to the cabinet.

The PCB parts lists are arranged in alphabetical order by component. Each component subsection is arranged alphanumerically by reference designator.

Other parts lists are arranged alphanumerically by Atari part number. In these parts lists, all A-prefix numbers come first. Following these are numbers in sequence evaluated up to the hyphen, namely 00- through 99-, then 000598- through approximately 201000-.

When ordering parts, please give the part number, part name, number of this manual, and serial number of your game. This will aid in filling your order rapidly and correctly. We hope the results will be less downtime and more profit from your game.

The Atari Customer Service numbers are listed on the inside front cover of this manual.

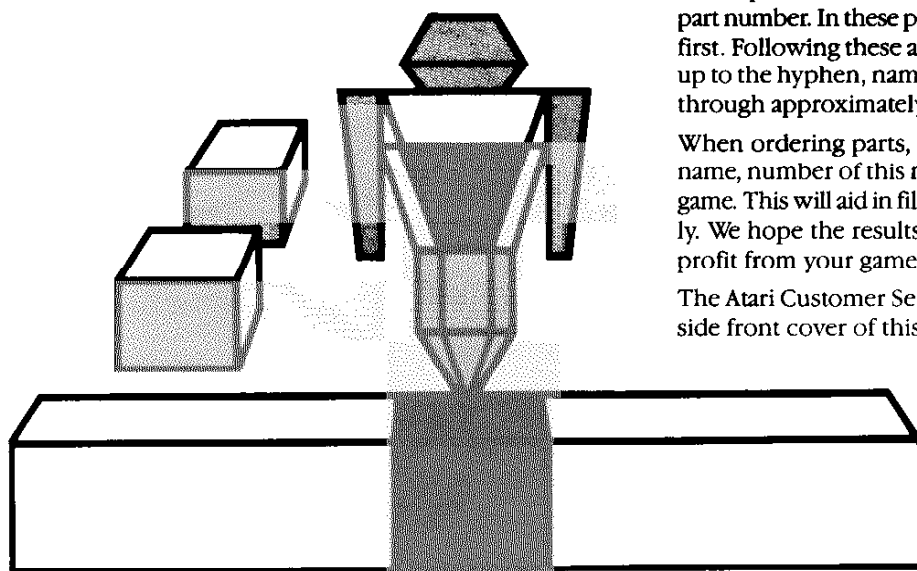

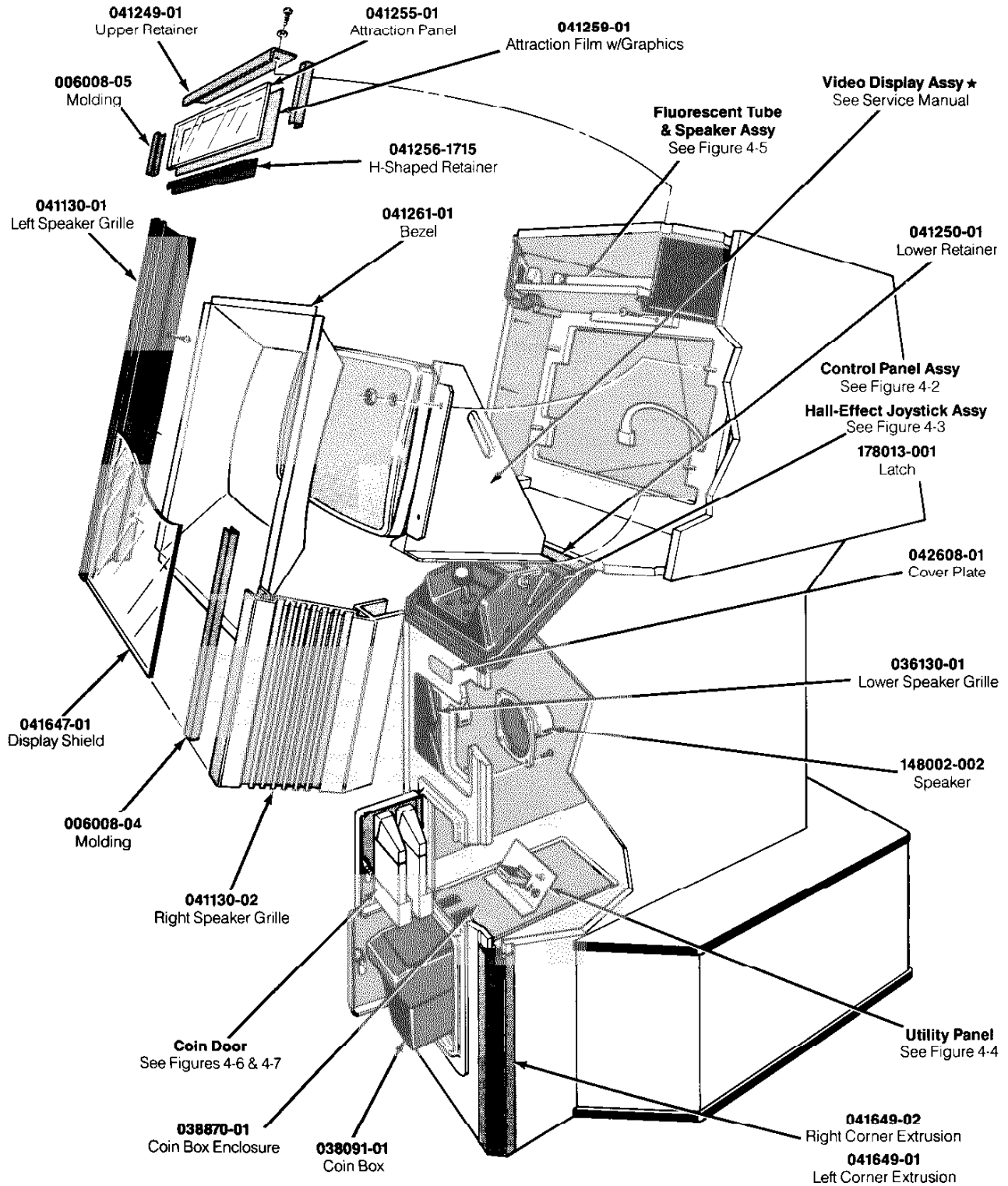

**Figure 4-1 Cabinet-Mounted Assemblies
A042600-xx A**

Game Documentation—
See parts list on next page

A042601-xx
Cabinet Assembly

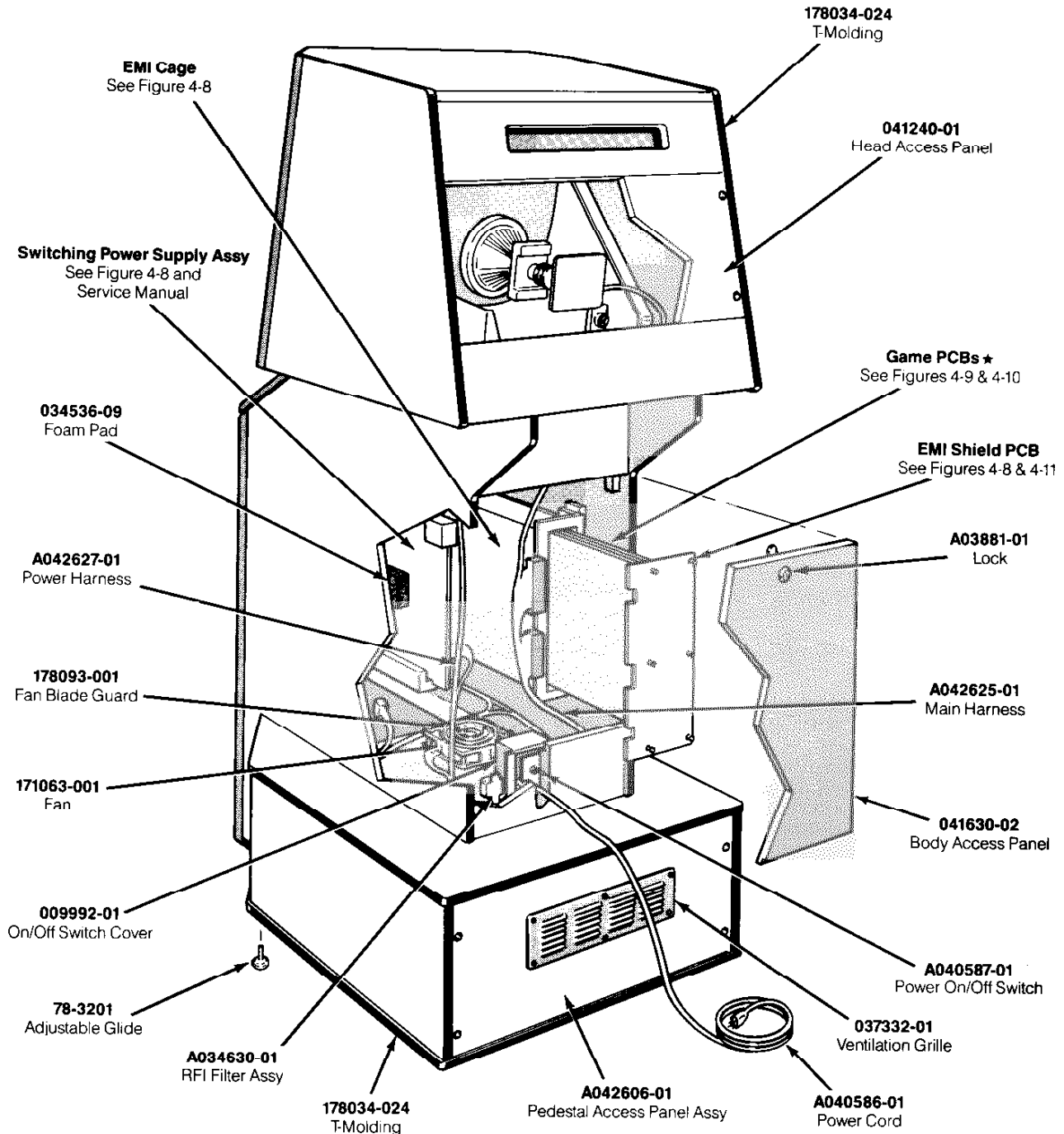

Figure 4-1 Cabinet-Mounted Assemblies, continued
A041600-xx A

Cabinet-Mounted Assemblies Parts List

Part No.	Description
US-Built Cabinet	
A042601-01	Cabinet Assembly—consists of
A041606-01	Pedestal Assembly
A041607-01	Head Assembly
A042602-01	Body Assembly
Ireland-Built Cabinet	
A042601-02	Cabinet Assembly—consists of
A041606-01	Pedestal Assembly
A041607-01	Head Assembly
A042602-01	Body Assembly
US- and Ireland-Built Cabinets	
A038074-07	Switching Power Supply (see service manual TM-261)
A040586-01	Strain-Relief Power Cord
A040587-01	Power On/Off Switch, Harness, and Mounting Plate Assembly
A034630-01	RFI Filter Assembly
A042606-01	Rear Access Panel Assembly for Pedestal—consists of
A038881-01	Lock (Acceptable substitute is part no. A038881-03)
041635-02	Rear Access Panel
037332-01	Ventilation Grille
A042625-01	Main Harness
A042627-01	Power Harness
78-3201	Adjustable Glide
78-6900402	Vinyl Foam Single-Coated Adhesive Tape ¼-Inch Wide x ⅛-Inch Thick (36 inches required; used along top and bottom edge of display shield—not shown)
<i>The following seven items are technical information supplements to this game:</i>	
TM-251	I, ROBOT Operators Manual with Illustrated Parts Lists
SP-251	I, ROBOT Schematic Package
ST-251	I, ROBOT Label with Self-Test Procedure and Option Switch Settings
TM-160	Service Manual for 19-Inch Electrohome Display (Display not shown—use with part no. 92-049)
TM-210	Service Manual for 19-Inch Disco Display (Display shown in illustration—use with part no. 139003-106)
TM-220	Service Manual for 19-Inch Matsushita Display (Display not shown—use with part no. 139003-1004)
TM-261	Switching Power Supply Service Manual
006008-04	Display Shield Extruded Plastic Molding
009992-01	On/Off Switch Cover
034536-09	1-Inch Thick Foam Pad (located between the Power Supply PCB and the cabinet wall)
036130-01	Lower Speaker Grille
038091-01	Molded Coin Box
038870-01	Coin Box Enclosure (not shown)
041130-01	Left Speaker Grille (metal extrusion)
041130-02	Right Speaker Grille (metal extrusion)
041240-01	Rear Access Panel for Head Assembly
041250-01	Display Shield Lower Retainer
041255-01	Attraction Panel
041259-01	Semi-Rigid Attraction Film with Graphics (not shown)

(continued on next page)

Cabinet-Mounted Assemblies Parts List, continued

Part No.	Description
041261-01	Video Display Bezel
041630-02	Rear Access Panel for Body Assembly (includes lock)
041647-01	Display Shield
041649-01	Left Corner Extrusion
041649-02	Right Corner Extrusion
042608-01	Cover Plate
148004-002	5-Inch, 4-Ohm, 6-Ounce Shielded High-Fidelity Speaker (located below control panel)
171063-001	110 V, 60 Hz Exhaust Fan
178013-001	Spring-Draw Latch (not shown)
178034-024	¾-Inch Black Plastic T-Molding (21 inches required on front of pedestal base; 168 inches required on the side panels of the head assembly; 104 inches required on the side panels of the body assembly; 94 inches required on the front panel of the body assembly)
178093-001	Guard for Fan Blade
179125-001	Grounding Clip on Main Harness (not shown)

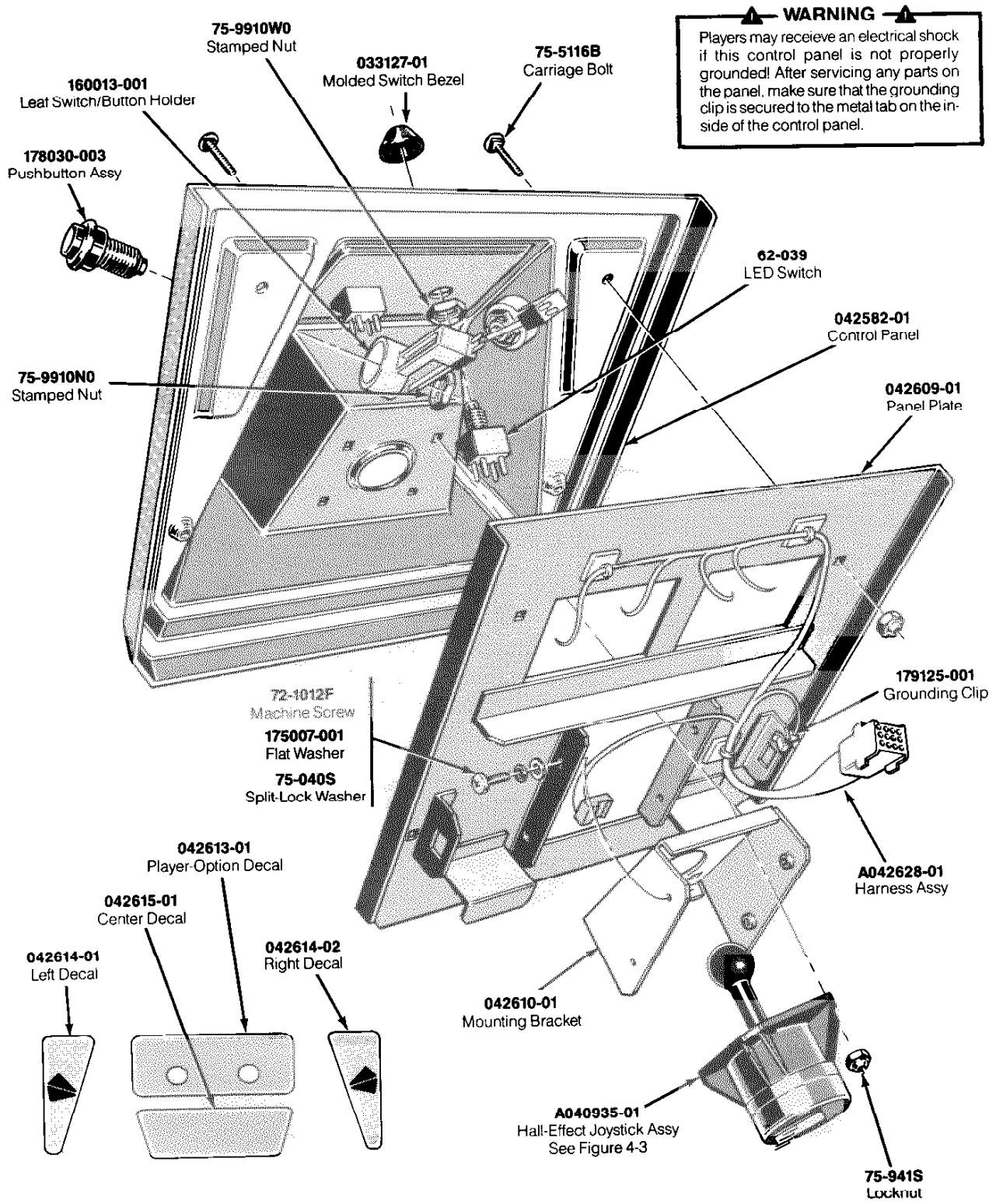
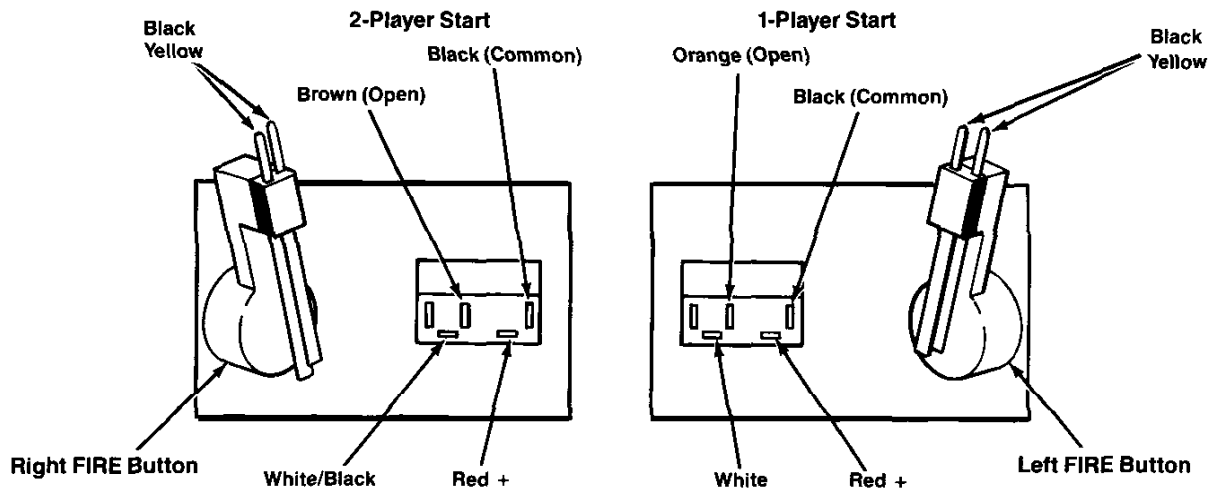

Figure 4-2 Control Panel Assembly
A042603-01 A

**NOTE**

The orientation of the 1- and 2-player start switches may vary.

Figure 4-2 Control Panel Assembly, continued
Parts List

Part No.	Description
A040935-01	Hall-Effect Joystick Assembly
A042628-01	Control Harness Assembly
033127-01	Black Molded Switch Bezel
042582-01	Formed Control Panel
042609-01	Formed Panel Plate
042610-01	Adjustable Mounting Bracket
042613-01	Player-Option Decal
042614-01	Left Decal
042614-02	Right Decal
042615-01	Center Decal
160013-001	Leaf Switch with Button Holder
178030-003	Black Pushbutton Assembly
179125-001	Grounding Clip
62-039	SPDT Momentary Pushbutton Start Switch with Red LED
72-1012F	#10-32 × ¾-Inch Cross-Recessed Machine Screw
75-010S	#10 Flat Washer
75-040S	#10 Split-Lock Washer
75-941S	#10-24 Hex Locknut
75-5112B	#10-24 × ¾-Inch Black Carriage Bolt
75-9910N0	⅝-Inch × 11 Stamped Nut
75-9910W0	1½ ₂ -32 Stamped Nut

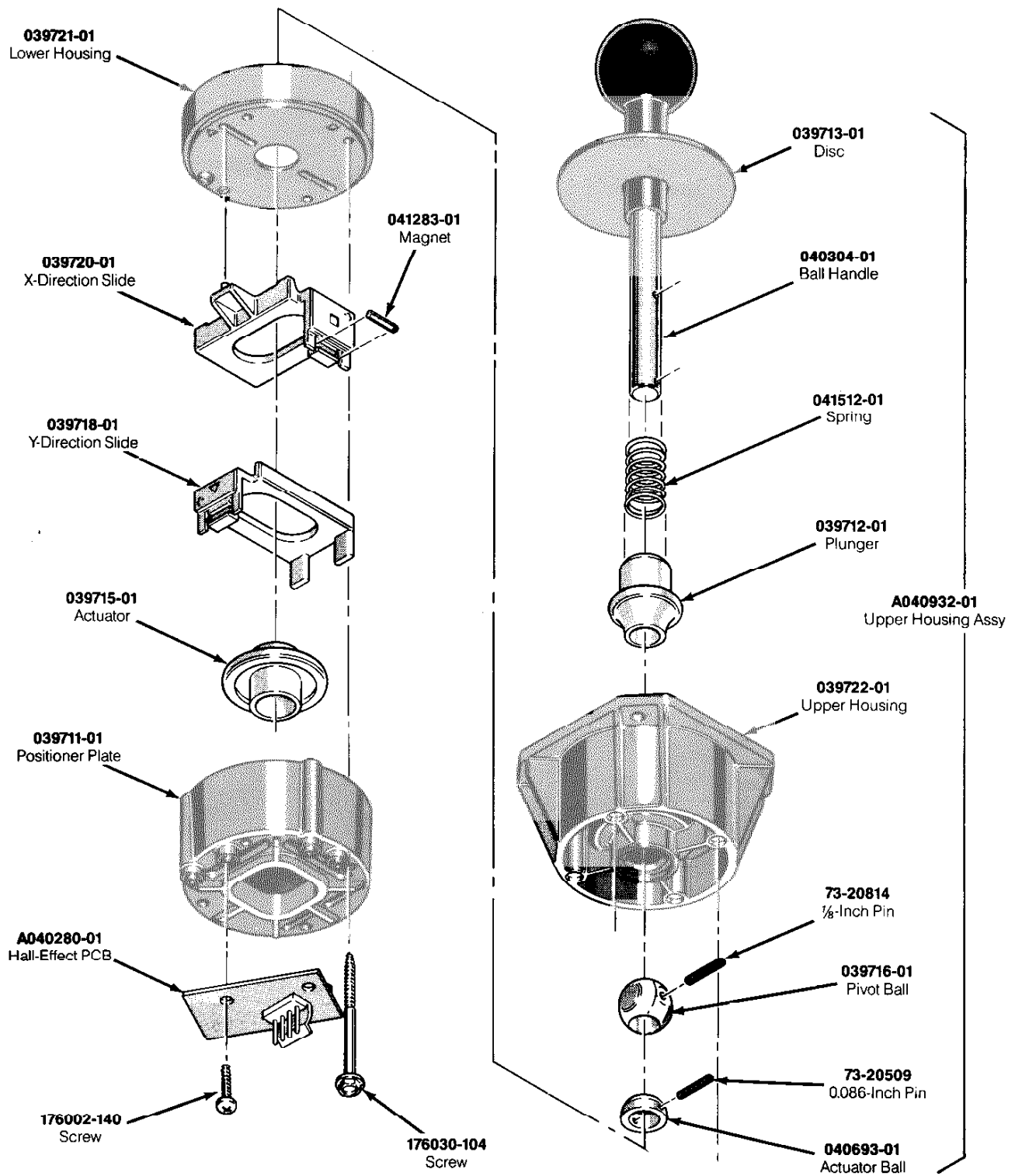

**Figure 4-3 Hall-Effect Joystick Assembly
A040935-01 A**

Hall-Effect Joystick Assembly Parts List

Part No.	Description
A040341-01	Hall-Effect Printed-Circuit Board
A040932-01	Upper Housing Joystick Assembly—includes
039712-01	Plunger
039713-01	Disc
039716-01	Pivot Ball
039722-01	Upper Housing
040304-01	Joystick Ball Handle
040693-01	Actuator Ball
040705-01	Compression Plunger Spring
73-20509	0.086 × $\frac{7}{64}$ -Inch Roll Pin
73-20814	$\frac{1}{8}$ × $\frac{7}{8}$ -Inch Roll Pin
039711-xx	Positioner Hall-Effect Plate
039715-01	Actuator
039718-01	Y-Direction Slide
039720-01	X-Direction Slide
039721-01	Lower Microswitch Housing
041283-01	0.125 × 0.625 Magnet
176002-140	#8-16 × 2 $\frac{3}{4}$ -Inch Hex Head Self-Tapping Screw
176030-140	#4-20 × $\frac{3}{4}$ -Inch Pan Head Self-Tapping Screw

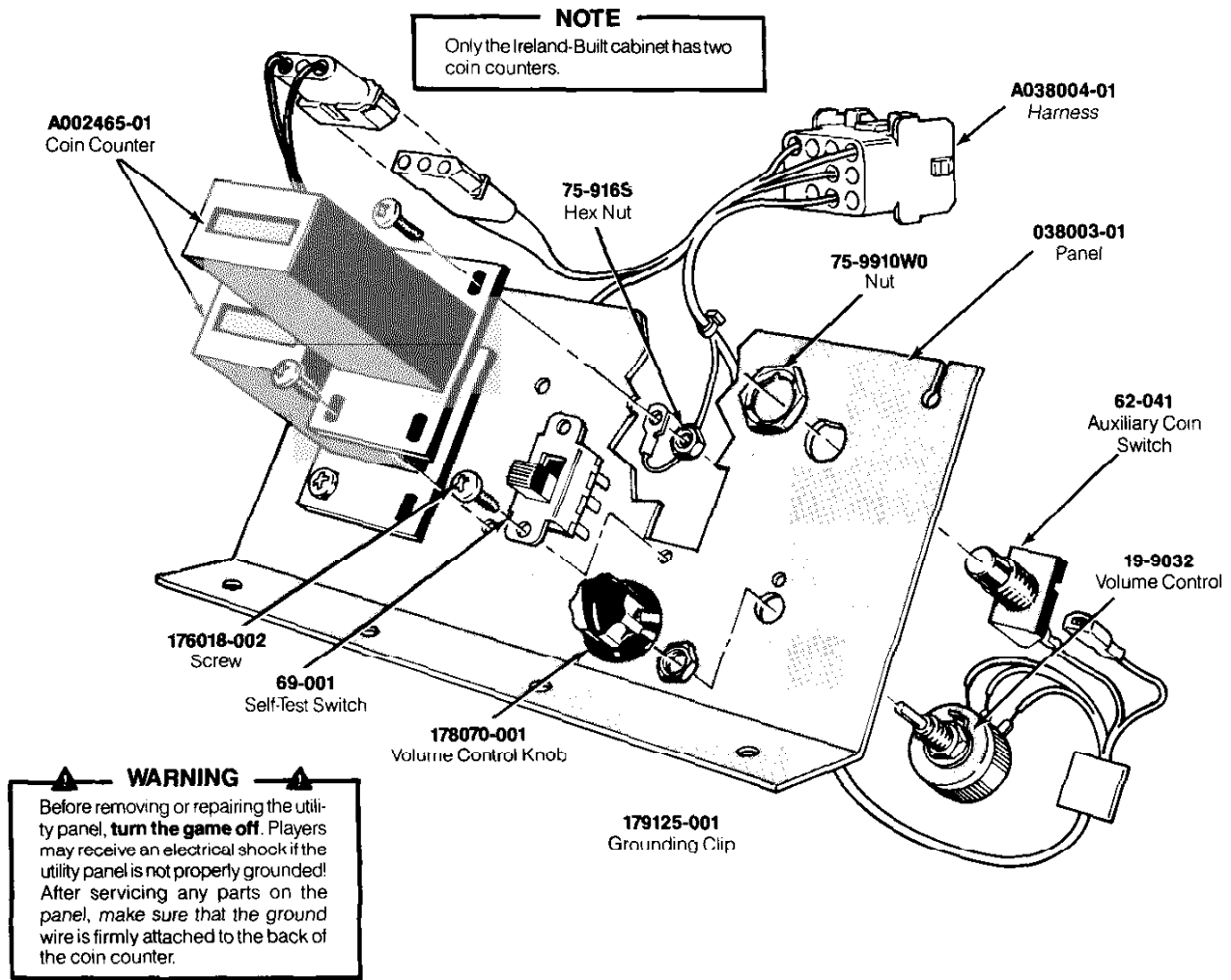

**Figure 4-4 Utility Panel Assembly
A038002-01 H
Parts List**

Part No.	Description
A002465-01	6 V Coin Counter
A038004-01	Utility Panel Harness
19-9032	Volume Control
62-041	SPDT Momentary-Contact Pushbutton Auxiliary Coin Switch with Black Cap
69-001	DPTDT Self-Test Switch
75-916S	#6-32 Hexagon Machine Nut
75-9910W0	¹⁵ / ₃₂ -32 Stamped Nut
038003-01	Utility Panel
176018-002	#6-32 × 1/2-Inch Thread Forming Pan-Head Screw
178070-001	Volume Control Knob
179125-001	Grounding Clip

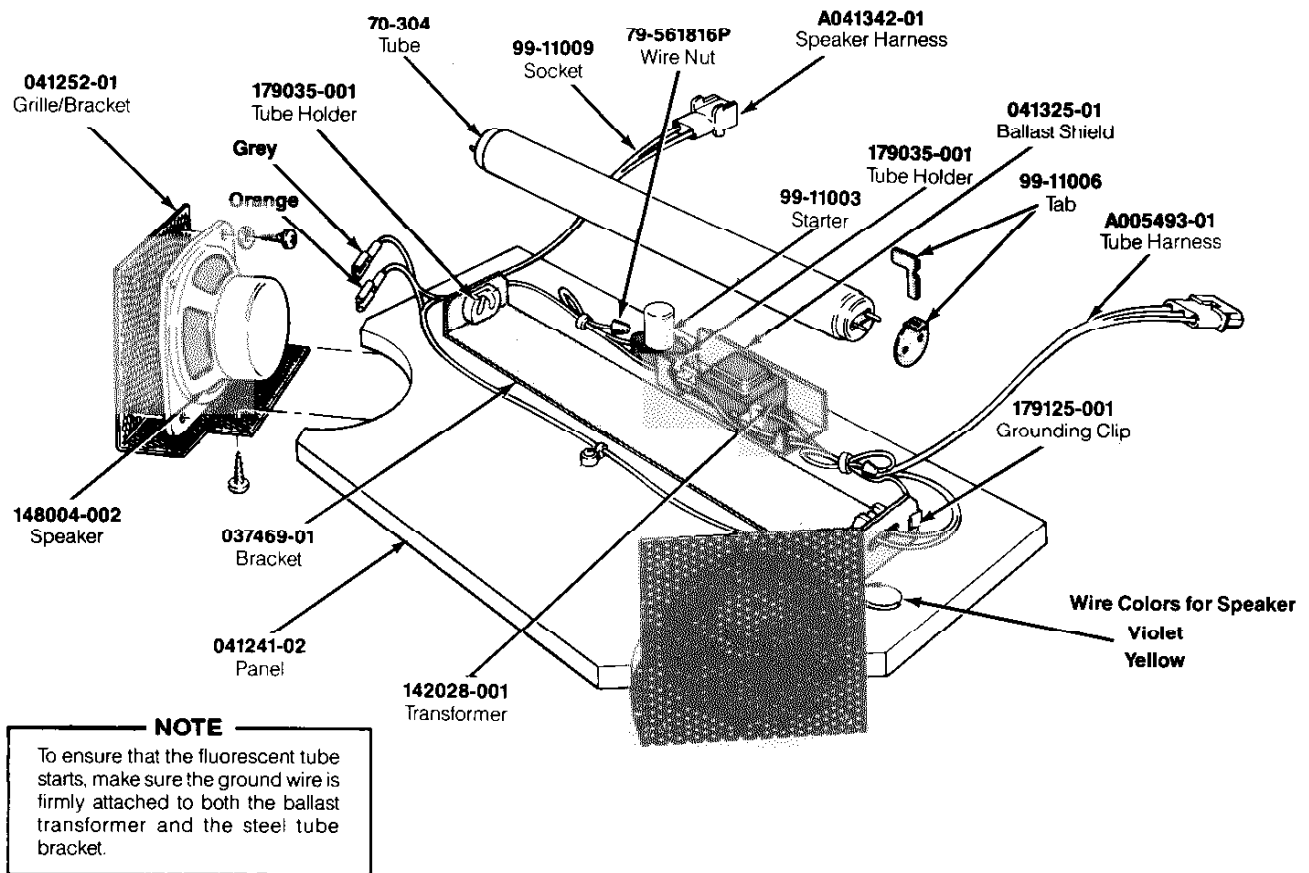

Figure 4-5 Fluorescent Tube and Speaker Assembly
A041320-01 A
Parts List

Part No.	Description
A005493-01	Fluorescent Tube Harness Assembly
A037540-01	Ground Wire with Grounding Clip
A041342-01	Speaker Harness Assembly
70-304	18-Inch, 15-Watt, Cool White Fluorescent Tube
79-561816P	Spring-Connector Wire Nut for 16- to 18-Gauge Wires
99-11003	Fluorescent Tube Starter
99-11006	Fluorescent Tube Locking Tab (consists of two pieces)
99-11009	Starter Socket
037469-01	Steel Tube Bracket
041241-02	Wood Mounting Panel
041252-01	Speaker Mounting Grille/Bracket
041325-01	Ballast Shield
142028-001	60 Hz, 118 V, Ballast Transformer
148004-002	5-Inch Diameter, 5 W, 4 Ohm, Shielded Speaker
179035-001	2-Pin Fluorescent Tube Holder
179125-001	Grounding Clip (Acceptable substitute is part no. 179174-010)

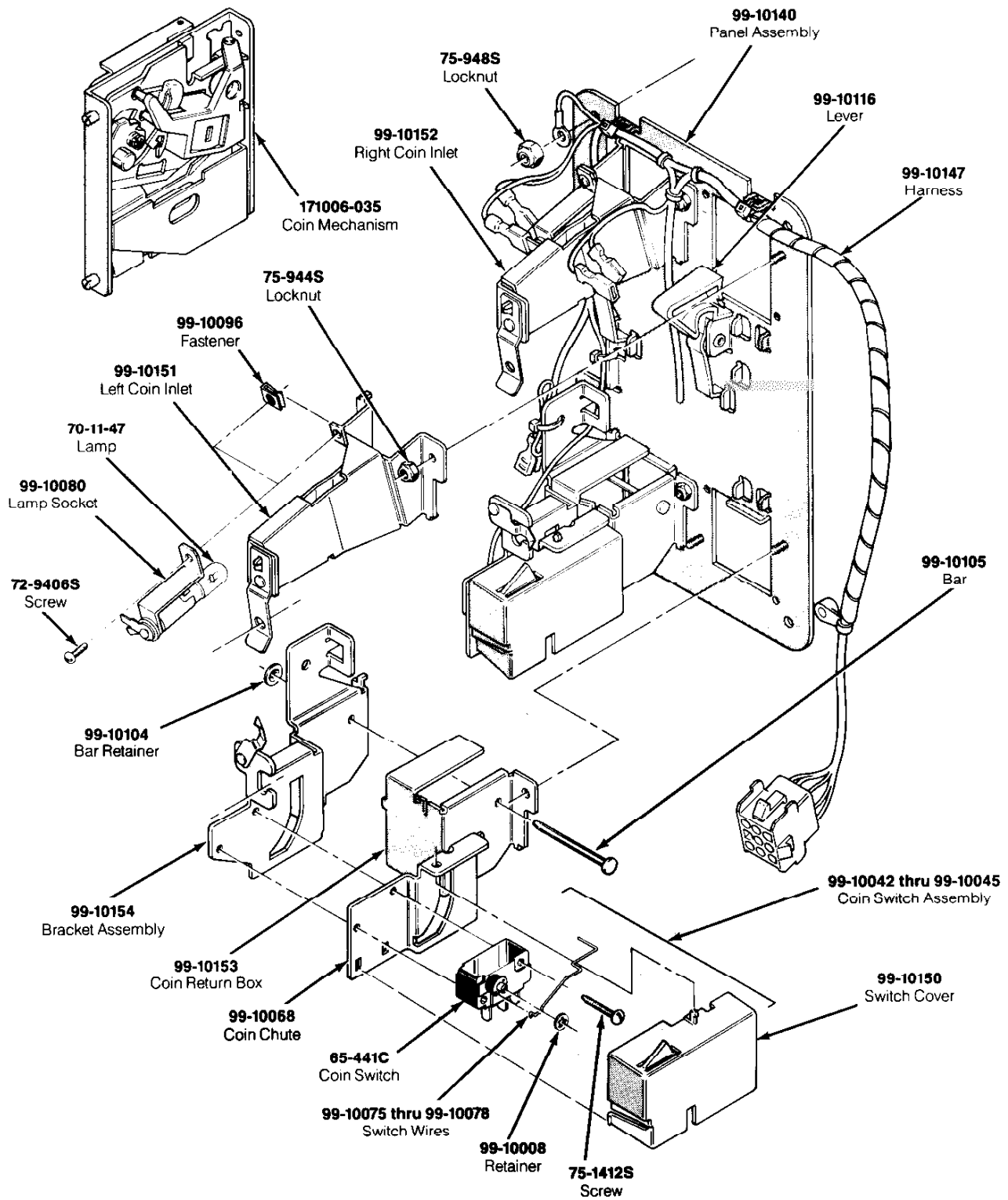

Figure 4-6 Coin Controls, Inc. Coin Door Assembly
171034-xxx A

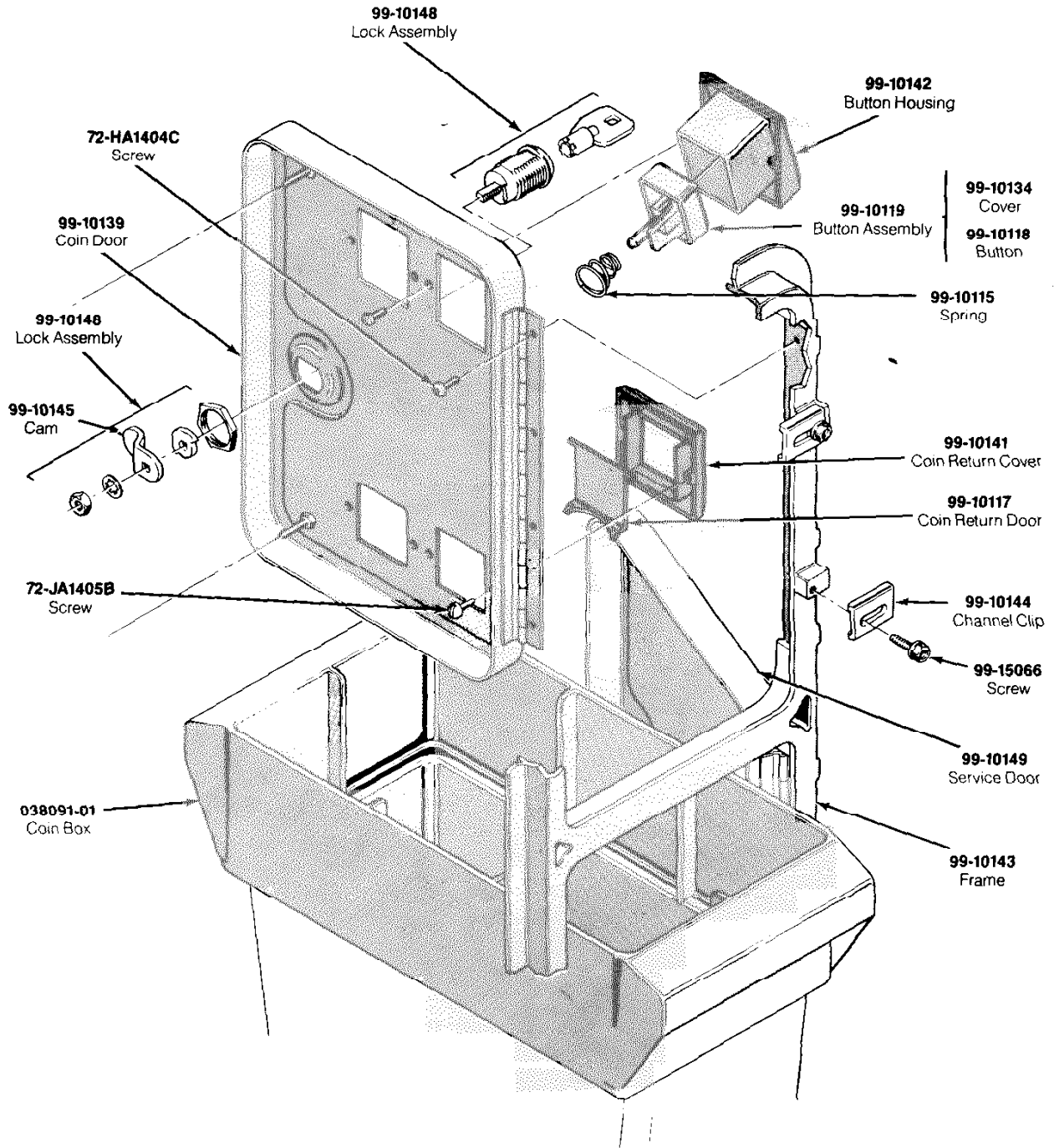
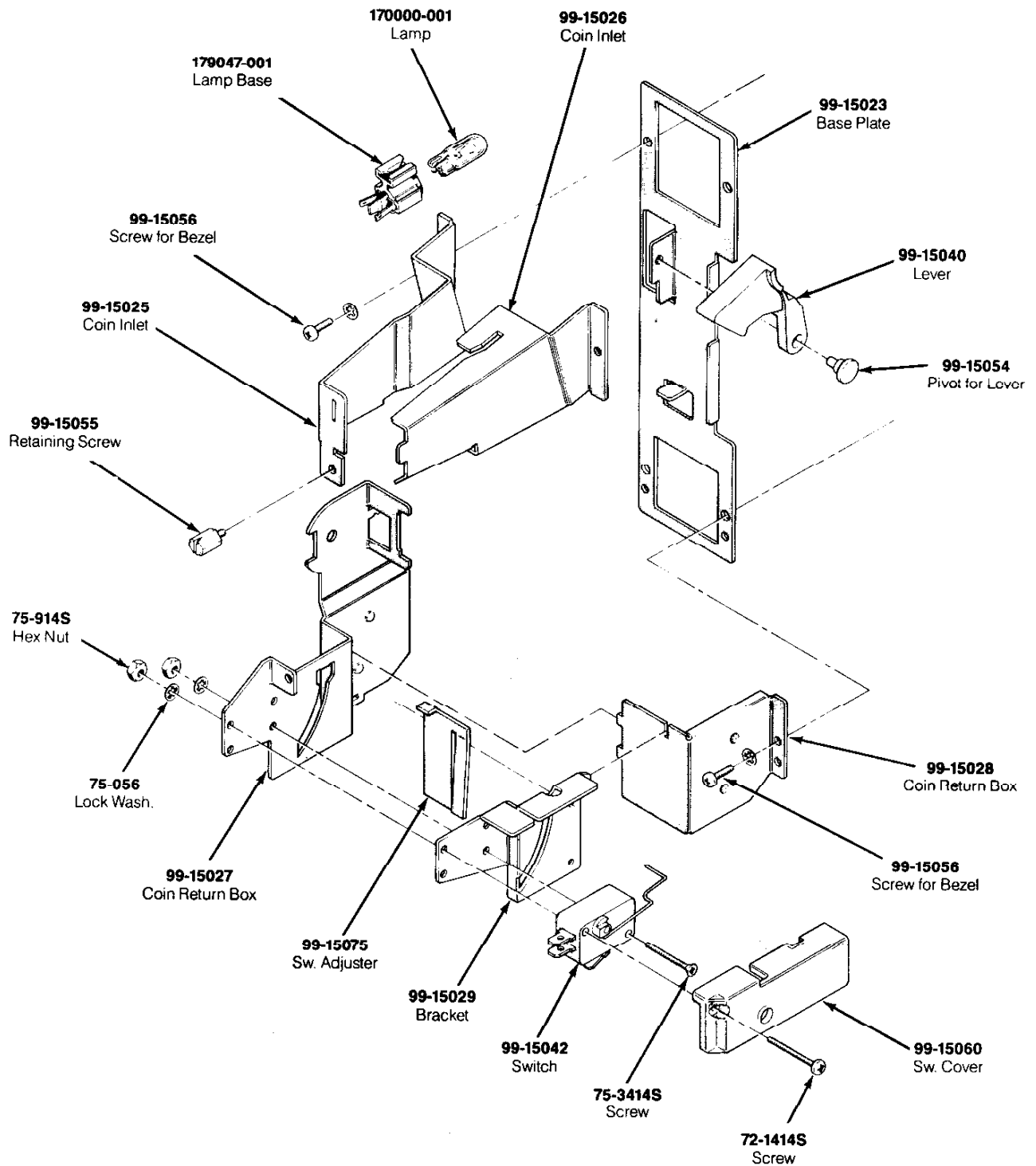

Figure 4-6 Coin Controls, Inc. Coin Door Assembly, continued
171034-xxx A

Coin Controls, Inc. Coin Door Assembly Parts List

Part No.	Description
A036597-01	Harness Assembly (Ireland-built cabinet only)
A037542-01	Harness Assembly
72-1414S	#4-40 × 7/8-Inch Cross-Recessed Pan Head Steel Machine Screw
75-056	#6 Internal-Tooth Zinc-Plated Steel Lock Washer
75-914S	#4-40 Steel Machine Hex Nut
75-3414S	#4-40 × 7/8-Inch 82° Cross-Recessed Flat-Head Steel Machine Screw
99-15001	Coin Return Button with U.S. 25-Cent Price Plate
99-15002	Coin Return Button with U.S. \$1 Price Plate
99-15003	Coin Return Button with German 1 DM Price Plate
99-15004	Coin Return Button with German 2 DM Price Plate
99-15005	Coin Return Button with German 5 DM Price Plate
99-15006	Coin Return Button with Belgian 5 Fr Price Plate
99-15007	Coin Return Button with French 1 Fr Price Plate
99-15008	Coin Return Button with Japanese 100 Yen Price Plate
99-15009	Coin Return Button with British 10 Pence Price Plate
99-15010	Coin Return Button with Australian 20-Cent Price Plate
99-15011	Coin Return Button with Italian 100 Lire Price Plate
99-15025	Left Half of Coin Inlet
99-15026	Right Half of Coin Inlet
99-15027	Side Plate of Coin Return Box
99-15028	Base Plate of Coin Return Box
99-15029	Switch Bracket
99-15036	Metal Coin Return Cover
99-15038	Bezel for Coin Return Button
99-15039	Metal Bezel for Coin Return Button
99-15042	Coin Switch for U.S. 25 Cents
99-15052	Spring for Coin Return Button
99-15055	Retaining Screw
99-15056	#4-40 × 7/8-Inch Cross-Recessed Pan-Head Steel Machine Screw
99-15060	Switch Cover
99-15063	Screw for Hinge
99-15066	Screw for Clamp
99-15067	Lock Assembly
99-15070	Doors and Frame
99-15071	Clamp for Frame
99-15072	Door Frame
99-15073	Upper Door
99-15074	Lower Door
99-15075	Switch Adjuster
99-15083	Base Plate—includes:
99-15040	Lever
99-15054	Pivot for Lever
038091-01	Coin Box—not included in assembly (Acceptable substitute is part no. A037491-01)
170000-001	6.3 V Miniature Wedge-Base Incandescent Lamp
171006-035	Metal Coin Mechanism
171050-001	Dual Entry Face Plate
179047-001	Lamp Base



**Figure 4-7 Coin Acceptors, Inc. Coin Door Assembly
171027-001 A**

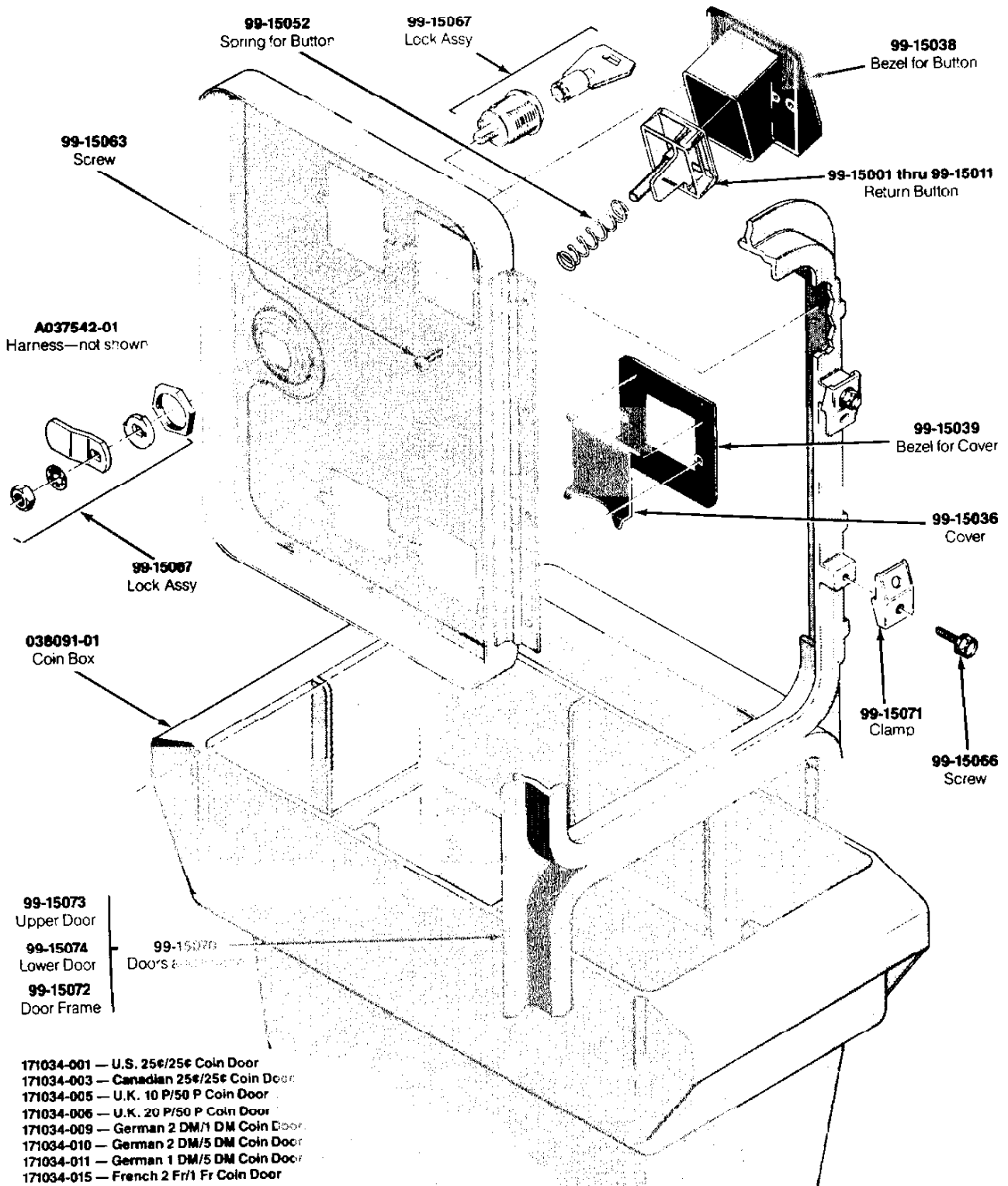

Figure 4-7 Coin Acceptors, Inc. Coin Door Assembly, continued
 171027-001 A

Coin Acceptors, Inc. Coin Door Assembly Parts List

Part No.	Description
65-441C	Coin Switch
70-11-47	Miniature Bayonet Lamp
72-9406S	#4-40 × 3/8-Inch Truss-Head Screw
72-HA1404C	#4-40 × 1/4-Inch Pan-Head Screw
72-JA1405B	#4-40 × .31-Inch Pan-Head Screw
75-1412S	#4-40 × 3/4-Inch Pan-Head Screw
75-944S	#4-40 Locknut
99-10008	Retainer
99-10042	Coin Switch Assembly for Belgian 5 Fr and U.S. \$.25
99-10043	Coin Switch Assembly for German 1 DM, Japanese 100 Yen, Swiss 1 Fr
99-10044	Coin Switch Assembly for German 2 DM, Italian 100 L, U.S. \$1.00
99-10045	Coin Switch Assembly for Australian \$.20, German 5 DM, British 10 P
99-10068	Coin Return Chute
99-10075	Switch Wire (included in coin switch assembly 99-10043)
99-10076	Switch Wire (included in coin switch assembly 99-10042)
99-10077	Switch Wire (included in coin switch assembly 99-10044)
99-10078	Switch Wire (included in coin switch assembly 99-10045)
99-10080	Lamp Socket
99-10081	Key Holder
99-10096	Fastener
99-10104	Bar Retainer
99-10105	Bar
99-10115	Spring
99-10116	Plastic Coin Return Lever
99-10117	Steel Coin Return Door
99-10118	Amber Coin Return Button
99-10119	Amber Coin Button for U.S. \$.25
99-10134	Coin Button Cover
99-10139	Coin Door
99-10140	Coin Door Inner-Panel Assembly
99-10141	Die-Cast Coin Return Cover
99-10142	Die-Cast Button Housing
99-10143	Coin Door Frame
99-10144	Channel Clip
99-10145	Cam
99-10147	Harness
99-10148	Lock Assembly
99-10149	Service Door
99-10150	Switch Cover
99-10151	Left Coin Inlet
99-10152	Right Coin Inlet
99-10153	Coin Return Box
99-10154	Bracket Assembly
99-15066	Screw for Clamp
038091-01	Coin Box
171006-035	Metal Coin Mechanism for U.S. \$.25
177010-238	#8-32 Hex Locknut

NOTE
 For US-built games the FCC requires that the game printed-circuit boards be housed in the EMI cage with the EMI Shield PCB attached.

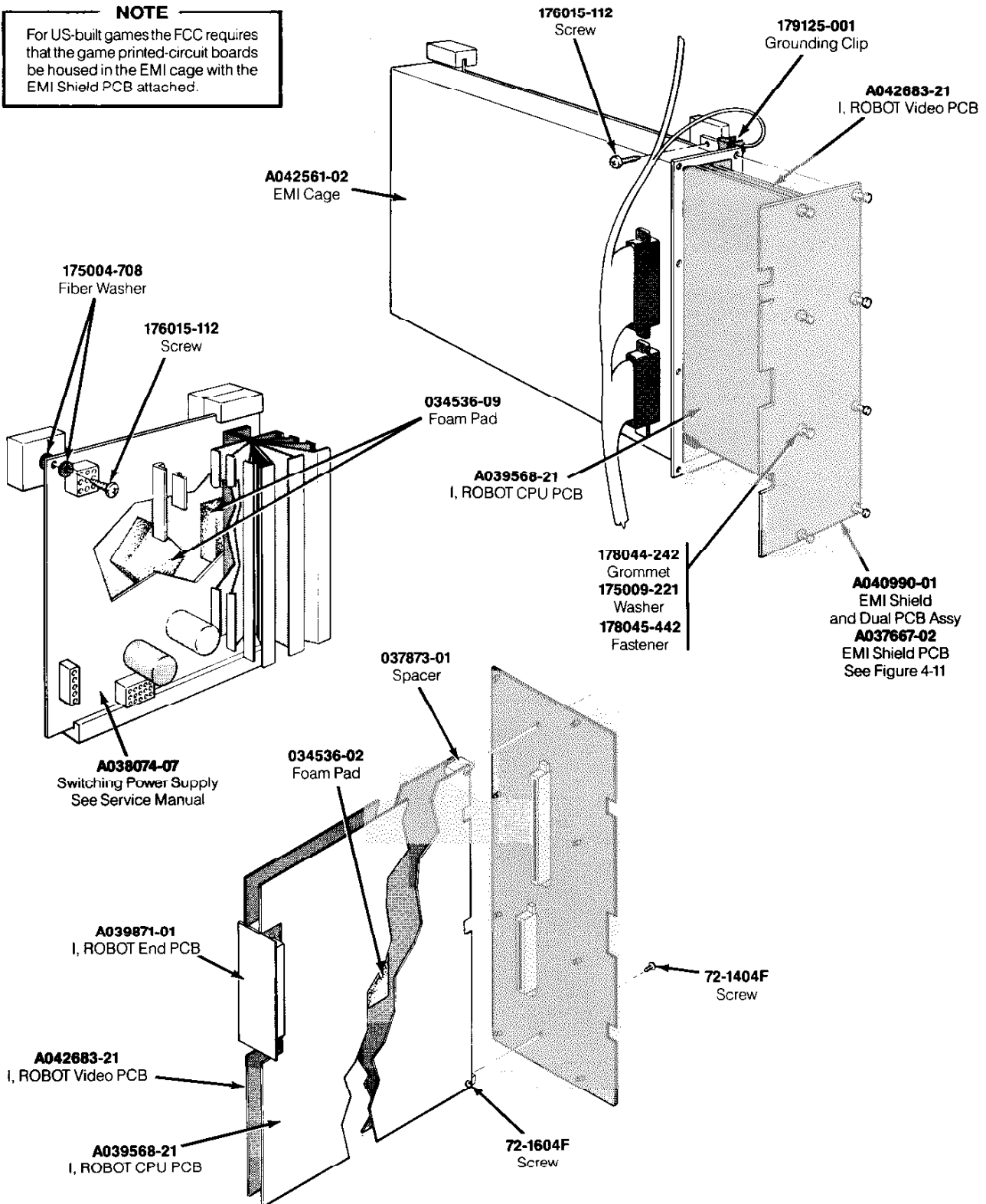

Figure 4-8 Printed-Circuit Board Mounting Hardware (US & Ireland)

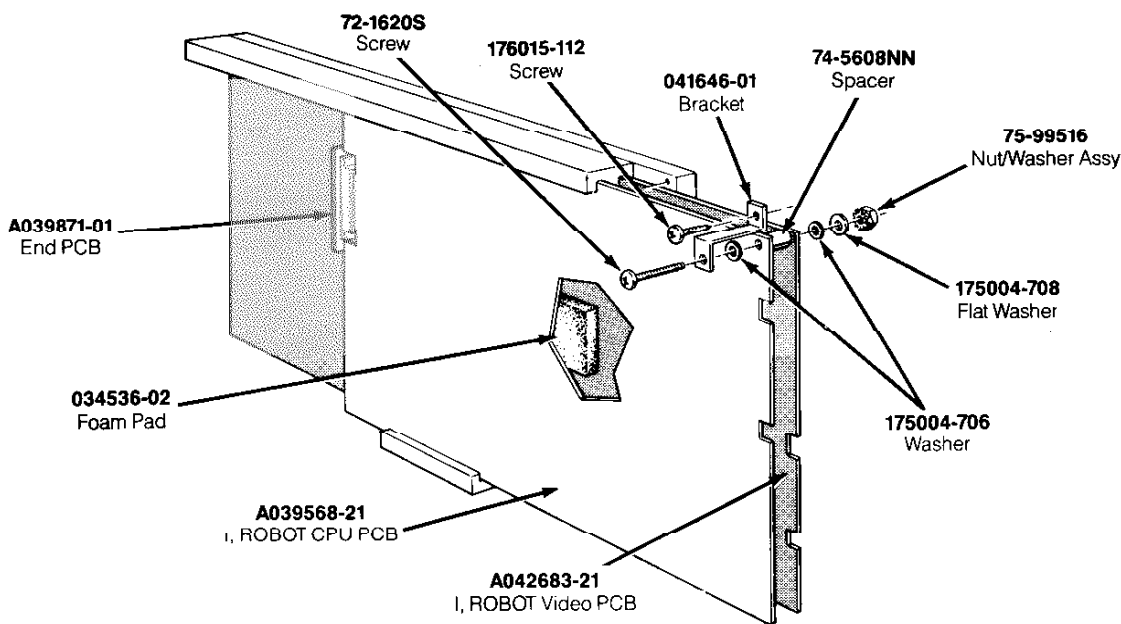

Figure 4-8 Printed-Circuit Board Mounting Hardware (Ireland), continued

Parts List

Part No.	Description
US-Built Games	
A042561-02	EMI Cage Assembly
A040990-01	EMI Shield and Dual Printed-Circuit Board Assembly
A037667-02	EMI Shield Printed-Circuit Board Assembly
179125-001	Grounding Clip
178045-442	Snap-In Fastener
178044-242	Grommet
175009-221	Plastic Washer
037873-01	Printed-Circuit Board Spacer
72-1604F	#6-32 x 1/4-Inch Cross-Recessed Steel Screw
72-1404F	#4-40 x 1/4-Inch Cross-Recessed Steel Screw
Ireland-Built Games	
175004-706	#6 Fiber Washer
74-5608NN	#6 x 1/2-Inch Spacer
75-99516	#6-32 Nut/Washer Assembly
72-1620S	#6-32 x 1 1/4-Inch Cross-Recessed Pan-Head Steel Screw
041646-01	Printed-Circuit Board Mounting Bracket
034536-02	1/2-Inch Foam Pad
US- and Ireland-Built Games	
A042683-21	I, ROBOT Video Printed-Circuit Board
A039568-21	I, ROBOT CPU Printed-Circuit Board
A039871-01	I, ROBOT End Printed-Circuit Board
A038074-07	Switching Power Supply
176015-112	#10 x 3/8-Inch Cross-Recessed Pan-Head Screw
175004-708	#8 Flat Fiber Washer
034536-09	1-Inch Foam Pad

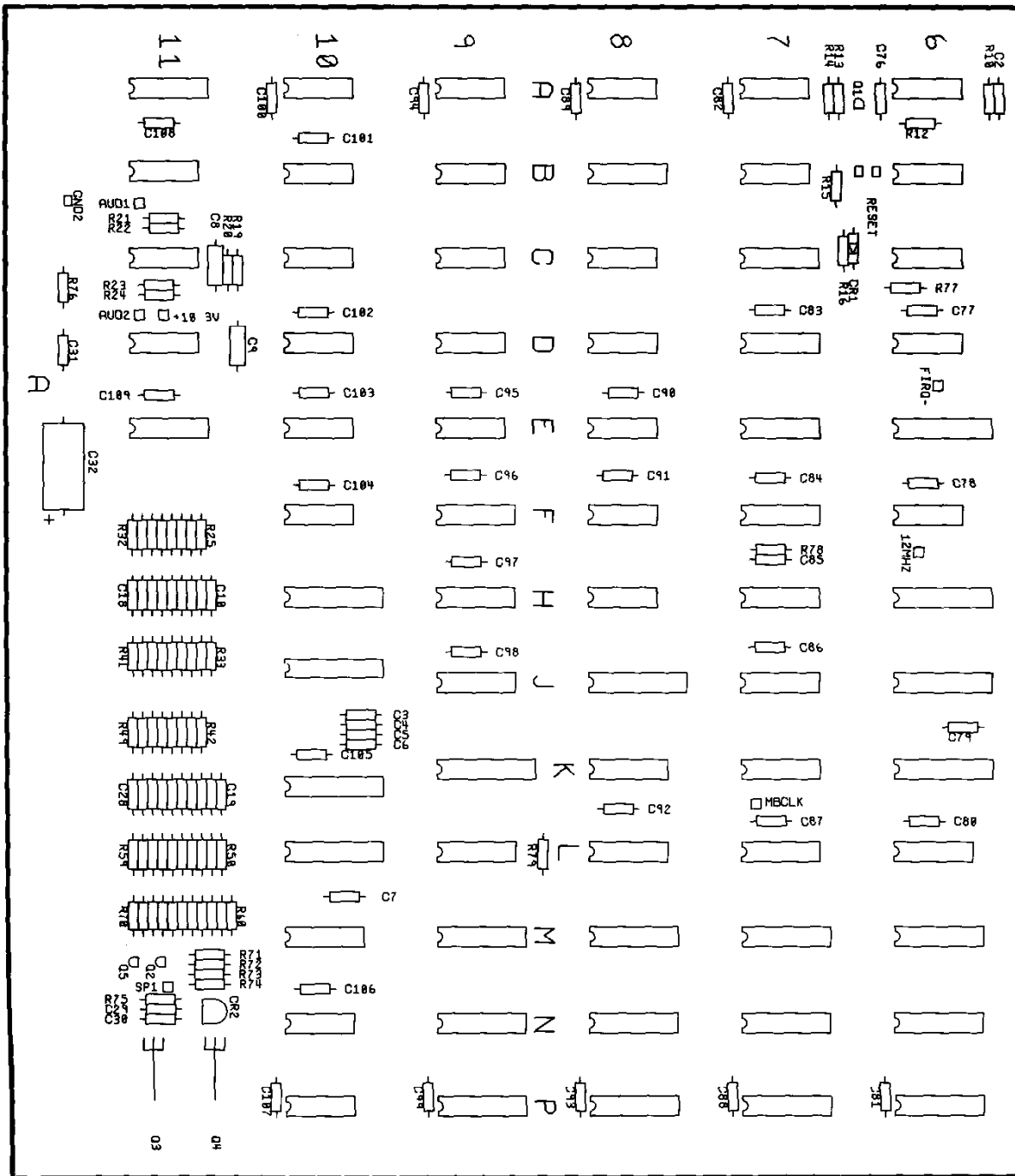

Figure 4-9 I, ROBOT CPU PCB Assembly
A039568-21 A

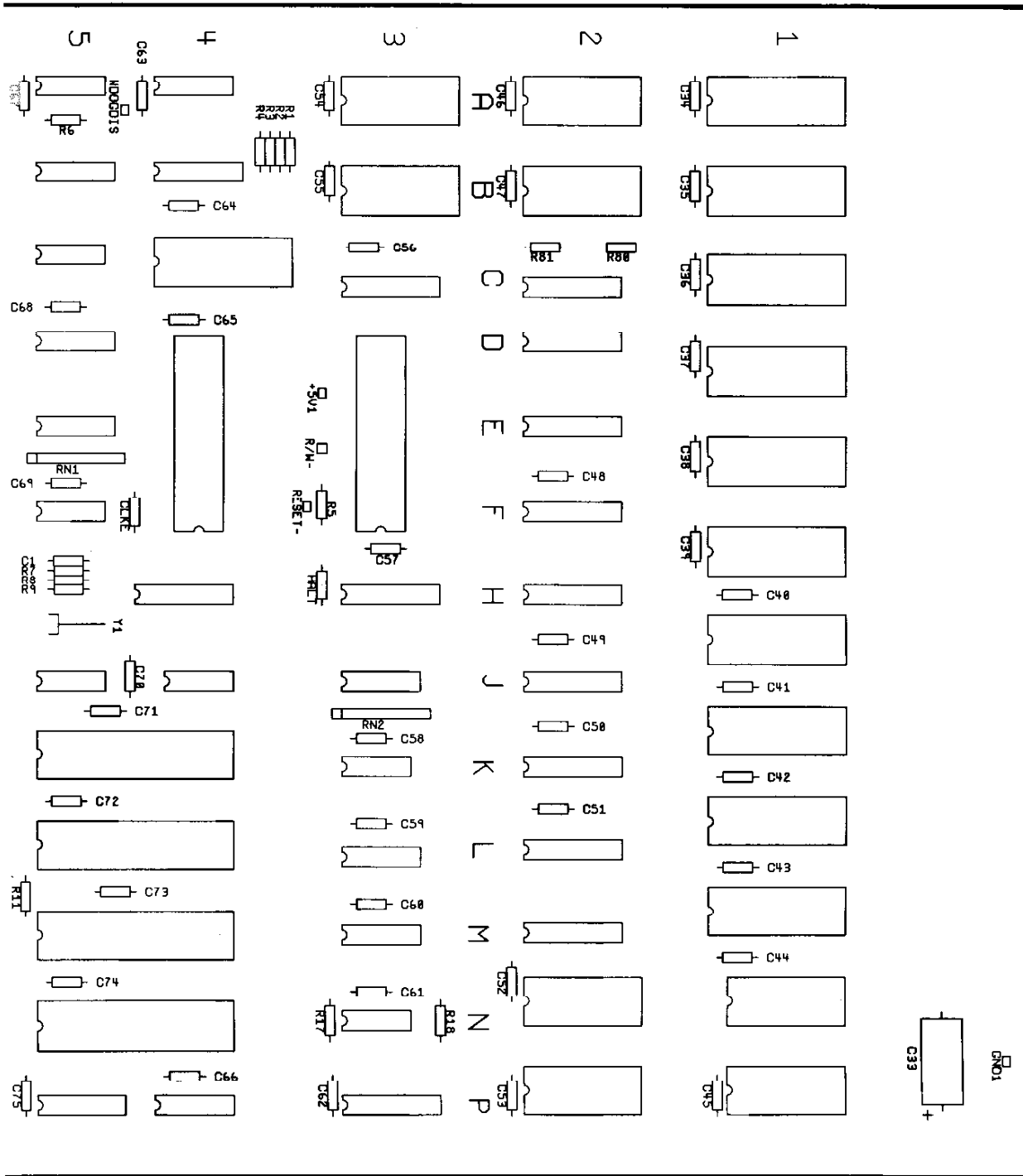

Figure 4-9 I, ROBOT CPU PCB Assembly, continued
A039568-21 A

I, ROBOT CPU PCB Assembly Parts List

Designator	Description	Part No.
Capacitors		
C1	0.1 μ F, 25 V, Ceramic Capacitor	122006-104
C2	0.01 μ F, 25 V, Ceramic Capacitor	122005-103
C3-C7	0.1 μ F, 25 V, Ceramic Capacitor	122006-104
C8, C9	0.22 μ F, 25 V, Ceramic Capacitor	122006-224
C10-C30	0.1 μ F, 25 V, Ceramic Capacitor	122006-104
C31	0.47 μ F, 50 V, Electrolytic Capacitor	122006-224
C32, C33	100 μ F, 50 V, Electrolytic Capacitor	124001-107
C34-C109	0.1 μ F, 25 V, Ceramic Capacitor	122006-104
Diodes		
CR1	Type-1N758 Diode	32-1N758
CR2	Type-MV5053 Diode	38-MV5053
Electronically Programmable Read-Only Memories		
1A	Type-27128-4 EPROM Integrated Circuit	136029-105
1B	Type-27128-4 EPROM Integrated Circuit	136029-106
1C/D	Type-27128-4 EPROM Integrated Circuit	136029-107
1D/E	Type-2764-4 EPROM Integrated Circuit	136029-108
1E/F	Type-27128-4 EPROM Integrated Circuit	136029-109
1F/H	Type-27128-4 EPROM Integrated Circuit	136029-110
1J/K	Type-2764-2 EPROM Integrated Circuit	136029-103
1K/L	Type-2764-2 EPROM Integrated Circuit	136029-104
Integrated Circuits		
2C/D	Type-74LS273 Integrated Circuit	37-74LS273
2D-2F	Type-74LS244 Integrated Circuit	37-74LS244
2H	Type-74LS245 Integrated Circuit	37-74LS245
2J	Type-74LS244 Integrated Circuit	37-74LS244
2K, 2L	Type-74LS245 Integrated Circuit	37-74LS245
2M	Type-74LS374 Integrated Circuit	37-74LS374
3C/D	Type-74LS245 Integrated Circuit	37-74LS245
3E	68B09E Microprocessor Integrated Circuit	137249-120
3H	Type-74LS244 Integrated Circuit	37-74LS244
3K	Type-74S32 Integrated Circuit	37-74S32
3L, 3M	Type-74S253 Integrated Circuit	137248-001
3N	Type-74S08 Integrated Circuit	37-74S08
3P	Type-74LS244 Integrated Circuit	37-74LS244
4A	Type-74LS139 Integrated Circuit	37-74LS139
4B	X2212 Integrated Circuit	137288-01
4C	ADC0809 Integrated Circuit	137243-001
4E	Custom Integrated Circuit	137324-1221
4H	Type-74LS244 Integrated Circuit	37-74LS244
4J	Type-74LS04 Integrated Circuit	37-74LS04
4/5K	2901-C Transistor Array Integrated Circuit	137340-001

(continued on next page)

I, ROBOT CPU PCB Assembly Parts List, continued

Designator	Description	Part No.
4/5L	2901-C Transistor Array Integrated Circuit	137340-001
4/5M	2901-C Transistor Array Integrated Circuit	137340-001
4/5N	2901-C Transistor Array Integrated Circuit	137340-001
4P	Type-74S182 Integrated Circuit	37-74S182
5A	Type-74LS00 Integrated Circuit	37-74LS00
5B	Type-74LS139 Integrated Circuit	37-74LS139
5C	Type-74LS74 Integrated Circuit	37-74LS74
5D	Type-74LS139 Integrated Circuit	37-74LS139
5J	Type-74S32 Integrated Circuit	37-74S32
5F	Type-74S04 Integrated Circuit	37-74S04
6A	Type-74LS14 Integrated Circuit	37-74LS14
6B	Type-74LS04 Integrated Circuit	37-74LS04
6C	Type-74LS11 Integrated Circuit	137016-001
6D	Type-74LS74 Integrated Circuit	37-74LS74
6E	Type-74LS244 Integrated Circuit	37-74LS244
6F	Type-74S74 Integrated Circuit	37-74S74
6J, 6K	Type-74LS245 Integrated Circuit	37-74LS245
6H	Type-74LS273 Integrated Circuit	37-74LS273
6L	Type-74S163 Integrated Circuit	37-74S163
7A	Type-74LS90 Integrated Circuit	37-74LS90
7B	Type-74LS32 Integrated Circuit	37-74LS32
7C, 7D	Type-74LS139 Integrated Circuit	37-74LS139
7E	Type-74LS163A Integrated Circuit	37-74LS163A
7F	Type-74S189 Integrated Circuit	37-74S189
7H, 7J	Type-74S189 Integrated Circuit	37-74S189
7K	Type-74LS163A Integrated Circuit	37-74LS163A
7L	Type-74S163 Integrated Circuit	37-74S163
8A	Type-74S32 Integrated Circuit	37-74S32
8B	Type-74LS139 Integrated Circuit	37-74LS139
8C	Type-74LS32 Integrated Circuit	37-74LS32
8D	Type-74LS08 Integrated Circuit	37-74LS08
8E	Type-74S32 Integrated Circuit	37-74S32
8F	Type-74S04 Integrated Circuit	37-74S04
8H	Type-74LS125 Integrated Circuit	37-74LS125
8J	Type-74LS240 Integrated Circuit	137251-001
8K	Type-74LS83 Integrated Circuit	37-74LS83
8L	Type-74S163 Integrated Circuit	37-74S163
9A	Type-74S74 Integrated Circuit	37-74S74
9B	Type-74LS00 Integrated Circuit	37-74LS00
9C	Type-74LS04 Integrated Circuit	37-74LS04
9D	Type-74LS32 Integrated Circuit	37-74LS32
9E	Type-74S08 Integrated Circuit	37-74S08
9F	Type-74S163 Integrated Circuit	37-74S163
9H, 9J	Type-74LS83 Integrated Circuit	37-74LS83

(continued on next page)

I, ROBOT CPU PCB Assembly Parts List, continued

Designator	Description	Part No.
9K	Type-74LS273 Integrated Circuit	37-74LS273
9L	Type-74LS174 Integrated Circuit	37-74LS174
10A	Type-74LS86 Integrated Circuit	37-74LS86
10B	Type-74S32 Integrated Circuit	37-74S32
10C	Type-74LS08 Integrated Circuit	37-74LS08
10D	Type-74S32 Integrated Circuit	37-74S32
10E	Type-74LS125 Integrated Circuit	37-74LS125
10F	Type-74S10 Integrated Circuit	37-74S10
10H-10K	Type-74LS244 Integrated Circuit	37-74LS244
10L	Type-74LS273 Integrated Circuit	37-74LS273
10M	Type-74LS151 Integrated Circuit	37-74LS151
10N	Type-74S00 Integrated Circuit	37-74S00
10P	Type-74S04 Integrated Circuit	37-74S04
11B	Type-74LS32 Integrated Circuit	37-74LS32
11C	Type-LM324 Integrated Circuit	37-LM324
11D	Type-74LS10 Integrated Circuit	37-74LS10
11E	Type-74LS83 Integrated Circuit	37-74LS83
Programmable Read-Only Memories (PROM)		
5P	82HS137 PROM Integrated Circuit	136029-112
6M	82HS137 PROM Integrated Circuit	136029-113
6N	82HS137 PROM Integrated Circuit	136029-111
6P	82HS137 PROM Integrated Circuit	136029-116
7M	82HS137 PROM Integrated Circuit	136029-121
7N	82HS137 PROM Integrated Circuit	136029-114
7P	82HS137 PROM Integrated Circuit	136029-123
8M	82HS137 PROM Integrated Circuit	136029-117
8N	82HS137 PROM Integrated Circuit	136029-115
8P	82HS137 PROM Integrated Circuit	136029-119
9M	82HS137 PROM Integrated Circuit	136029-120
9N	82HS137 PROM Integrated Circuit	136029-118
9P	82HS137 PROM Integrated Circuit	136029-122
Random-Access Memories (RAM)		
1N	Type-6116-2 RAM Integrated Circuit	137211-120
1P	Type-6116-2 RAM Integrated Circuit	137211-120
2N	Type-6116-2 RAM Integrated Circuit	137211-120
2P	Type-6116-2 RAM Integrated Circuit	137211-120
2A, 2B	Type-6116 RAM Integrated Circuit	137211-001
3A, 3B	Type-6116 RAM Integrated Circuit	137211-001
Read-Only Memories (ROM)		
1H/J	Type-23128-2 ROM Integrated Circuit	136029-101
1L/M	Type-23128-2 ROM Integrated Circuit	136029-102

(continued on next page)

I, ROBOT CPU PCB Assembly Parts List, continued

Designator	Description	Part No.
Resistors		
R1	330 Ω , $\pm 5\%$, $\frac{1}{4}$ W Resistor	110000-331
R2	220 Ω , $\pm 5\%$, $\frac{1}{4}$ W Resistor	110000-221
R3	330 Ω , $\pm 5\%$, $\frac{1}{4}$ W Resistor	110000-331
R4	220 Ω , $\pm 5\%$, $\frac{1}{4}$ W Resistor	110000-221
R5, R6	1 k Ω , $\pm 5\%$, $\frac{1}{4}$ W Resistor	110000-102
R7	330 Ω , $\pm 5\%$, $\frac{1}{4}$ W Resistor	110000-331
R8	820 Ω , $\pm 5\%$, $\frac{1}{4}$ W Resistor	110000-821
R9	330 Ω , $\pm 5\%$, $\frac{1}{4}$ W Resistor	110000-331
R10	220 Ω , $\pm 5\%$, $\frac{1}{4}$ W Resistor	110000-221
R11	470 Ω , $\pm 5\%$, $\frac{1}{4}$ W Resistor	110000-471
R12	4.7 Ω , $\pm 5\%$, $\frac{1}{4}$ W Resistor	110000-472
R13	220 Ω , $\pm 5\%$, $\frac{1}{4}$ W Resistor	110000-221
R14	330 Ω , $\pm 5\%$, $\frac{1}{4}$ W Resistor	110000-331
R15	1 k Ω , $\pm 5\%$, $\frac{1}{4}$ W Resistor	110000-102
R16, R17	220 Ω , $\pm 5\%$, $\frac{1}{4}$ W Resistor	110000-221
R18	330 Ω , $\pm 5\%$, $\frac{1}{4}$ W Resistor	110000-331
R19	220 Ω , $\pm 5\%$, $\frac{1}{4}$ W Resistor	110000-221
R20	1 k Ω , $\pm 5\%$, $\frac{1}{4}$ W Resistor	110000-102
R21-R24	39 k Ω , $\pm 5\%$, $\frac{1}{4}$ W Resistor	110000-393
R25-R28	1 k Ω , $\pm 5\%$, $\frac{1}{4}$ W Resistor	110000-102
R29-R32	470 Ω , $\pm 5\%$, $\frac{1}{4}$ W Resistor	110000-471
R33	100 k Ω , $\pm 5\%$, $\frac{1}{4}$ W Resistor	110000-101
R34-R37	470 Ω , $\pm 5\%$, $\frac{1}{4}$ W Resistor	110000-471
R38-R45	1 k Ω , $\pm 5\%$, $\frac{1}{4}$ W Resistor	110000-102
R46-R49	470 Ω , $\pm 5\%$, $\frac{1}{4}$ W Resistor	110000-471
R50-R57	1 k Ω , $\pm 5\%$, $\frac{1}{4}$ W Resistor	110000-102
R58-R60	100 Ω , $\pm 5\%$, $\frac{1}{4}$ W Resistor	110000-101
R61-R68	470 Ω , $\pm 5\%$, $\frac{1}{4}$ W Resistor	110000-471
R69, R70	220 Ω , $\pm 5\%$, $\frac{1}{4}$ W Resistor	110000-221
R71-R74	1 k Ω , $\pm 5\%$, $\frac{1}{4}$ W Resistor	110000-102
R75	220 Ω , $\pm 5\%$, $\frac{1}{4}$ W Resistor	110000-221
R76	100 k Ω , $\pm 5\%$, $\frac{1}{4}$ W Resistor	110000-104
R77-R79	1 k Ω , $\pm 5\%$, $\frac{1}{4}$ W Resistor	110000-102
R80	220 Ω , $\pm 5\%$, $\frac{1}{4}$ W Resistor	110000-221
R81	330 Ω , $\pm 5\%$, $\frac{1}{4}$ W Resistor	110000-331
R82, R83	0 Ω Resistor	110005-001
RN1, RN2	10 k Ω , 10 Pin, SIP Resistor	118002-103
Sockets		
1N, 1P	24-Pin Medium Insertion-Force Socket	79-42C24
2A, 2B	24-Pin Medium Insertion-Force Socket	79-42C24
3A, 3B	24-Pin Medium Insertion-Force Socket	79-42C24
2N, 2P	24-Pin Medium Insertion-Force Socket	79-42C24

(continued on next page)

I, ROBOT CPU PCB Assembly Parts List, continued

Designator	Description	Part No.
1A, 1B	28-Pin Medium Insertion-Force Socket	79-42C28
1C/D	28-Pin Medium Insertion-Force Socket	79-42C28
1D/E	28-Pin Medium Insertion-Force Socket	79-42C28
1E/F	28-Pin Medium Insertion-Force Socket	79-42C28
1H/F	28-Pin Medium Insertion-Force Socket	79-42C28
1H/J	28-Pin Medium Insertion-Force Socket	79-42C28
1J/K	28-Pin Medium Insertion-Force Socket	79-42C28
1K/L	28-Pin Medium Insertion-Force Socket	79-42C28
1L/M	28-Pin Medium Insertion-Force Socket	79-42C28
4C	28-Pin Medium Insertion-Force Socket	79-42C28
3E, 4E	40-Pin Medium Insertion-Force Socket	79-42C40
4/5K	40-Pin Medium Insertion-Force Socket	79-42C40
4/5L	40-Pin Medium Insertion-Force Socket	79-42C40
4/5M	40-Pin Medium Insertion-Force Socket	79-42C40
4/5N	40-Pin Medium Insertion-Force Socket	79-42C40
Transistors		
Q1, Q2	Type-2N3904 Transistor	34-2N3904
Q3, Q4	Type-2N6044 Transistor	34-2N6044
Q5	Type-2N3904 Transistor	34-2N3904
Miscellaneous		
3J	8-Station, Dual-Inline Package (DIP) Switch	160031-008
5E	8-Station, Dual-Inline Package (DIP) Switch	160031-008
Y1	12.069 MHz Crystal	144000-001
	Test Point (Acceptable substitute is part no. 020670-01)	179051-002
	Nylon Snap-In Fastener	81-4302

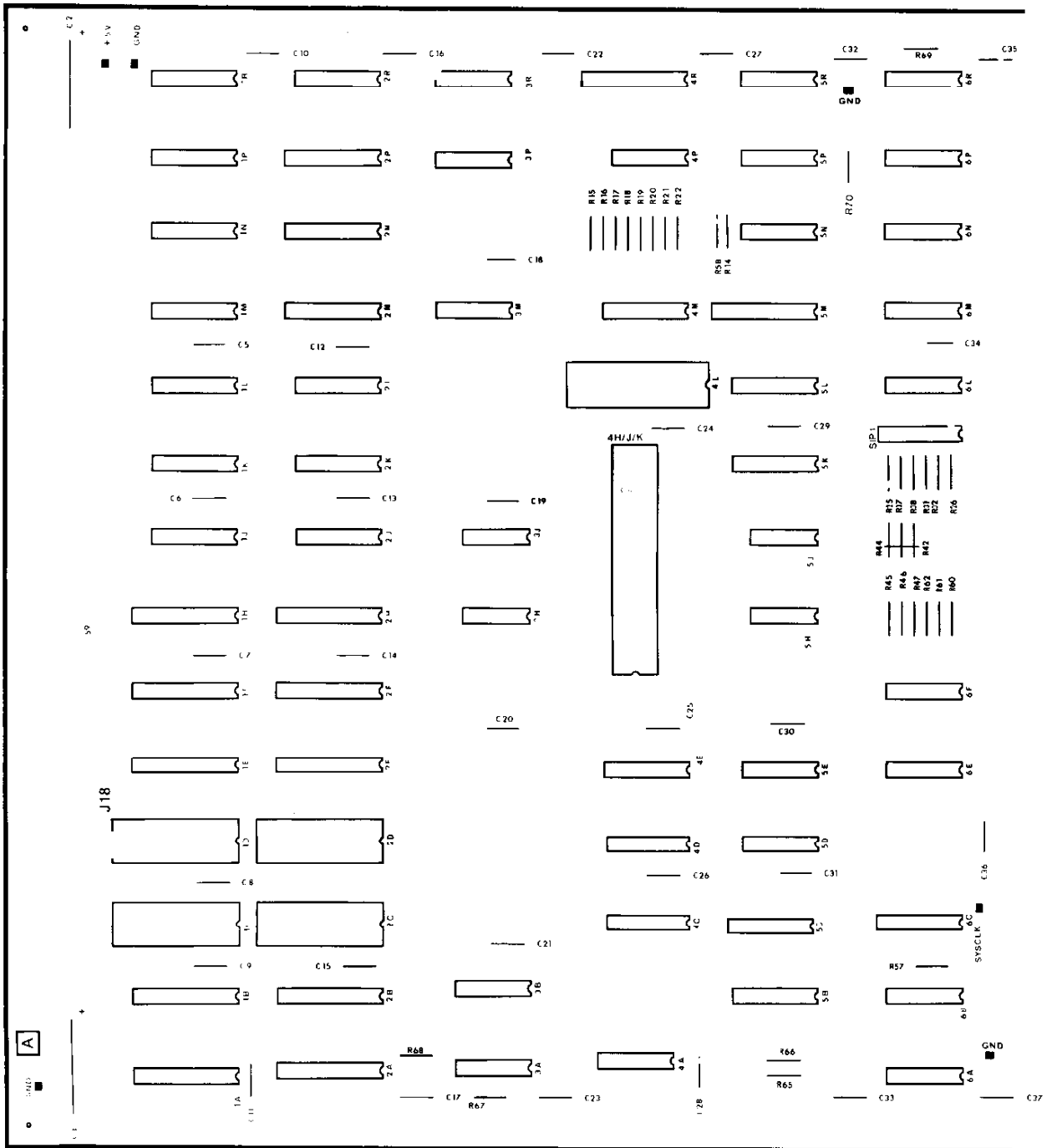

Figure 4-10 I, ROBOT Video PCB Assembly
A042683-21 A

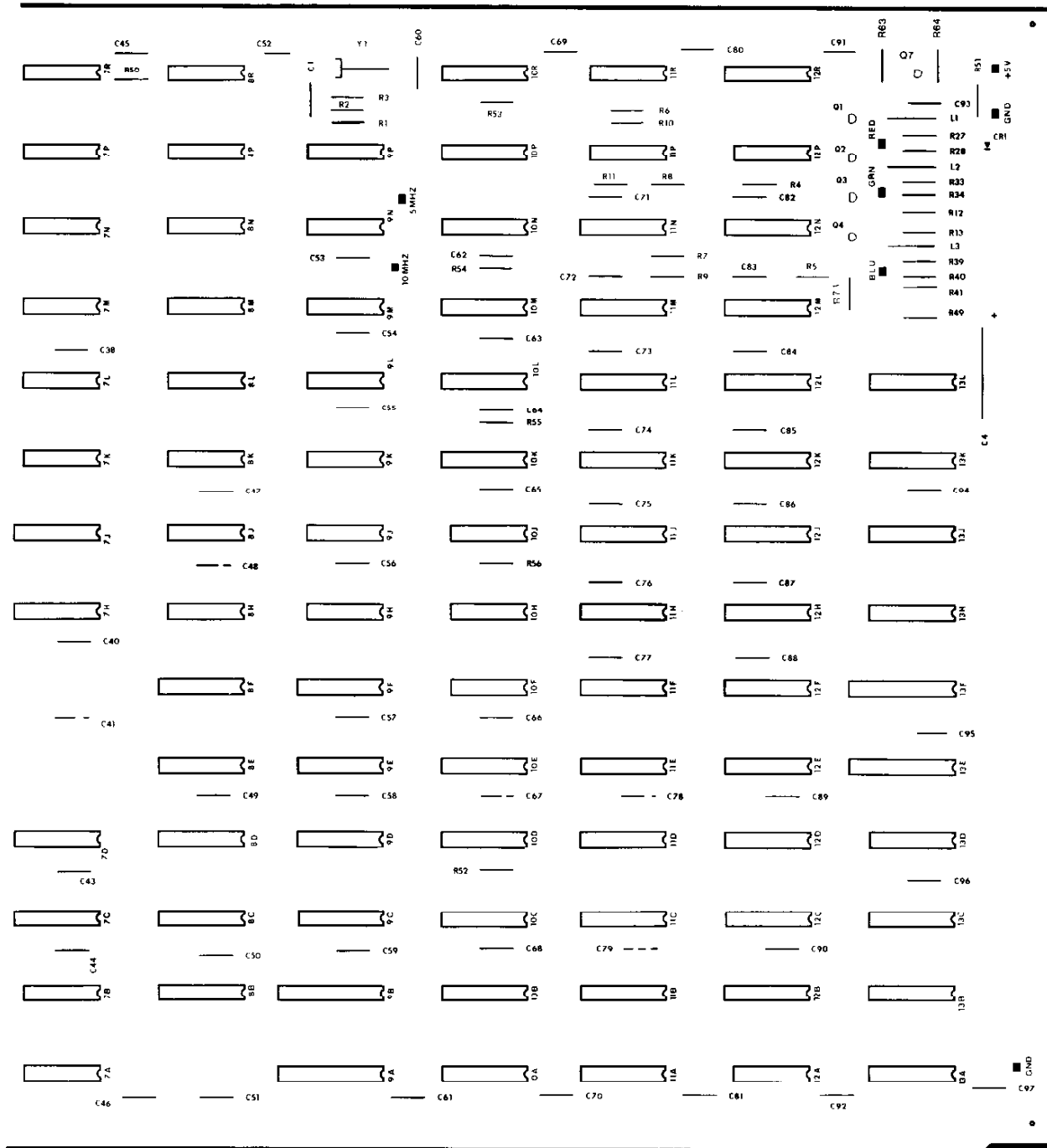

Figure 4-10 I, ROBOT Video PCB Assembly, continued
A042683-21 A

I, ROBOT Video PCB Assembly Parts List

Designator	Description	Part No.
Capacitors		
C1	0.1 μ F, 50 V, Ceramic Capacitor	122002-004
C2-C4	100 μ F, 25 V, Electrolytic Capacitor	24-250107
C5-C38	0.1 μ F, 50 V, Ceramic Capacitor	122002-004
C40, C41	0.1 μ F, 50 V, Ceramic Capacitor	122002-004
C43-C97	0.1 μ F, 50 V, Ceramic Capacitor	122002-004
Diode		
CRI	Type-MV5053 Light Emitting Diode	38-MV5053
Integrated Circuits		
1A	Type-74LS245 Integrated Circuit	37-74LS245
1B	Type-74LS244 Integrated Circuit	37-74LS244
1E	Type-74LS245 Integrated Circuit	37-74LS245
1F	Type-74LS244 Integrated Circuit	37-74LS244
1H	Type-74LS244 Integrated Circuit	37-74LS244
1J-1P	Type-74LS157 Integrated Circuit	37-74LS157
1R	Type-74LS163A Integrated Circuit	37-74LS163A
2A	Type-74LS245 Integrated Circuit	37-74LS245
2B	Type-74LS244 Integrated Circuit	37-74LS244
2E	Type-74LS245 Integrated Circuit	37-74LS245
2F	Type-74LS244 Integrated Circuit	37-74LS244
2H	Type-74LS374 Integrated Circuit	37-74LS374
2J-2L	Type-74LS157 Integrated Circuit	37-74LS157
2M, 2N	Type-2114-2 Integrated Circuit	90-7036
2R	Type-74LS195 Integrated Circuit	37-74LS195
3A	Type-74S32 Integrated Circuit	37-74S32
3B	Type-74LS08 Integrated Circuit	37-74LS08
3C	Type-74LS163A Integrated Circuit	37-74LS163A
3D	Type-74LS157 Integrated Circuit	37-74LS157
3E, 3F	Type-74LS163A Integrated Circuit	37-74LS163A
3H	Type-74LS257 Integrated Circuit	37-74LS257
3J, 3K	Type-74LS163A Integrated Circuit	37-74LS163A
3L	Type-74LS257 Integrated Circuit	37-74LS257
3M-3P	Type-74LS163A Integrated Circuit	37-74LS163A
3R	Type-74LS244 Integrated Circuit	37-74LS244
4A-4D	Type-74LS374 Integrated Circuit	37-74LS374
4E	Type-74S133 Integrated Circuit	137335-001
4F	Type-74LS374 Integrated Circuit	37-74LS374
4H/J/K	Custom Integrated Circuit	137410-101
4P	Type-74LS27 Integrated Circuit	37-74LS27
4R	Type-74S374 Integrated Circuit	37-74S374
5D	Type-74LS32 Integrated Circuit	37-74LS32
5E	Type-74125 Integrated Circuit	37-74125
5K, 5L	Type-74S157 Integrated Circuit	37-74S157
5M	Type-74LS273 Integrated Circuit	37-74LS273
5N	Type-74LS74 Integrated Circuit	37-74LS74

(continued on next page)

I, ROBOT Video PCB Assembly Parts List, continued

Designator	Description	Part No.
5P	Type-74S08 Integrated Circuit	37-74S08
5R	Type-74S04 Integrated Circuit	37-74S04
6A	Type-74LS125 Integrated Circuit	137317-001
6B	Type-74LS74 Integrated Circuit	37-74LS74
6C	Type-74LS257 Integrated Circuit	37-74LS257
6E	Type-74LS04 Integrated Circuit	37-74LS04
6F	Type-74125 Integrated Circuit	37-74125
6L, 6M	Type-7407 Integrated Circuit	37-7407
6N	Type-74S08 Integrated Circuit	37-74S08
6P	Type-74LS74 Integrated Circuit	37-74LS74
6R	Type-74S32 Integrated Circuit	37-74S32
7A, 7B	Type-74LS32 Integrated Circuit	37-74LS32
7J	Type-74S174 Integrated Circuit	137209-001
7K	Type-74LS32 Integrated Circuit	37-74LS32
7L	Type-74S08 Integrated Circuit	37-74S08
7M	Type-74LS74 Integrated Circuit	37-74LS74
7N	Type-74LS11 Integrated Circuit	137149-001
7P	Type-74S32 Integrated Circuit	37-74S32
7R	Type-74S00 Integrated Circuit	37-74S00
8B-8F	Type-74LS163A Integrated Circuit	37-74LS163A
8H	Type-74LS74 Integrated Circuit	37-74LS74
8J	Type-74S04 Integrated Circuit	37-74S04
8K	Type-74S10 Integrated Circuit	137236-001
8L	Type-74LS74 Integrated Circuit	37-74LS74
8M	Type-74LS04 Integrated Circuit	37-74LS04
8N	Type-74LS00 Integrated Circuit	37-74LS00
8P	Type-74LS74 Integrated Circuit	37-74LS74
8R	Type-74S08 Integrated Circuit	37-74S08
9A, 9B	Type-74LS374 Integrated Circuit	37-74LS374
9C, 9D	Type-74LS85 Integrated Circuit	37-74LS85
9E, 9F	Type-74S85 Integrated Circuit	37-74S85
9H	Type-74LS86 Integrated Circuit	37-74LS86
9J	Type-74S08 Integrated Circuit	37-74S08
9K	Type-74LS21 Integrated Circuit	137210-001
9L	Type-74S04 Integrated Circuit	37-74S04
9M	Type-74S74 Integrated Circuit	37-74S74
9N	Type-74S00 Integrated Circuit	37-74S00
9P	Type-74S04 Integrated Circuit	37-74S04
10A	Type-74S157 Integrated Circuit	37-74S157
10B	Type-74LS157 Integrated Circuit	37-74LS157
10D	Type-74LS163A Integrated Circuit	37-74LS163A
10E	Type-74S163 Integrated Circuit	137274-001
10H, 10J	Type-74LS74 Integrated Circuit	37-74LS74
10K	Type-74S160 Integrated Circuit	137341-001

(continued on next page)

I, ROBOT Video PCB Assembly Parts List, continued

Designator	Description	Part No.
10L	Type-74S163 Integrated Circuit	137274-001
10M-10R	Type-74S112 Integrated Circuit	137334-001
10F	Type-74S00 Integrated Circuit	37-74S00
11A	Type-74LS157 Integrated Circuit	37-74LS157
11B-11F	Type-74153 Integrated Circuit	37-74153
11F	Type-4164-15 Integrated Circuit	137339-150
11H	Type-4164-15 Integrated Circuit	137339-150
11J-11N	Type-4164-15 Integrated Circuit	137339-150
11P	Type-74S10 Integrated Circuit	137236-001
11R	Type-74S08 Integrated Circuit	37-74S08
12B-12E	Type-74153 Integrated Circuit	37-74153
12F	Type-4164-15 Integrated Circuit	137339-150
12H-12N	Type-4164-15 Integrated Circuit	137339-150
12P	Type-74S00 Integrated Circuit	37-74S00
12R	Type-74LS157 Integrated Circuit	37-74LS157
13A	Type-74LS163A Integrated Circuit	37-74LS163A
13B, 13C	Type-74189 Integrated Circuit	37-74189
13D	Type-74LS378 Integrated Circuit	137305-001
13E	Type-74LS240 Integrated Circuit	137251-001
13F	Type-74LS374 Integrated Circuit	37-74LS374
13H, 13J	Type-74LS158 Integrated Circuit	37-74LS158
13K, 13L	Type-74LS174 Integrated Circuit	37-74LS174
Read-Only and Random-Access Memories		
1C, 1D	Type-6116-2 RAM Integrated Circuit	137211-001
2C, 2D	Type-6116-2 RAM Integrated Circuit	137211-001
2P	Type-82S185 ROM Integrated Circuit	136029-124
4L	Type-82S09 RAM Integrated Circuit	137322-001
4M	Type-82S123 ROM Integrated Circuit	136029-125
7C	Type-82S123 ROM Integrated Circuit	136029-132
7D	Type-82S123 ROM Integrated Circuit	136029-133
7H	Type-82S131 ROM Integrated Circuit	136029-126
10C	Type-82S129 ROM Integrated Circuit	136029-131
Sockets		
1C, 1D	24-Contact, Medium-Insertion-Force Socket	79-42C24
2C, 2D	24-Contact, Medium-Insertion-Force Socket	79-42C24
4L	28-Contact, Medium-Insertion-Force Socket	79-42C28
4H/J/K	24-Contact, Medium-Insertion-Force Socket (uses two 24-pin sockets)	79-42C24
Transistors		
Q1-Q4	Type-2N3904 Transistor	34-2N3904
Q7	Type-2N3904 Transistor	34-2N3904

(continued on next page)

I, ROBOT Video PCB Assembly Parts List, continued

Designator	Description	Part No.
Resistors		
R1	680 Ω , $\pm 5\%$, $\frac{1}{4}$ W Resistor	110000-681
R2, 3	330 Ω , $\pm 5\%$, $\frac{1}{4}$ W Resistor	110000-331
R4	27 Ω , $\pm 5\%$, $\frac{1}{4}$ W Resistor	110000-270
R5	22 Ω , $\pm 5\%$, $\frac{1}{4}$ W Resistor	110000-220
R6-R8	27 Ω , $\pm 5\%$, $\frac{1}{4}$ W Resistor	110000-270
R9	22 Ω , $\pm 5\%$, $\frac{1}{4}$ W Resistor	110000-220
R10, R11	27 Ω , $\pm 5\%$, $\frac{1}{4}$ W Resistor	110000-270
R12, R13	220 Ω , $\pm 5\%$, $\frac{1}{4}$ W Resistor	110000-221
R14-R22	1 k Ω , $\pm 5\%$, $\frac{1}{4}$ W Resistor	110000-102
R25	1 k Ω , $\pm 5\%$, $\frac{1}{4}$ W Resistor	110000-102
R26	2.2 k Ω , $\pm 5\%$, $\frac{1}{4}$ W Resistor	110000-222
R27	100 Ω , $\pm 5\%$, $\frac{1}{4}$ W Resistor	110000-101
R28	220 Ω , $\pm 5\%$, $\frac{1}{4}$ W Resistor	110000-221
R31	1 k Ω , $\pm 5\%$, $\frac{1}{4}$ W Resistor	110000-102
R32	2.2 k Ω , $\pm 5\%$, $\frac{1}{4}$ W Resistor	110000-222
R33	100 Ω , $\pm 5\%$, $\frac{1}{4}$ W Resistor	110000-101
R34	220 Ω , $\pm 5\%$, $\frac{1}{4}$ W Resistor	110000-221
R37	1 k Ω , $\pm 5\%$, $\frac{1}{4}$ W Resistor	110000-102
R38	2.2 k Ω , $\pm 5\%$, $\frac{1}{4}$ W Resistor	110000-222
R39	100 Ω , $\pm 5\%$, $\frac{1}{4}$ W Resistor	110000-101
R40	220 Ω , $\pm 5\%$, $\frac{1}{4}$ W Resistor	110000-221
R41	560 Ω , $\pm 5\%$, $\frac{1}{4}$ W Resistor	110000-561
R42-R44	430 Ω , $\pm 5\%$, $\frac{1}{4}$ W Resistor	110000-431
R45	2.2 k Ω , $\pm 5\%$, $\frac{1}{4}$ W Resistor	110000-222
R46	4.7 k Ω , $\pm 5\%$, $\frac{1}{4}$ W Resistor	110000-472
R47	9.1 k Ω , $\pm 5\%$, $\frac{1}{4}$ W Resistor	110000-001
R49	22 k Ω , $\pm 5\%$, $\frac{1}{4}$ W Resistor	110000-223
R50	1 k Ω , $\pm 5\%$, $\frac{1}{4}$ W Resistor	110000-102
R51	220 Ω , $\pm 5\%$, $\frac{1}{4}$ W Resistor	110000-221
R52-R58	1 k Ω , $\pm 5\%$, $\frac{1}{4}$ W Resistor	110000-102
R60-R62	470 Ω , $\pm 5\%$, $\frac{1}{4}$ W Resistor	110000-471
R63	1 k Ω , $\pm 5\%$, $\frac{1}{4}$ W Resistor	110000-102
R64, R65	220 Ω , $\pm 5\%$, $\frac{1}{4}$ W Resistor	110000-221
R66	330 Ω , $\pm 5\%$, $\frac{1}{4}$ W Resistor	110000-331
R67-R69	33 Ω , $\pm 5\%$, $\frac{1}{4}$ W Resistor	110000-330
R70	1 k Ω , $\pm 5\%$, $\frac{1}{4}$ W Resistor	110000-102
R71	47 Ω , $\pm 5\%$, $\frac{1}{4}$ W Resistor	110000-470
SIP1	220 Ω , 8-Pin SIP Resistor	118007-221
Miscellaneous		
L1-L3	1 μ H Inductor	141007-001
Y1	20 MHz Crystal	144000-003

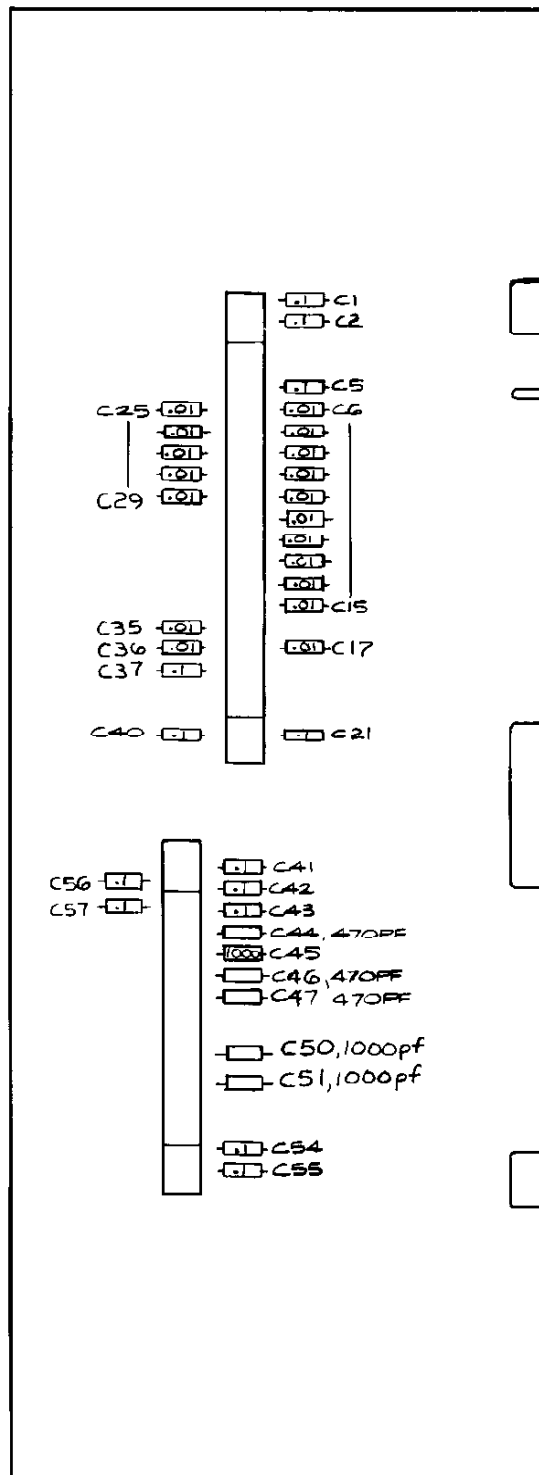

NOTICE TO ALL PERSONS RECEIVING THIS DRAWING
CONFIDENTIAL: Reproduction forbidden without the specific written permission of Atari, Inc., Sunnyvale, CA. This drawing is only conditionally issued, and neither receipt nor possession thereof conveys or transfers any right in, or license to use, the subject matter of the drawing or any design or technical information shown thereon, nor any right to reproduce this drawing or any part thereof. Except for manufacture by vendors of Atari, Inc., and for manufacture under the corporation's written license, no right is granted to reproduce this drawing or the subject matter thereof, unless by written agreement with or written permission from the corporation.

Figure 4-11 EMI Shield PCB Assembly
A037667-02 B

EMI Shield PCB Assembly Parts List

Designator	Description	Part No.
Capacitors		
C1, C2	0.1 μ F, +80%, -20%, 50 V Ceramic-Disk Capacitor	122002-104
C5	0.1 μ F, +80%, -20%, 50 V Ceramic-Disk Capacitor	122002-104
C6-C15	0.01 μ F, +80%, -20%, 25 V Ceramic-Disk Axial-Lead Capacitor	122005-103
C17	0.01 μ F, +80%, -20%, 25 V Ceramic-Disk Axial-Lead Capacitor	122005-103
C21	0.1 μ F, +80%, -20%, 50 V Ceramic-Disk Capacitor	122002-104
C25-C29	0.01 μ F, +80%, -20%, 25 V Ceramic-Disk Axial-Lead Capacitor	122005-103
C35, C36	0.01 μ F, +80%, -20%, 25 V Ceramic-Disk Axial-Lead Capacitor	122005-103
C37	0.1 μ F, +80%, -20%, 50 V Ceramic-Disk Capacitor	122002-104
C40	0.1 μ F, +80%, -20%, 50 V Ceramic-Disk Capacitor	122002-104
C43	0.1 μ F, +80%, -20%, 50 V Ceramic-Disk Capacitor	122002-104
C44	470 pF, 100 V, NPO Ceramic-Disk Axial-Lead Capacitor (Acceptable substitute is part no. 122013-471)	122016-471
C45	1000 pF, \pm 5%, 100 V, NPO Ceramic-Disk Axial-Lead Capacitor	122016-102
C46, C47	470 pF, 100 V, NPO Ceramic-Disk Axial-Lead Capacitor (Acceptable substitute is part no. 122013-471)	122016-471
C54	0.1 μ F, +80%, -20%, 50 V Ceramic-Disk Capacitor	122002-104
C57	0.1 μ F, +80%, -20%, 50 V Ceramic-Disk Capacitor	122002-104
Connectors		
P19	30-Pin Card-Edge Connector (Acceptable substitute is part no. 179046-030)	179073-030
P20	44-Pin Card-Edge Connector (Acceptable substitute is part no. 179046-044)	179073-044
Miscellaneous		
	Spacer	037873-01
	#4-40 \times 1/4 Cross-Recessed Pan-Head Screw	72-1404F

YOUR COMMENTS, PLEASE!

Your comments will assist Atari in improving our publications. The comments are an important part of preparing for revisions of game manuals. Please write in the space below.

If you have any technical questions about certain ATARI games products, or are requesting additional publications, we will immediately forward your note to the appropriate person.

Page: Comments:

Fill in if you wish a reply:

Name _____

Firm _____

Address _____

City _____ Country _____

Phone: Country Code _____ Local Number _____

Distributor

Operator

Other _____

First Fold

Attach
Necessary
Postage

Atari Ireland Limited
Attn.: Field Service/Coin-Op Division
Tipperary Town, Ireland

Second Fold

From:

Tape this edge



Warranty

Seller warrants that its printed-circuit boards and parts thereon are free from defects in material and workmanship under normal use and service for a period of ninety (90) days from date of shipment. Seller warrants that its video displays and laser-video disc players (in games supplied with displays and video-disc players) are free from defects in material and workmanship under normal use and service for a period of thirty (30) days from date of shipment. None of the Seller's other products or parts thereof are warranted.

If the products described in this manual fail to conform to this warranty, Seller's sole liability shall be, at its option, to repair, replace, or credit Buyer's account for such products which are returned to Seller during said warranty period, provided:

- (a) Seller is promptly notified in writing upon discovery by Buyer that said products are defective;
- (b) Such products are returned prepaid to Seller's plant; and
- (c) Seller's examination of said products discloses to Seller's satisfaction that such alleged defects existed and were not caused by accident, misuse, neglect, alteration, improper repair, installation, or improper testing.

In no event shall Seller be liable for loss of profits, loss of use, incidental or consequential damages.

Except for any express warranty set forth in a written contract between Seller and Buyer which contract supersedes the terms herein, this warranty is expressed in lieu of all other warranties expressed or implied, including the implied warranties of merchantability and fitness for a particular purpose, and of all other obligations or liabilities on the Seller's part, and it neither assumes nor authorizes any other person to assume for the Seller any other liabilities in connection with the sale of products by Seller.

The use of any non-Atari parts may void your warranty, according to the terms of the warranty. The use of any non-Atari parts may also adversely affect the safety of your game and cause injury to you and others. Be very cautious in using non-Atari-supplied components with our games, in order to ensure your safety.

Atari distributors are independent, being privately owned and operated. In their judgment they may sell parts or accessories other than Atari parts or accessories. Atari cannot be responsible for the quality, suitability or safety of any non-Atari part or any modification including labor which is performed by such distributor.



ATARI, INC.
790 SYCAMORE DRIVE
PO. BOX 906
MILPITAS, CALIFORNIA 95035
408/942-3100 • TELEX 35-7488