



TM-372  
1st printing

# OFF THE WALL™

## Universal Kit Installation Instructions

*Expandable to 3 controls*



*Available in joystick or whirly-gig versions*



*Cocktail version available*



# OFF THE WALL™



## Universal Kit Installation Instructions

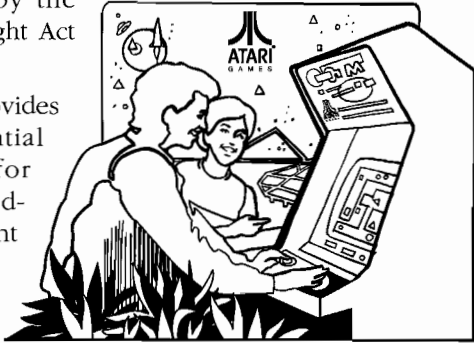
*Conversion kit for two- or three-player upright games*

## Copyright © 1991 by Atari Games Corporation. All rights reserved.

No part of this publication may be reproduced by any mechanical, photographic or electronic process, or in the form of a phonographic recording, nor may it be stored in a retrieval system, transmitted, or otherwise copied for public or private use, without permission from the publisher.

The game play, all graphic designs, this technical manual, its accompanying schematic diagrams, and the display manual are protected by the U.S. Copyright Act of 1976.

This Act provides for substantial penalties for violating federal copyright laws. Courts can impose infringing



articles while legal action is pending. If infringers are convicted, courts can order destruction of the infringing articles.

In addition, the Act provides for payment of statutory damages of up to \$50,000 per infringing transaction in certain cases. Infringers may also have to pay costs and attorneys' fees and face an imprisonment of up to five years as well as fines of up to \$250,000 in the case of individuals and up to \$500,000 in the case of corporations.

Atari Games Corporation will aggressively enforce its copyrights against infringers. We will use all legal means to immediately halt any manufacture, distribution, or operation of a copy of video games made by us. Anyone who purchases such copies risks forfeiting such a game.

Published by:  
Atari Games Corporation  
675 Sycamore Drive  
P.O. Box 361110  
Milpitas, California 95036

Printed in the U.S.A. 9/91

Produced by the Atari Games Technical Publications Department.

Writing and Editing: Andrea Dencker

Illustration and Design: Mary Ohanessian Sumner

# NOTICE RE. NON-ATARI PARTS

## WARNING

*Use of non-Atari parts or modifications of any Atari game circuitry may adversely affect the safety of your game, and may cause injury to you and your players.*

You may void the game warranty (printed on the inside back cover of this manual) if you do any of the following:

- Substitute non-Atari parts in the game.
- Modify or alter any circuits in the game by using kits or parts *not* supplied by Atari Games Corporation.

## NOTE

This equipment generates, uses, and can radiate radio frequency energy, and if not installed and used in accordance with the instruction manual, may cause interference to radio communications. It has been tested and found to comply with the limits for a Class A computing device pursuant to Subpart J of Part 15 of Federal Communications Commission (FCC) Rules, which are designed to provide reasonable protection against such interference when operated in a commercial environment. Operation of this equipment in a residential area or modification to this equipment is likely to cause interference, in which case the user, at his own expense, will be required to take whatever measures may be required to correct the interference. If you suspect interference from an Atari game at your location, check the following:

- All ground wires in the game are properly connected as shown in the game wiring diagram.
- The power cord is properly plugged into a grounded three-wire outlet.
- On games provided with an Electromagnetic Interference (EMI) ground plane, be sure that the game printed-circuit boards (PCBs) are properly installed on the EMI ground plane and that the end board is securely installed with **all** screws in place and tightened.

If you are still unable to solve the interference problem, please contact Customer Service at Atari Games Corporation. See the inside front cover of this manual for service in your area.

## SAFETY SUMMARY

The following safety precautions apply to all game operators and service personnel. Specific warnings and cautions will be found in this manual whenever they apply.

### WARNING

**Properly Ground the Game.** Players may receive an electrical shock if this game is not properly grounded! To avoid electrical shock, do not plug in the game until it has been inspected and properly grounded. This game should only be plugged into a grounded three-wire outlet. If you have only a two-wire outlet, we recommend you hire a licensed electrician to install a three-wire grounded outlet. If the control panel is not properly grounded, players may receive an electrical shock! After servicing any part on the control panel, check that the grounding wire is firmly secured to the inside of the control panel. After you have checked this, lock up the game.



**AC Power Connection.** Before you plug in the game, be sure that the game's power supply can accept the AC line voltage in your location. The line voltage requirements are listed in the first chapter of this manual.

**Disconnect Power During Repairs.** To avoid electrical shock, disconnect the game from the AC power before removing or repairing any part of the game. If you remove or repair the video display, be very careful to avoid electrical shock. High voltages continue to exist even after power is disconnected in the display circuitry and the cathode-ray tube (CRT). Do not touch the internal parts of the display with your hands or with metal objects! Always discharge the high voltage from the CRT before servicing it. Do this after you disconnect it from the power source. First, attach one end of a large, well-insulated, 18-gauge jumper wire to ground. Then momentarily touch the free end of the grounded jumper wire to the CRT anode by sliding the wire under the anode cap. Wait two minutes and do this again.



**Use Only Atari Parts.** To maintain the safety of your Atari game, use only Atari parts when you repair it. Using non-Atari parts or modifying the game circuitry may be dangerous, and could injure you and your players.

**Handle the CRT With Care.** If you drop the CRT and it breaks, it may implode! Shattered glass from the implosion can fly six feet or more.

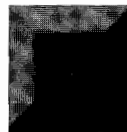
**Use the Proper Fuses.** To avoid electrical shock, use replacement fuses which are specified in the parts list for this game. Replacement fuses must match those replaced in fuse type, voltage rating, and current rating. In addition, the fuse cover must be in place during game operation.

### CAUTION

**Properly Attach All Connectors.** Make sure that the connectors on each printed circuit board (PCB) are properly plugged in. The connectors are keyed to fit only one way. If they do not slip on easily, do not force them. If you reverse a connector, it may damage your game and void your warranty.



**Ensure the Proper AC Line Frequency.** Video games manufactured for operation on 60 Hz line power (used in the United States) must not be operated in countries with 50 Hz line power (used in Europe). If a 60 Hz machine operates on 50 Hz line power, the fluorescent line ballast transformer will overheat and cause a potential fire hazard. Check the product identification label on your machine for the line frequency required.



### ABOUT NOTES, CAUTIONS, AND WARNINGS

In Atari publications, notes, cautions and warnings have the following meaning:

**NOTE** — A highlighted piece of information.

**CAUTION** — Equipment and/or parts can be damaged or destroyed if instructions are not followed. You will void the warranty on Atari printed-circuit boards, parts thereon, and video displays if equipment or parts are damaged or destroyed due to failure of following instructions.

**WARNING** — Players and/or technicians can be killed or injured if instructions are not followed.

# CONTENTS

## 1 Installation

How to Use This Manual .....	1-1
Cabinet Equipment Requirements .....	1-2
Tools Required .....	1-2
Inspecting the Kit .....	1-3
Preparing the Cabinet for the Kit Installation .....	1-7
Assembling the Control Panel .....	1-7
Connecting the JAMMA Harness .....	1-9
Installing the Off the Wall Game PCB .....	1-10
Installing the Bezel, Decals, Labels, and Attraction Assembly .....	1-10
Setting the Coin and Game Options .....	1-10
Maximizing Earnings .....	1-12
Game Play .....	1-12

## 2 Self-Test

Introduction .....	2-1
Entering and Exiting the Quick Self-Test .....	2-2
Entering and Exiting the Self-Test .....	2-3
Select Test Menu .....	2-3
Adjust Volume .....	2-3
Statistics .....	2-3
Game Options .....	2-5
Coin Options .....	2-5

Sound Board Test .....	2-6
Controls Test .....	2-6
RAM Test .....	2-6
ROM Test .....	2-6
Playfield Stamp Test .....	2-7
Motion Object Test .....	2-7
Monitor Tests .....	2-7
Color Test .....	2-7
Color Purity Test .....	2-8
Convergence Test .....	2-8

## 3 Troubleshooting and Maintenance

Introduction .....	3-1
Video Display Sync Problems .....	3-3
Troubleshooting .....	3-3
Removing and Replacing the Joystick Controls .....	3-3
Removing and Replacing the Whirly-Gig Controls .....	3-3
ROMs and RAMs .....	3-3

## 4 Parts Illustrations

See the List of Illustrations that follows.

## 5 Schematic Diagrams

See the List of Illustrations that follows.



# Statistics Sheet

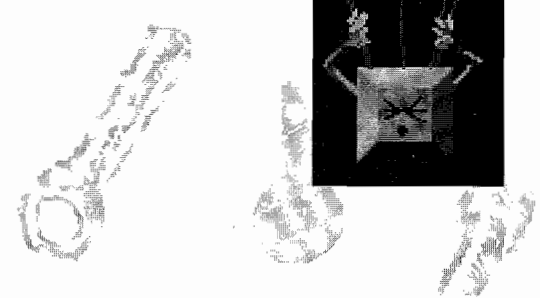
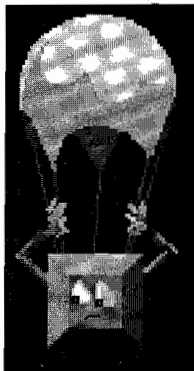
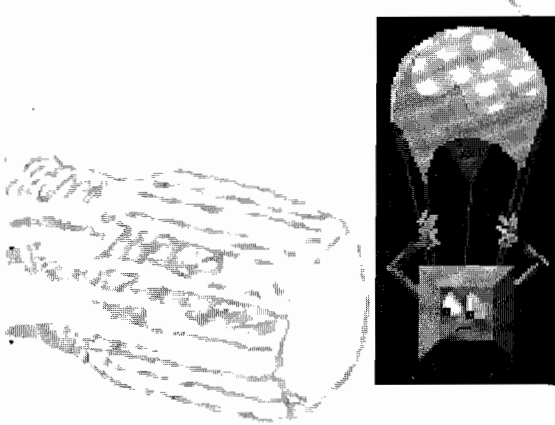
## ILLUSTRATIONS

Figure 1-1	Installed Kit Parts.....	1-3
Figure 1-2	Locations of Control Panel Holes to be Drilled.....	1-6
Figure 1-3	Locations of Control Panel Holes to be Drilled (Three-Player Game).....	1-7
Figure 1-4	Hole-Cutting Template for Off The Wall Kit Control Panel.....	1-11
Figure 1-5	Instructions Label for Monitor Bezel.....	1-13
Figure 2-1	Quick Self-Test Screen.....	2-2
Figure 2-2	Select-Test Screen.....	2-3
Figure 2-3	Statistics Screen.....	2-3
Figure 2-4	Histogram Screen.....	2-4
Figure 2-5	Game-Options Screen.....	2-5
Figure 2-6	Coin Options Screen.....	2-5
Figure 2-7	Sound Board Test Screen.....	2-6
Figure 2-8	Controls (Joysticks/Whirly-Gigs) Test Screen.....	2-6
Figure 2-9	RAM Tests Menu.....	2-7
Figure 2-10	ROM Test Screen.....	2-7
Figure 2-11	Playfield Stamp Test Screen.....	2-7
Figure 2-12	Motion Object Test Screen.....	2-8
Figure 2-13	Color Test Screen.....	2-8
Figure 2-14	Convergence Test Screen.....	2-8
Figure 4-1	Parts for Off the Wall Universal Kit with Whirly-Gig Controls (A049752-02 D) and with Joystick Controls (171097-002).....	4-2

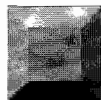
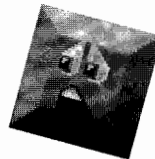
Figure 4-2	Wico 8-Way Short-Throw Joystick Assembly.....	4-3
Figure 4-3	Whirly-Gig (Encoder Pot) Assembly (A049722-01 A).....	4-4
Figure 4-4	Off the Wall Game PCB Assembly with Whirly-Gig Controls (A049727-02 A) and with Joystick Controls (A049727-01 B).....	4-5
Figure 4-5	JSA (JAMMA Stand-alone Audio) III PCB Assembly (A048974-07 A).....	4-6
Figure 5-1	Off the Wall Game PCB Assembly Schematic Diagram (049726-01 B)....	5-2
Figure 5-2	JSA Audio III Assembly Schematic Diagram (048973-01 C).....	5-7

## TABLES

Table 1-1	Equipment Requirements.....	1-2
Table 1-2	Contents of Off the Wall Kit.....	1-2
Table 1-3	JAMMA Pin and Wire Connections.....	1-4
Table 1-4	Third (Center) Player Pin and Wire Connections.....	1-6
Table 2-1	Summary of All Self-Test Screens.....	2-2
Table 2-2	Game Option Settings.....	2-4
Table 2-3	Coin-Option Settings.....	2-5
Table 2-4	When to Run the RAM Tests.....	2-7
Table 3-1	Troubleshooting Table.....	3-2
Table 3-2	Voltage Inputs and Test Points on the PCBs.....	3-3
Table 3-3	What ROM Problems Look Like.....	3-3

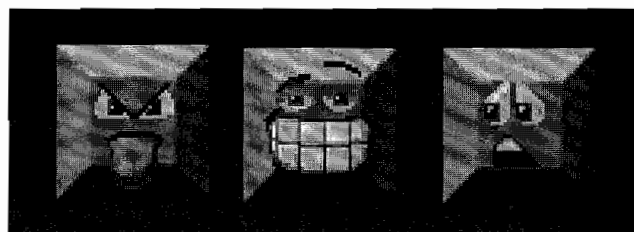


# N O T E S





# Installation



## HOW TO USE THIS MANUAL

The Off the Wall™ conversion kit provides several options. Standard in the kit are two sets of whirly-gig or joystick controls and all parts necessary to convert an upright game cabinet. ❖ To install three sets of controls in your wider cabinet, you can order additional controls (see page 1-8 for a list of parts). ❖ In addition, a separate version of this kit is available to install in cocktail games. A separate supplement to this manual, CO-372-01, describes how to install that version. ❖ This manual provides information for installing, testing, and troubleshooting the Off the Wall™ conversion kit. ❖ Chapter 1 describes how to install the Off the Wall kit in your cabinet.

This chapter also describes game play. ❖ Chapter 2 contains self-test procedures and additional diagnostic tests. The self-test is important in the Off the Wall game. You can troubleshoot the PC boards, main circuits, and controls using the screens in the self-test. You should regularly test the boards and controls with the self-test to keep your game in peak condition and at top earnings. ❖ Chapter 3 contains troubleshooting and maintenance procedures for the controls. ❖ Chapter 4 contains the kit parts list and parts illustrations. ❖ Chapter 5 contains the schematics for the Off the Wall game PCB.

**WARNING**

To avoid electrical shock, unplug the cabinet while installing the kit. After installation, plug the game only into a grounded 3-wire outlet.

**Cabinet Equipment Requirements**

Table 1-1 lists the equipment required in the cabinet into which you are installing the Off the Wall kit.

**CAUTION**

Do not unplug or plug in the Off the Wall game printed-circuit board (PCB) edge connector while the power is on. You could seriously damage the PCB.

**Tools Required**

- Drill with a 1/2-inch and 5/16-inch drill bits
- Phillips screwdriver
- Flat-blade screwdriver
- Socket wrench set and ratchet
- 5/32" hex wrench

Equipment	Specification
Video Display	Color RGB monitor Separate positive horizontal and vertical sync or negative composite sync Horizontal mounting Horizontal frequency: 15.750 KHz Vertical frequency: 60 Hz Video input: 1V to 3V peak-to-peak positive polarity
Control Panel	Metal only
Speaker	8 Ω, 10 W
Coin Counter	+5 VDC or +12 VDC
Power Cord	Three-conductor with ground
Power Supply	+5 VDC ± 0.25V @ 3.0 amps +12 VDC @ 1.0 amp -5 VDC @ 1.0 amp (optional)

**Table 1-1 Equipment Requirements**

- Wire cutters and strippers
- Straight edge
- Squeegee
- X-ACTO™ knife
- Insulated wire connectors (if you are installing a new JAMMA harness)
- Carbon paper
- Saber saw
- File
- Bandsaw
- Tape or glue

Part No.	Description
72-6608S	#6 x 1/2"-Long, Type AB, Pan-Head, Cross-Recessed Screws (4)
75-5112B	#10-24 x 3/4"-Long Black Carriage Bolts (12)
177026-0040	#10-24 Nut/Washer Assemblies (12)
038158-01	Product I.D. Label
039450-01	FCC Compliance Label
047205-01	Attraction Shield
047209-01	Control Panel Cover
049751-01	Control Panel Decal
049750-01	Side Panel Decals (2)
049749-01	Attraction Panel Film
049747-01	Monitor Bezel with Graphics
049743-01	Game Instructions Label for Control Panel
141026-001	.5"-Inside-Diameter Ferrite Split Beads (2)
160044-001	Snap-Action Switches (4)
A049722-01	Encoder Pot Whirly-Gig Control (2)*
175014-1040	#10 Flat Washers (12)
178032-002	#10 Wire & Cable Tie
178237-001	Red Button Assemblies (2)
178237-005	Blue Button Assemblies (2)
178265-001	L-Style Nylon Standoffs (4)
178283-008	Indicator Plates Labeled "Start/Action" (6)*
A046501-01	JAMMA Harness Assy.
A049753-01	Off the Wall Kit Game Board Set
TM-372	Off the Wall Universal Kit Installation Instructions (with control panel templates)

\*Your kit may instead include two joystick controls (part no. 171097-002) and six START/TURBO indicator plates (178283-012). Packaging materials are not listed. All parts are a quantity of 1, except as noted in parentheses.

**Table 1-2 Contents of Off the Wall Kit**

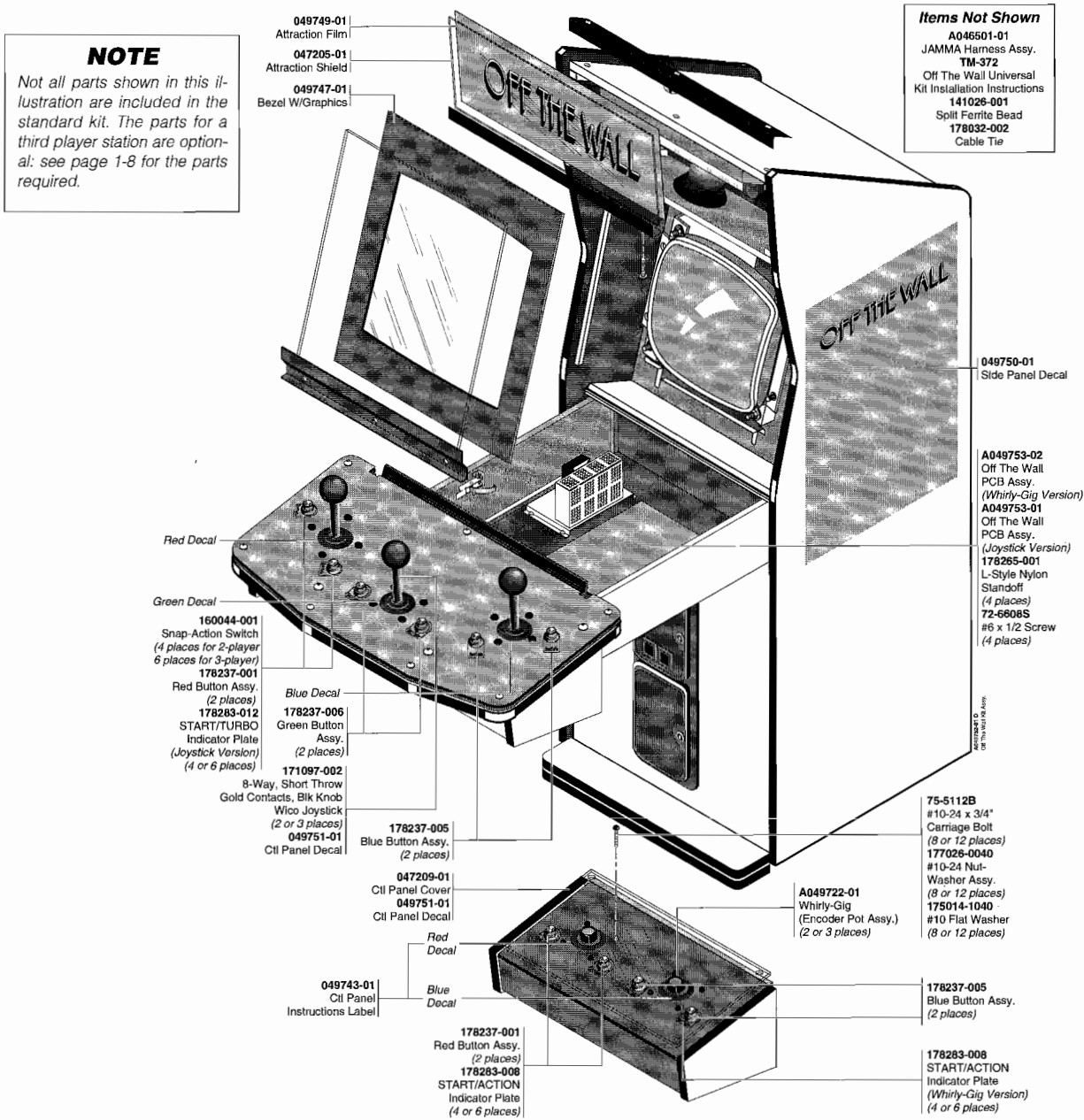


Figure 1-1 Installed Kit Parts

## Inspecting the Kit

Check to see that you have all the parts listed in the kit parts list in Table 1-2. If any part is missing or damaged, contact your distributor with the Off the Wall kit serial number, part number, and description of the missing or damaged parts, and date received.



Wire		Signal	Instructions
Pin	Color		
<b>Component Side</b>			
1	BN	GND	Connect to the 5V RTN (GND) terminal on the power supply. However, if you have 12V RTN, connect <i>one</i> of the BN wires at pin 1, 2, A, or B to the 12V RTN terminal.
2	BN	GND	Same as pin 1.
3	R	+5V	Connect the red +5V encoder pot wire of the left player to this pin. If you use joysticks, connect to the +5V terminal on the power supply. However, if your power supply has a +SENSE terminal, connect <i>one</i> of the R wires at pin 3, 4, C, or D to +SENSE instead of +5V.
4	R	+5V	Same as pin 3.
5	OR	-5V	Connect to the -5V terminal of the power supply. If -5V is not available, connect to the 12V RTN or the 5V RTN (GND) or leave it unconnected. <i>NOTE: If you do not have (or use) -5V, the maximum power to the speaker will be reduced by half.</i>
6	Y	+12V	Connect to the +12V terminal of the power supply. If your coin counter(s) require 12V, also connect to the + side of the coin counter(s).
7		<b>Key</b>	
8	BU/W	COIN CTR 1	Connect this wire to one side of the left 12V coin counter. <i>Note: Do not use 24V counters.</i> Connect the + side to +5V or +12V on the power supply, as appropriate.
9		Not used	
10	BN	SPKR +	Connect to the + terminal on the speaker. (This wire is part of a twisted pair.)
11		Not used	
12	R	RED	Attach to the video display.
13	BU	BLUE	Attach to the video display.
14	BK	VIDEO GND	Attach to the video display.
15	W	SELF-TEST	Use this wire if you want an external self-test switch. However, the kit already has a self-test switch on the PCB. <i>(If you connect an external self-test switch, switch off the switch on the PCB. Connect the wire to the N.O. terminal on the external self-test switch. Connect the common terminal of the switch to a BK/W wire [GND].)</i>
16	Y	LT COIN	Connect to the N.O. terminal of the left coin switch. Connect the common terminal of the switch to a BK/W wire.
17	W/BK	JAMMA START1	JAMMA start switch (optional)
18	W/BN	LT UP	Connect the orange encoder pot wire "CLK" of the left player to this pin. If you use joysticks, this signal is LT JOYST UP. Connect to the N.O. terminal of the switch. Connect the common terminal of the switch to one of the BK/W wires.
19	W/R	LT DN	Same as pin 18. Connect the yellow encoder pot wire "DIR" of the left player to this pin. If you use joysticks, this signal is LT JOYST DN.
20	W/OR	LT JOYST LT	Same as pin 18. Used only if joysticks are installed.
21	W/Y	LT JOYST RT	Same as pin 18. Used only if joysticks are installed.
22	W/GN	LT START/ACTION	Connect this wire to the N.O. terminal of both left START/ACTION switches (START/TURBO switches if joysticks are installed). Connect the common terminals of the switches to one of the BK/W wires.
23	W/BU	Not used	
24	W/V	Not used	
25	W/GY	Not used	
26	V	Not used	
27	BK/W	GND	Connect the green ground encoder pot wire of the left player to this pin. If you use joysticks, connect one of the BK/W wires at pin 27, 28, e, and f to the negative sense terminal of the power supply (if it exists) and one to the common terminals of the coin switches. Connect two of these wires to the common terminals of the control switches on the control panel.
28	BK/W	GND	Same as pin 27.
<b>NOTE:</b> If you install the optional third player station, you need to obtain an adaptor harness from Atari Games Customer Service. Table 1-4 shows the wiring of that harness.			

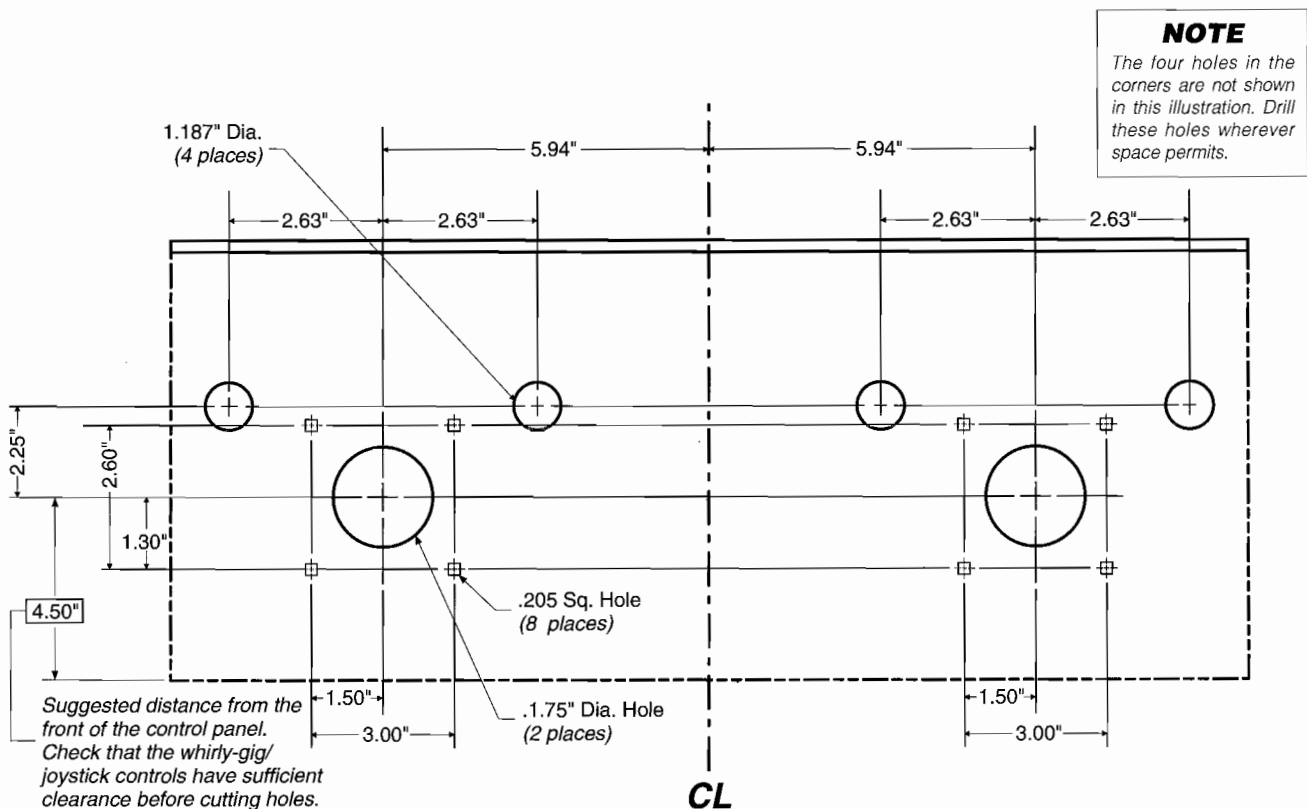
**Table 1-3 JAMMA Pin and Wire Connections**

Wire Pin	Color	Signal	Instructions
<b>Solder Side</b>			
<b>A</b>	BN	GND	Connect to the 5V RTN (GND) terminal on the power supply. However, if you have 12V RTN, connect <i>one</i> of the BN wires at pin 1, 2, A, or B to the 12V RTN terminal.
<b>B</b>	BN	GND	Same as pin A.
<b>C</b>	R	+5V	Connect the red +5V encoder pot wire of the right player to this pin. If you use joysticks, connect to the +5V terminal on the power supply. However, if your power supply has a +SENSE terminal, connect <i>one</i> of the R wires at pin 3, 4, C, or D to +SENSE instead of +5V.
<b>D</b>	R	+5V	Same as pin C.
<b>E</b>	OR	-5V	Connect to the -5V terminal of the power supply. If -5V is not available, connect to the 12V RTN or the 5V RTN (GND) or leave it unconnected. <i>NOTE: If you do not have (or use) -5V, the maximum power to the speaker will be reduced by half.</i>
<b>F</b>	Y	+12V	Connect to the +12V terminal of the power supply.
<b>H</b>		<b>Key</b>	
<b>J</b>	V/W	COIN CTR 2	Connect this wire to one side of the right 12V coin counter. Clip R26 on the game PCB if you use a second coin counter. <i>Note: Do not use 24V counters.</i> Connect the + side to +5V or +12V on the power supply, as appropriate.
<b>K</b>		Not used	
<b>L</b>	W	SPKR-	Connect to the - terminal on the speaker. (This wire is one of a twisted pair.)
<b>M</b>		Not used	
<b>N</b>	GN	GREEN	Attach to the video display.
<b>P</b>	BN	COMPSYNC	Attach to the video display.
<b>R</b>	GY	Service 1	Optional: attach to the N.O. terminal of the 1st or main service switch.
<b>S</b>		Not used	
<b>T</b>	OR	RT COIN	Connect to the N.O. terminal of the right coin switch. Connect the common terminal of the switch to a BK/W wire.
<b>U</b>	Y/BK	JAMMA START2	JAMMA start switch (optional)
<b>V</b>	Y/BN	RT UP	Connect the orange encoder pot wire "CLK" of the right player to this pin. If you use joysticks, this signal is RT JOYST UP. Connect to the N.O. terminal of the switch. Connect the common terminal of the switch to one of the BK/W wires.
<b>W</b>	Y/R	RT DN	Same as pin V. Connect the yellow encoder pot wire "DIR" of the right player to this pin. If you use joysticks, this signal is RT JOYST DN.
<b>X</b>	Y/OR	RT JOYST LT	Same as pin V. Used only if joysticks are installed.
<b>Y</b>	Y/W	RT JOYST RT	Same as pin V. Used only if joysticks are installed.
<b>Z</b>	Y/GN	RT START/ACTION	Connect this wire to the N.O. terminal of both right START/ACTION switches (START/TURBO switches if joysticks are installed). Connect the common terminal of the switch to one of the BK/W wires.
<b>a</b>	Y/BU	Not used	
<b>b</b>	Y/V	Not used	
<b>c</b>	Y/GY	Service 2	Optional: attach to the N.O. terminal of the 2nd service switch.
<b>d</b>	GY/W	Not used	
<b>e</b>	BK/W	GND	Connect the green ground encoder pot wire of the right player to this pin. If you use joysticks, connect one of the BK/W wires at pin 27, 28, e, or f to the negative sense terminal of the power supply (if it exists) and one to the common terminals of the coin switches. Connect two of these wires to the common terminals of the control switches on the control panel.
<b>f</b>	BK/W	GND	Same as pin e.

Table 1-3 JAMMA Wire Connections, Continued

Pin	Wire Color	Signal	Instructions
1	BK	GND	Connect the green ground encoder pot wire of the center player to this pin. If you use joy sticks, connect to the common terminal of the center player control switches.
2	R/W	+5V	Connect the red +5V encoder pot wire of the center player to this pin. However, not used if joy sticks are installed.
3	W/BU	CCNT-CR	Not used.
4	W/GY	SERVICE 3	Optional: attach to the N.O. terminal of the 3rd service switch.
5	W/Y	COIN CR	Not used.
6	W	JAMMA START 3	Optional start software.
7	BN	UP 3	Connect to the N.O. terminal of the Joystick Up switch. Connect the common terminal of the switch to the GND wire. If you use whirly-gigs, connect the orange encoder pot wire "CLK" of the center player to this pin.
8	R	DN 3	Same as pin 7. If you use whirly-gigs, connect the yellow encoder pot wire "DIR" of the center player to this pin.
9	OR	LF 3	Same as pin 7. Not used with whirly-gigs.
10	Y	RT 3	Same as pin 7. Not used with whirly-gigs.
11	GN	START/ACTION	Connect to the N.O. terminal of both START/ACTION or START/TURBO switches. Connect the common terminal of the switch to the GND wire.
12	BU	—	Not used.
13	V	—	Not used.
14	—	—	—
15	—	—	—

**Table 1-4 Third (Center) Player Pin and Wire Connections**



**Figure 1-2 Locations of Control Panel Holes to be Drilled (Two-Player Game)**

# Preparing the Cabinet for the Kit Installation

## WARNING

To avoid electrical shock, unplug the cabinet while installing the kit. After installation, plug the game only into a grounded 3-wire outlet.

Figure 1-1 shows almost all kit parts installed in a typical cabinet. Use this illustration as a guide while you install the parts.

1. Turn off power to the game, and unplug the power cord.
2. Remove the following from the cabinet:
  - Existing PCBs
  - Game harness, if it is not Japan Amusement Machinery Manufacturers Association (JAMMA)-compatible
  - Control panel decals, labels, and controls
  - Side decals, graphics, and adhesive. If the cabinet sides are damaged, repair them before putting on the new decals.

- Video display (monitor) shield, display bezel, attraction shield, and marquee.

3. Wipe down and vacuum the cabinet. Paint the cabinet, if required.

## Assembling the Control Panel

### Parts Needed for this Kit

To assemble the control panel, you need the control panel hole-cutting template, which is printed on page 1-11. (If you would like an actual-size template for three player stations, contact Atari Games Customer Service at one of the locations printed on the inside front cover of this manual). Cut out the template sheet from this manual.

### For Two Players

If you are installing controls for *two* players, you will also need the following parts from the kit:

- Clear cover for the control panel
- Control panel decal
- Two red and two blue button assemblies
- Four snap-action switches

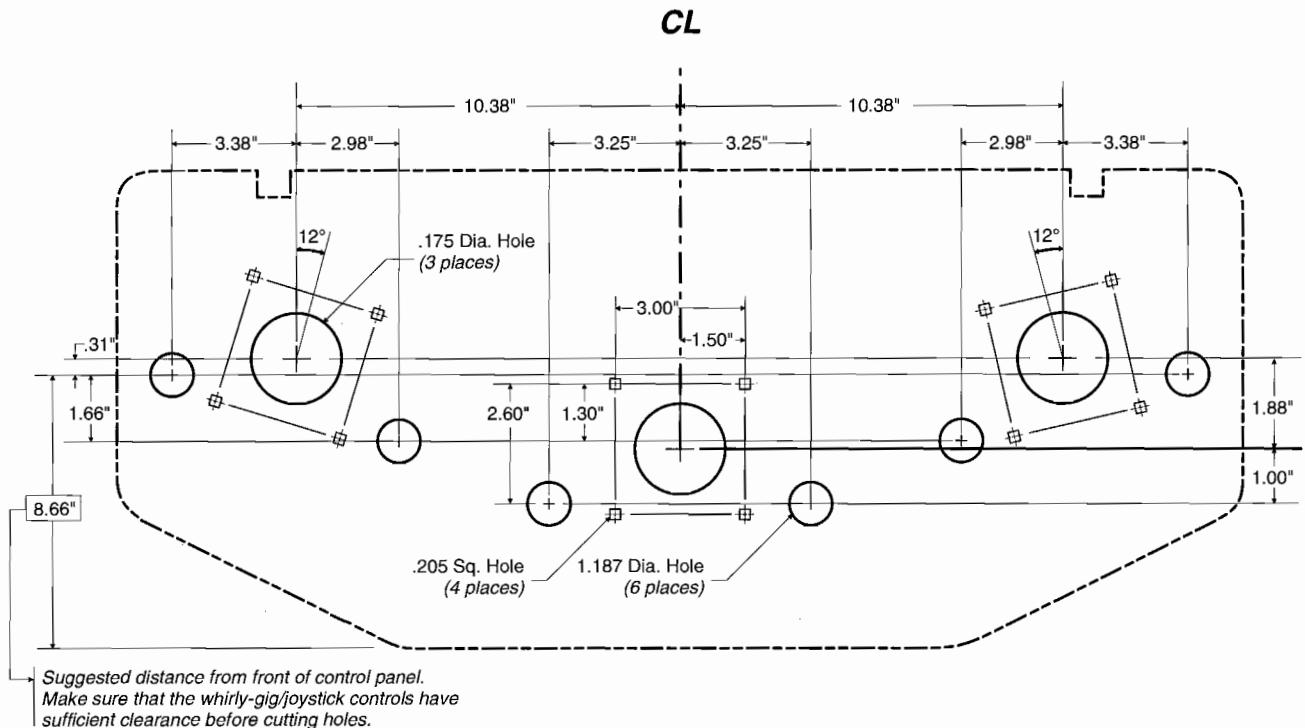


Figure 1-3 Locations of Control Panel Holes to be Drilled (Three-Player Game)

### Parts Needed for Additional (Third) Player Controls

Because few locations support wide games, Atari Games designed this kit to accommodate two players using joysticks or whirly-gigs. However, if you have a suitable cabinet, you can install this kit for three players. To fit three joysticks or whirly-gigs and sets of buttons onto a control panel, you must have a Street Fighter, Gauntlet, or similar style of cabinet with a wide control panel. Use the two extra START/TURBO or START/ACTION indicator plates already included in your kit. The additional parts required are available from Atari Games Customer Service and are as follows:

#### Order these parts to add a third joystick control:

- One joystick control (part no. 171097-002)
- Two green button assemblies (part no. 178237-006)
- A third-player adaptor harness (part no. A049811-01)
- Four #10-24 x 3/4"-long black carriage bolts (part no. 75-5112B)

- Four #10-24 nut/washer assemblies (part no. 177026-0040)
- Two snap-action switches (part no. 160044-001)

#### Order these parts to add a third whirly-gig control:

- One whirly-gig control (part no. A049722-01),
- Two green button assemblies (part no. 178237-006)
- A third-player adaptor harness (part no. A049811-01)
- Four #10-24 x 3/4"-long black carriage bolts (part no. 75-5112B)
- Four #10-24 nut/washer assemblies (part no. 177026-0040)
- Two snap-action switches (part no. 160044-001)

The four short wires on each whirly-gig control are connected to the JAMMA harness and 3rd-player harness as shown in Tables 1-3 and 1-4.

- Four control-panel indicator plates (labeled "Start/Turbo" if you have joysticks or "Start/Action" if you have whirly-gigs)
- Two joystick or two whirly-gig controls
- Eight #10-24 x 3/4"-long black carriage bolts, flat washers, and nut/washer assemblies for the joysticks or whirly-gigs
- Four #10-24 x 3/4"-long black carriage bolts, flat washers, and nut/washer assemblies for the corners of the control panel cover

#### For Three Players

If you are installing *three* player controls, you should use the two extra indicator plates included in your kit. The control-panel decal included is wide enough to



cover a wider control panel. You will need to purchase the additional parts listed in the box above.

#### Installing the Parts

1. Using carbon paper, transfer the whirly-gig/joystick mounting pattern from the template to the control panel. Save the template. Also refer to Figure 1-2 or 1-3 for the exact locations of all holes.
2. Drill four 1/8" holes in the metal control panel for each whirly-gig's/joystick's mounting bolts.
3. Using a saber saw, carefully cut out the large holes for the joysticks/whirly-gigs. Deburr the sharp edges with a file.
4. Lay the plexiglass cover over the top of the control panel and mark the outside shape of the panel on the plastic. Also mark the button holes as close as possible to the locations shown on the template. Lastly, mark the positions of the four holes that will be used for securing the cover to the control panel. These four holes can be placed anywhere near the corners—wherever space permits.
5. Using a bandsaw, cut the control panel cover to its correct outside shape.



**WARNING**

*Wear safety glasses when drilling the plastic control panel cover. Use care to avoid shattering or chipping the plastic.*

6. Tape or glue the template to the plexiglass cover. To start the saber saw cut, drill a 1/2" hole inside the whirly-gig/joystick holes and the button holes.
7. Saw out the two large whirly-gig/joystick holes and the button holes.
8. Drill the four 5/16" holes that will be used to mount the cover to the control panel and the 5/16" holes to mount the joysticks or whirly-gigs.
9. To prevent injury, carefully deburr all the edges of the plexiglass cover.
10. Install the control panel decal on the control panel. Use a sharp X-ACTO knife to trim the outside edge and to cut out the holes for the controls. Punch out the round instruction decals from the sheet and mount them over the whirly-gig/joystick holes: left = red, center (if used) = green, and right = blue.
11. Install the cover on the control panel with the four 3/4"-long carriage bolts, washers, and locknuts.
12. Install the joysticks/whirly-gigs using the 3/4"-long carriage bolts and #10-24 nut/washer assemblies.
13. Install the button assemblies and indicator plates as shown in Figure 1-1.

For maintenance and servicing information on the joystick and whirly-gig controls, refer to Chapter 3 of this manual.

## Connecting the JAMMA Harness

1. If your game cabinet does not already have a JAMMA harness, install the JAMMA harness in the cabinet.
2. Install the split beads on the harness as close to the PCB edge connector as possible. Hold the beads on the harness with the tie wraps included in the kit.

**CAUTION**

*You must install the split beads included in the kit on the JAMMA harness to meet FCC requirements.*

3. Using Table 1-3 for wiring information, connect the JAMMA harness to existing component harnesses. Use crimp splices or butt soldering.

**WARNING**

*Do not simply tie the wires together. If you do, you could cause intermittent problems, loose connections, oxidation, or a fire.*

### Connecting Power Wires

1. Connect the wires on the JAMMA harness to the wires for the power supply, as shown in Table 1-3. The Off the Wall kit requires +5V and +12V. If -5V is available, it should be used too. Tie off any other voltage wires on the power supply besides +5V, -5V, and +12V.

There is more than one wire for each voltage in the JAMMA harness. Use more than one wire for each voltage (connecting them as described in Table 1-3) so that the power wiring does not overload and burn.

### Connecting Video Display Wires

**NOTE**

*The JAMMA harness provides only negative composite sync. If your video display requires separate positive sync, see Chapter 3 for alternative wiring.*

Connect the wires designated for the red, green and blue video guns along with the sync and ground wires, according to Table 1-3.

### Connecting Coin Door Wires

1. Connect the wires on the JAMMA harness to the coin switches and meter according to Table 1-3.
2. Connect one terminal of the door lamps to one of the BK/W wires. Connect the other terminal of the door lamps to the R wire supplying +5V.

**NOTE**

*Do not use -5V for the coin door lamps. -5V is required for audio.*

Some games have separate power supply outputs for the coin door lamps. If you choose to use these outputs, make sure you connect both terminals of each lamp to the terminals on the power supply.

## Connecting the Control Wires

Connect the joystick or whirly-gig harness and the button harnesses to the JAMMA harness using crimp splices or butt soldering, according to the information in Tables 1-3 and 1-4.

## Installing the Optional Volume Switch(es)

If you want to install an easily accessible digital volume control, the Off the Wall game PCB provides pins near its edge for this purpose. You can install either a momentary center-off toggle switch or two pushbutton switches (for volume up and volume down) in an accessible area such as the coin door opening. See page 5-5 in this manual for the wiring diagrams of both types of switches. These switches will control the volume during the attract and game play modes.

## Grounding the Cabinet

Find the ground lead (green) of the 115V input power line. Connect this lead in daisy-chain fashion to a bare metal part of the coin door, the control panel, the video display, and the power supply. This AC ground must be of #18 AWG wire or larger.

---

### **WARNING**

*For the safety of players, you must connect the green ground wire as indicated above.*

---

## Checking the JAMMA Connections

Before plugging in the game PCB, turn on the power to the game, and check +5 Volts on pins 3, 4, C, and D of the JAMMA connector; +12 Volts on pins F and 6; and -5 Volts on pins E and 5.

Check that the video display and the attraction lamp have power. Now turn off the power to the game.

## Installing the Off the Wall Game PCB

1. After you have checked the power on the JAMMA connector (above), install the Off the Wall game board set in the cabinet. Use the nylon standoffs and four #6 x 1/2" large screws in the kit.
2. Connect the JAMMA connector to the PCB.
3. Secure the JAMMA harness away from the PCB with cable ties.
4. If you have installed *three* player stations, plug in the 3rd-player adaptor harness into the connector

labeled *JPL3-CR* on the Game PCB. This adaptor harness is not keyed, so make sure the wires exit from the PCB — they should not be draped over the board. No components will be damaged, however, if you plug the connector in backwards: the center player controls will just not work.

5. Turn on the power to the game. Check that the game PCBs function. If a video picture is not present, see Chapter 3.

## Installing the Bezel, Decals, Labels, and Attraction Assembly

The bezel, decals, labels, and attraction assembly are shown assembled in a cabinet in Figure 1-1.

### Installing the Display Bezel

Find the cardboard display bezel in the kit. This bezel can accommodate both 19-inch and 25-inch video displays. Follow the instructions on the back of the bezel, and cut the hole and outside edges as required. If the bezel is missing from your kit, you can use a plain black bezel in the cabinet. Then cut out the game instructions shown in Figure 1-4, and adhere that label to the bottom center of the bezel.

### Installing the Product ID and FCC Label

Place the product ID label (part no. 038158-01) and FCC compliance label (part no. 039450-01) on the back of the cabinet.

### Installing the Side Panel Decals

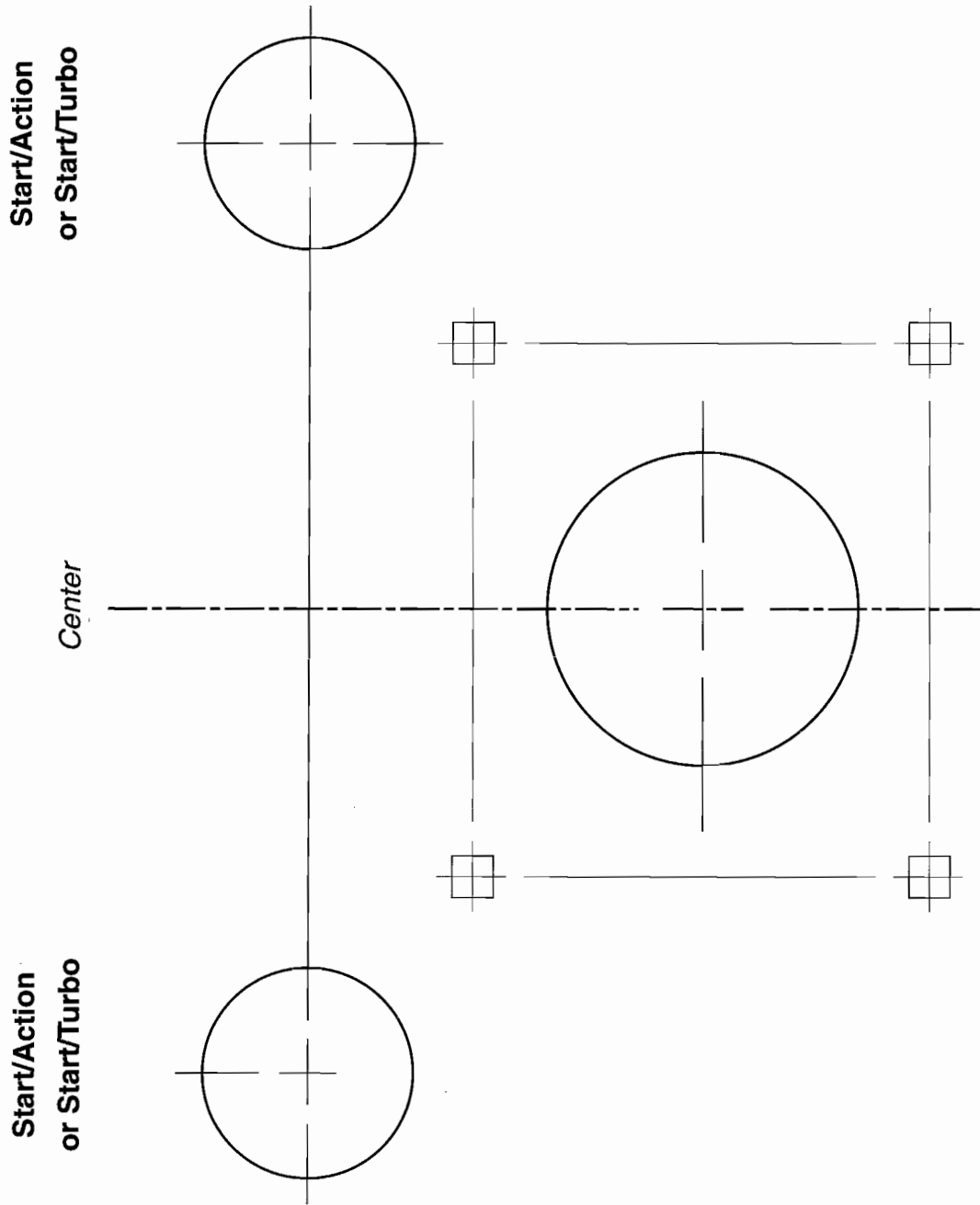
Find the side panel decals in the kit. Wet the left and right side panels of the cabinet with slightly soapy water. Then position the decals as shown in Figure 1-1. Remove any wrinkles in the artwork using a squeegee. Allow the sides to dry.

### Installing the Attraction Assembly

Find the Off the Wall attraction shield and the attraction film in the kit. Using the existing shield as a template, cut the shield and film to size, if necessary. Install them on the cabinet as shown in Figure 1-1.

## Setting the Coin and Game Options

Set the coin and game options in the self-test. See Chapter 2 for information about the option settings. If



Start/Action  
or Start/Turbo

Center

Start/Action  
or Start/Turbo

Figure 1-4 Hole-Cutting Template for Off the Wall™ Kit Control Panel



you have installed *three* player stations, you must set the game options screen in the self-test to three players. *Otherwise the software will not recognize the third set of controls.*

## Maximizing Earnings

For maximum earnings, regularly maintain your Off the Wall game following the instructions in Table 3-1, in Chapter 3.

When you set up the game and when you collect money, perform the automated self-test and check the controls with the Controls Test in the self-test.

## Game Play

This section describes the theme of the Off the Wall game and the game play features.

### Introduction

Off the Wall™ is a fun new game with a universal appeal. It's easy to play, difficult to master, and a real test of reflex and quickness. Players try to keep a ricocheting ball in play while hitting and destroying blocks that protect the goal.

### Play Mode

Off the Wall is a simultaneous game including a join-in-anytime feature. It's even expandable to three players just by making a change in self-test and adding another set of controls and harness.

The object of the game is to keep one ball in play by ricocheting it off the walls and bricks of the playfield. Bricks are destroyed by hitting them with the ball. Eliminating bricks exposes the exit/goal a little more each time. White-colored bricks are indestructible and cannot be destroyed.

The player who puts the ball in the exit scores a bonus for each remaining brick on the playfield.

Each player begins the game with three balls. When all balls are exhausted, the game is over. At the beginning of the game, each player launches a ball into the playfield. As long as one ball remains active on the playfield, no one will score a lost ball. Any new ball lost within four seconds of being launched will not result in a lost ball. After a short period, a single ball on the playfield will split in two and double the action!

Player controls consist of a whirly-gig and Action button. The whirly-gig controls the direction of a paddle along the player's wall. Pressing the Action button allows for very fast movement of the paddle along the wall.

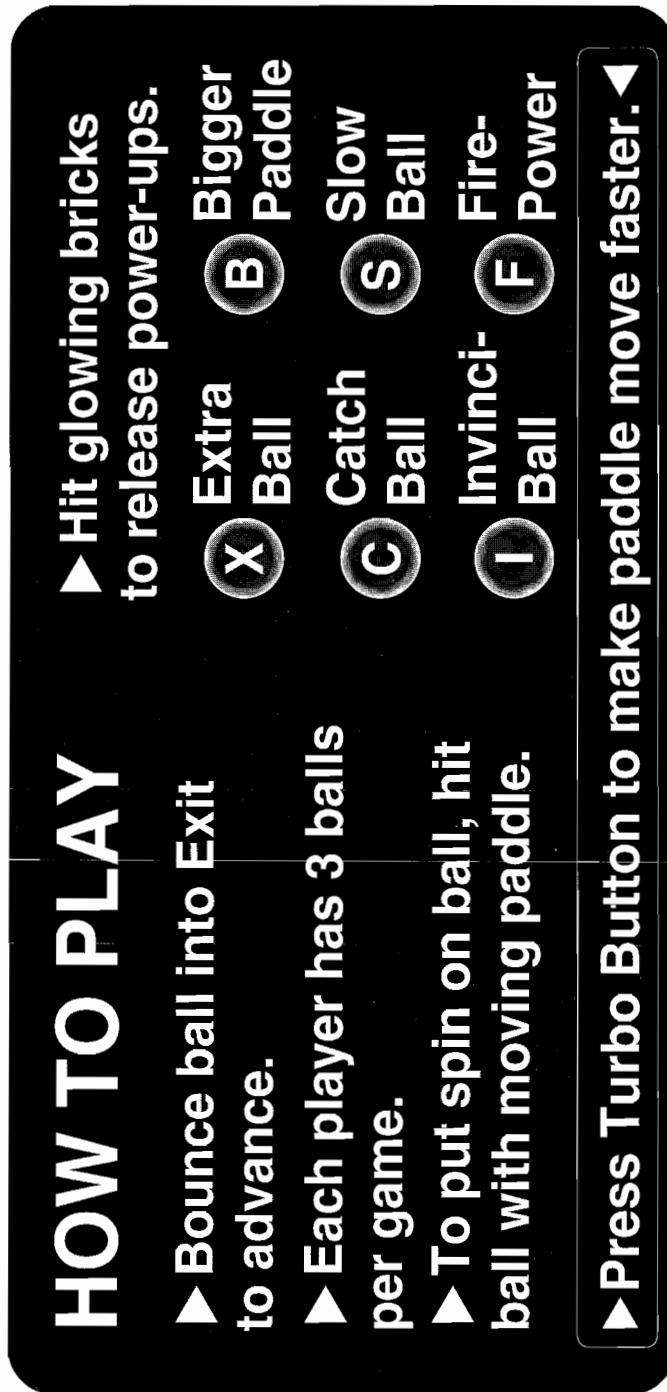
Glowing white bricks release Special Powers when hit with a ball. The power will drift towards the player who last hit the ball. If the ball is moving fast and furiously, the Special Powers will move in various directions before being captured.

### Special Powers

- Extra Ball—an extra life
- Catch Ball—the ability to catch, then release the ball
- Invinci-ball—the ball destroys all bricks in its path
- Bigger Paddle—a larger hitting surface
- Slow Ball—slows down the speed of the ball
- Firepower—shooting feature

Off the Wall has over 50 waves of variety! Each wave has a different arrangement of bricks on the playfield. A few of these include rotating/moving bricks, regenerating bricks, moving exits, etc.

Every four rounds is a Sudden Death Round. This feature is only in multi-player games. One ball is launched and players duel it out to see who is the last survivor.

**NOTE**

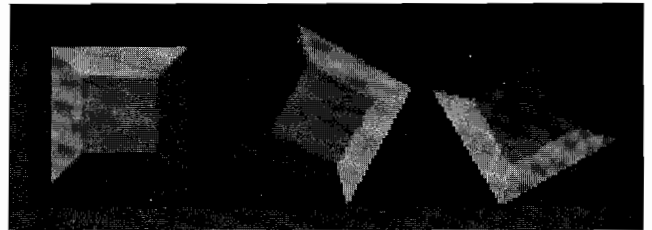
If you do not have the Off the Wall™ monitor bezel, cut out this game instruction label and adhere it to the bottom center of the monitor bezel.

If you install whirly-gig controls, be sure to black out the last line of this label, since it no longer applies. Use a permanent black marker or black tape. If you install joystick controls, do not alter this label.

Figure 1-5 Instructions Label for Monitor Bezel

# NOTES

# Self-Test



## INTRODUCTION

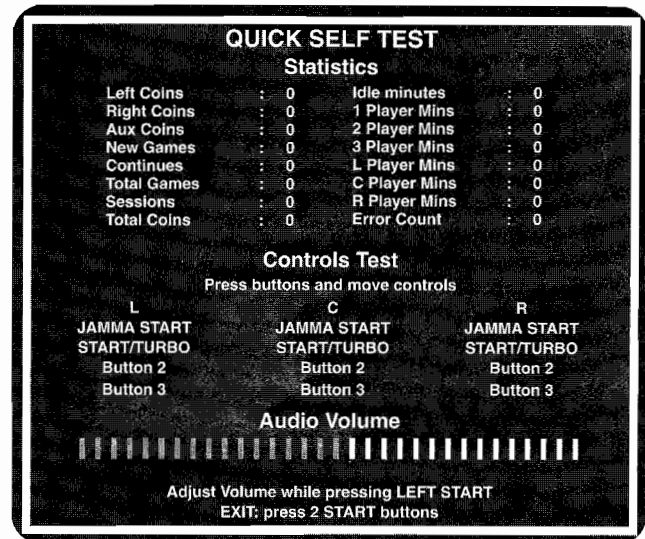
Use the Off the Wall™ self-test to check the condition of the game circuitry and controls. You will see the self-test information on the video display and hear the sound test information through the speakers. You do not need any additional equipment to perform the self-test. ❖ You should perform the self-test when you first set up the game, each time you collect the money, or when you suspect game failure. ❖ This chapter shows the screens in the self-test and explains each of the tests. The screens and explanations are arranged in the order they appear in the self-test. Table 2-1 lists all of the self-test screens and their purposes.

## Entering and Exiting the Quick Self-Test

To enter the quick self-test, hold down any button on the control panel and turn on the game power switch. This summary screen shows all the statistics, the controls test, whether joysticks or whirly-gigs are installed, and the volume adjustment band. These items are described in more detail later in this chapter.

### NOTE

*This game has automatic detection of a coin mech failure whenever the power is applied. If you see a "+" symbol by the credits number on the screen, this means that the software detects a possibly bad coin mech. If the "+" is on the left side, the left coin mech may be bad (the right coin mech will also have 8x more credits than the left in the statistics screen). If the "+" is on the right side, the opposite is true.*



**Figure 2-1 Quick Self-Test Screen**

This quick self-test screen stays on until 60 seconds after you last press a button or move a control. Then the attract mode appears. You can also press two start buttons to exit this quick self-test.

Screen	Use or Purpose
Select Test	Use to select from the full list of available self-test screens.
Adjust Volume	Displays the game sound level adjustment.
Statistics	
Statistics Display	Displays the game statistics.
Histogram Display	Display a horizontal bar graph of game times.
Game Options	Use to set and check the game options settings.
Coin Options	Use to set and check the coin options settings.
Sound Board Test	Use to check the audio circuits and the coin switches.
Controls Test	Use to test the control panel switches and joysticks or whirly-gigs.
RAM Tests	
Video RAM (looping)	Use to check the video RAM.
Color RAM (looping)	Use to check the color RAM.
All RAM (looping)	Use to check all RAM.
ROM Test	Use to check the program ROMs.
Playfield Stamp Test	Use to check the alphanumeric and graphic displays.
Motion Object Test	Use to test the movement and color of game objects.
Monitor Tests	
Color Test	Use to check the video display color circuits.
Purity Test	
Red Color Purity	Use to check the red color purity in the video display.
Green Color Purity	Use to check the green color purity in the video display.
Blue Color Purity	Use to check the blue color purity in the video display.
White Color Purity	Use to check the white color in the video display.
Grey Color Purity	Use to check the grey color in the video display.
Convergence Test	
White Convergence	Use to check and adjust video display convergence of red, blue, and green.
Violet Convergence	Use to check and adjust video display convergence of red to blue.
Green Convergence	Use to check and adjust video display convergence of red and blue to green.

**Table 2-1 Summary of All Self-Test Screens**



## Entering and Exiting the Self-Test

To enter the complete self-test, turn on the self-test switch on the game PCB. Exit the self-test by switching off the self-test switch.

## Select Test Menu

Choose which test or screen you want to see from this menu, shown in Figure 2-2. Move up and down the list by moving the left control; the corresponding test is highlighted in white. Choose the screen by pressing either left-player start button. Pressing the right start button also lets you advance to the next item in the list.

## Adjust Volume

This game has digital volume control — not a potentiometer. The screen has 32 grey vertical bars that become filled with green as you increase volume. To raise the volume, move the left control. To forget any changes, push the right start button. To save this setting and return to the test menu, press the left start button. An average volume level is when the left half of the bars is filled with green.

### NOTE

*If you have installed optional volume adjustment switches, these switches will also change the volume level anytime during the attract mode or game play.*

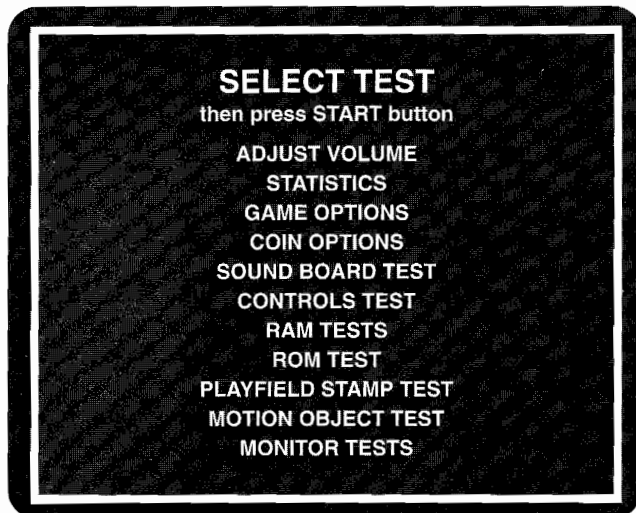


Figure 2-2 Select Test Screen

## Statistics

### Statistics Display

Use the information shown on the statistics screen, in Figure 2-3, and on the histogram screens to keep track of your game use and maximize your profits. Record the information on the Off the Wall statistics page in the back of this manual. The statistics are collected from the last time the statistics were cleared. Follow the instructions at the bottom of the screen to clear the statistic or to exit from this screen and go to the histogram.

- *Left Coins* show the number of coins counted in the left coin mechanism.
- *Right Coins* show the number of coins counted in the right coin mechanism.
- *Aux Coins* shows the number of coins counted on the auxiliary service coin inputs.

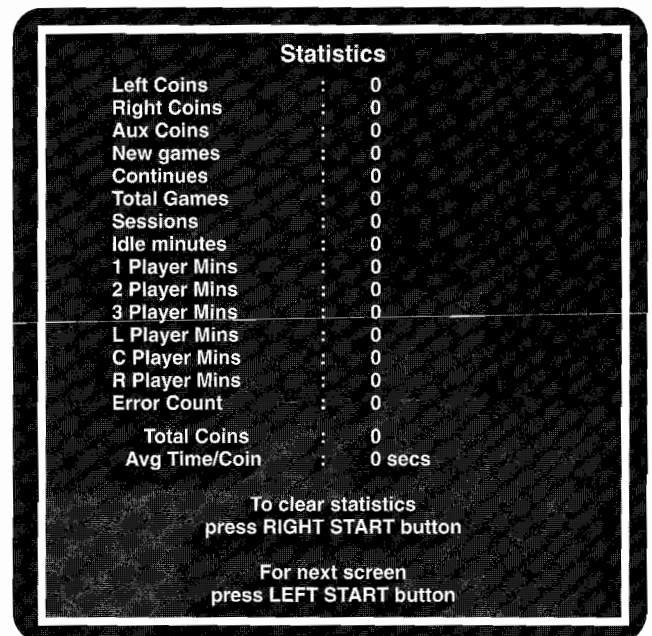
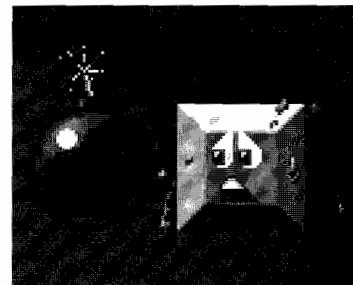


Figure 2-3 Statistics Screen



Option	Settings		Explanation
Restore Factory Options	Yes	No ✓	Lets you set all the game options to the factory options or lets you use your own settings. Make sure you set this to "no" to use your own chosen settings.
Game Difficulty	Easy Hard	Moderate ✓ Very Hard	Starting ball speed and maximum ball speed determine the game difficulty.
Number of Players Allowed	Two ✓	Three	Lets you set the software to correspond with how many player stations are installed on the control panel.
Music in Attract (Mode)	Yes ✓	No	Lets you turn the sound on or off in the attract mode. Note that if set to "On", the music <i>only</i> turns on for about 30 seconds every 10 minutes—not constantly.
Clear High Score Table	Yes	No ✓	Lets you clear the high score table.
Auto High-Score-Table Reset	Yes ✓	No	Automatically resets the high scores to the factory defaults after 2000 games, unless any players have entered their initials within the previous 200 games.

✓ *Manufacturer's recommended settings. These settings are shown in green on the screen.*

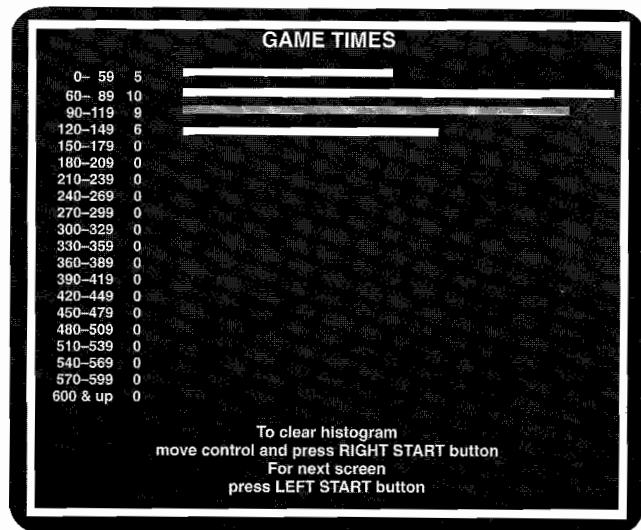
**Table 2-2 Game Option Settings**

- *New Games* is the number of games played *before* continuation.
- *Continues* is the number of games played during "add-a-coin" (continuation).
- *Total Games* is the number of games played (one game per player).
- *Sessions* is the number of sessions played. For example, one 2-player game counts as one session.
- *Idle Mins* shows the number of minutes the game was not being played.
- *1-Player/2-Player/3-Player Mins* are the number of minutes the game was played by one player alone, two players simultaneously, or three players simultaneously.
- *Left/Center/Right Player Mins* are the number of minutes the game was played at the left, center (if installed), and right player stations.
- *Error Count* shows the number of errors counted in the erasable memory. If you have an error count, the statistics may be wrong. If you consistently have errors counted for several weeks, replace the EEROM at 19L on the game PCB.
- *Avg Time/Coin* is the average number of seconds played per coin.

Press the left start button to see the histogram screen.

### Histogram Display

The histogram (horizontal bar graph) screen is shown in Figure 2-4; it displays the game times in seconds. Use it to keep track of your game use and to maximize your profits. The red highlighted time span is the median value (the midpoint), meaning half the games were below this value and half were above. Follow the instructions at the bottom of the screen to clear the histogram or to exit from this screen and return to the select test screen.



**Figure 2-4 Histogram Screen**

Option	Settings	Explanation
Free Play	No <input checked="" type="checkbox"/> Yes	Set this to "Yes" for demonstrating the game.
Discount to Continue	No <input checked="" type="checkbox"/> Yes	Lets you offer a reduced price per credit when players want to continue a game.
Game Cost	1 coin 1 credit <input checked="" type="checkbox"/> 2 coins 1 credit ... 8 coins 1 credit	Sets the number of coins required for one credit.
Bonus for Quantity Buy-in	None <input checked="" type="checkbox"/> 2 coins give 1 (extra coin) ... 9 coins give 3 (extra coins)	Lets you choose various levels of bonus coins or no bonus.
Right Mech Value	1 coin counts as 1 coin <input checked="" type="checkbox"/> ... 1 coin counts as 8 coins	Is the number of coins each coin counts as in the right coin mechanism.
Left Mech Value	1 coin counts as 1 coin <input checked="" type="checkbox"/> ... 1 coin counts as 8 coins	Is the number of coins each coin counts as in the left coin mechanism.

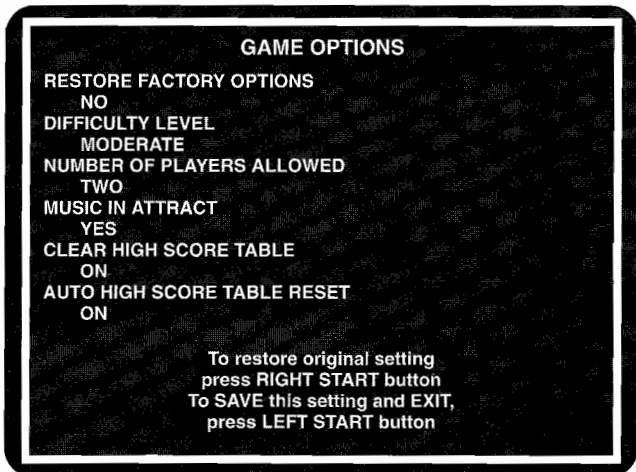
Manufacturer's recommended settings. These settings are shown in green on the screen.

**Table 2-3 Coin Option Settings**

## Game Options

Check and select the coin options on this screen, shown in Figure 2-5.

To move through the options, move the left control. Change the option highlighted in blue. The factory default settings are shown in green. To change a setting, move the control. Follow the instructions at the bottom of the screen to restore the original settings or save revised settings. Press the left start button to exit.



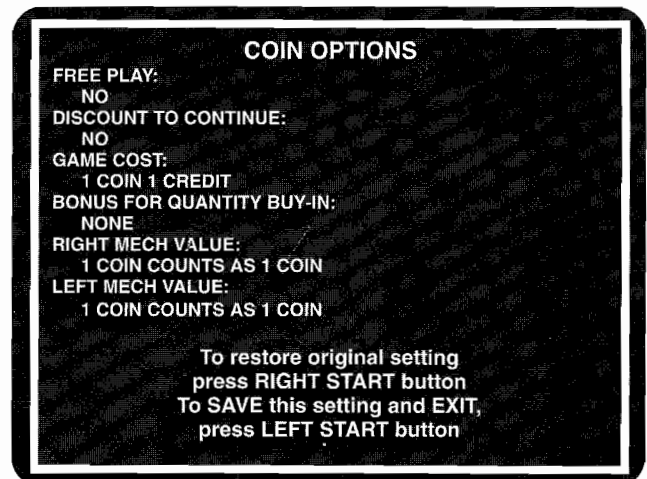
**Figure 2-5 Game Options Screen**

The game option settings with factory defaults are shown in Table 2-2.

## Coin Options

Check and select the coin options on this screen, shown in Figure 2-6.

To move through the options, move the left control. Change the option highlighted in blue. The factory default settings are shown in green. To change a setting, move the right control. Follow the instructions at the



**Figure 2-6 Coin Options Screen**

bottom of the screen to restore the original settings or save revised settings. Press the left start button to exit.

The coin option settings and factory defaults are explained in Table 2-3.

## Sound Board Test

The sound board test indicates the condition of the sound effects circuit on the JSA Audio III PCB. You can also test the coin switches in this screen. This test appears in Figure 2-7. Press any two start buttons to return to the select test menu.

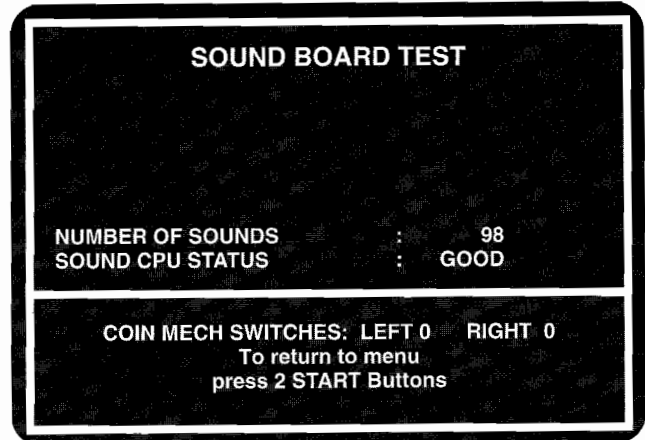
## Controls Test

The controls test screen is shown in Figure 2-8. You can test all the control panel switches and joysticks or whirly-gigs.

If you have joysticks, your display will look like the left screen in Figure 2-8. As you press each button, the grey switch name changes to white. The joystick switch markers (small grey asterisks) move in the same direction as the joystick. A red *ERROR* message means two opposing switches are simultaneously activated. If the asterisks do not appear correctly or you see the *ERROR* message, check the connections, switches, and joystick control.

If you have whirly-gigs instead of joysticks, your display will look like the right screen in Figure 2-8. As you turn the whirly-gig clockwise, the "raw" reading should increase and the "delta" reading should be a positive number. As you turn it counter-clockwise, the raw reading should decrease and the delta reading should be a negative number.

Simultaneously press two start buttons to return to the select test screen. When you first enter self-test the joy-



**Figure 2-7 Sound Board Test Screen**

sticks control screen will be displayed. Whirly-gigs are detected automatically when they are used.

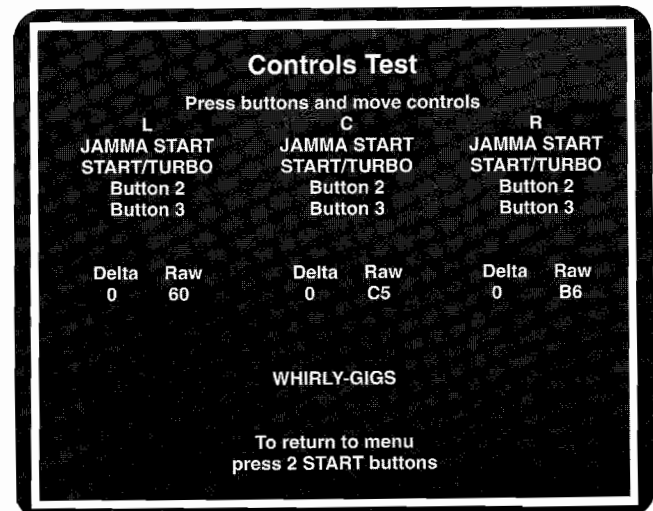
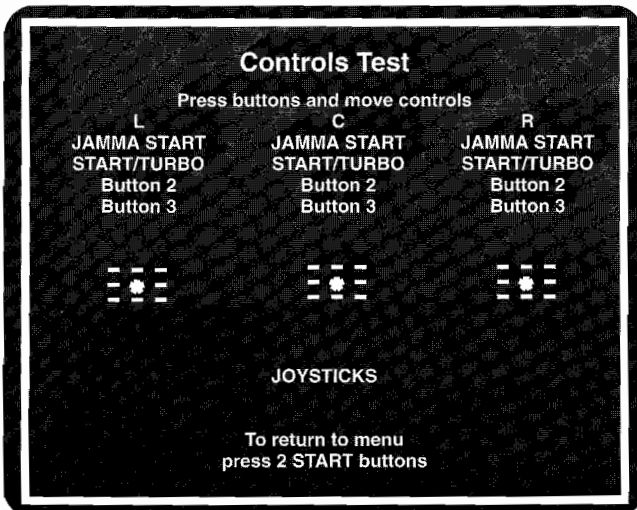
## RAM Tests

Use this selection screen, shown in Figure 2-9, to choose which RAM test you want to perform. Use the different tests according to Table 2-4. If you have serious RAM problems, you may see only a colored screen.

Press the left start button (and hold it, if the test is looping) to leave the individual RAM test and return to the Select RAM Test screen. Press the left start button once more to return to the select test screen.

## ROM Test

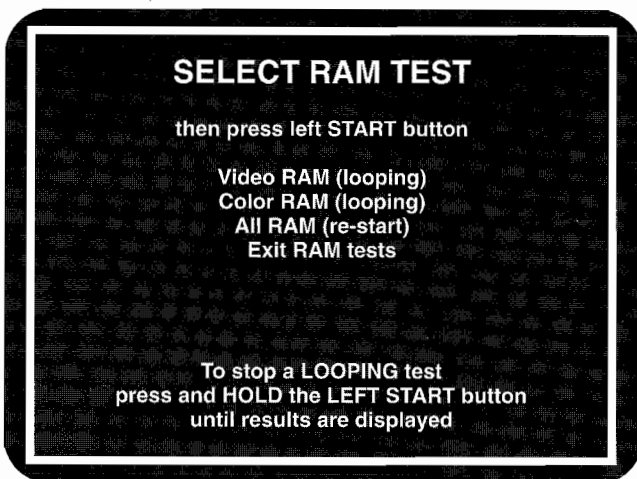
The ROM test screen is shown in Figure 2-10. The checksum information appears. If the game has no ROM errors, you see the message *ALL ROMS are OK*.



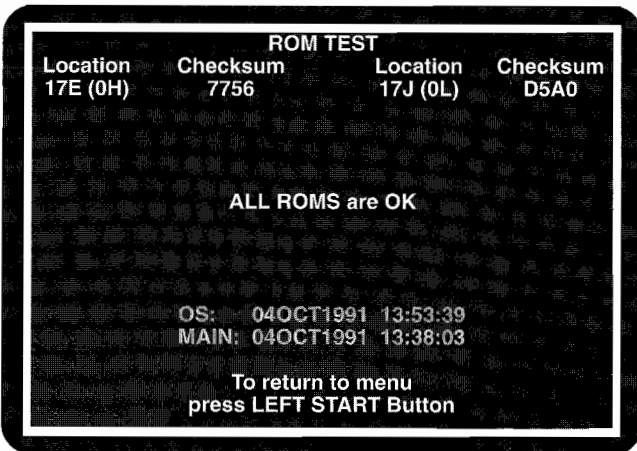
**Figure 2-8 Controls (Joysticks/Whirly-Gigs) Test Screen**

Problem	Type of Test	Location of RAMs Tested
Playfield is erratic or looks wrong, motion objects are not working properly, or game play is erratic or game is locked up.	Video RAM	7K, 9K
Colors look wrong.	Color RAM	3E, 6E

**Table 2-4 When to Run the RAM Tests**



**Figure 2-9 RAM Tests Menu**



**Figure 2-10 ROM Test Screen**

If the game does have ROM errors, the location of the bad ROM(s) will be displayed. *Note: the OS (operating system) and program dates in your game will be different from those shown in Figure 2-10.*

Press the left start button again to return to the select test screen.

## Playfield Stamp Test

This test, shown in Figure 2-11, checks the condition of the playfield graphics ROMs in the game. Scroll through the stamps with the left control. If you see an error on the screen or large numbers of stamps missing, this indicates an error with the playfield ROMs located at 14P, 18P, 14S, 18S. Press the left start button to go to the select test screen.

## Motion Object Test

This test, shown in Figure 2-12, checks the transparency, movement, and color of various objects in the game.

Select the test function with the right start button. Use the joystick or whirly-gig to move objects, change pictures, change object size, change object palette, and toggle the horizontal flip. If there is an error, check the motion object ROMs at 14P, 18P, 14M, and 18M.

Simultaneously press any two start buttons to go to the select test screen.

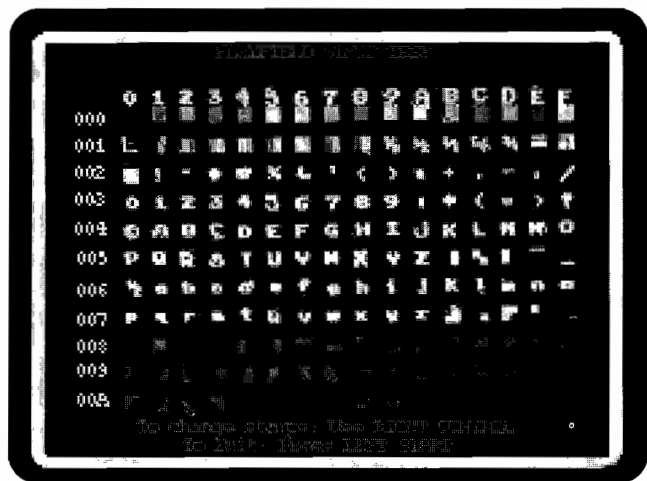
## Monitor Tests

These tests indicate the accuracy of three types of monitor adjustments. You select the test from the monitor test selection menu.

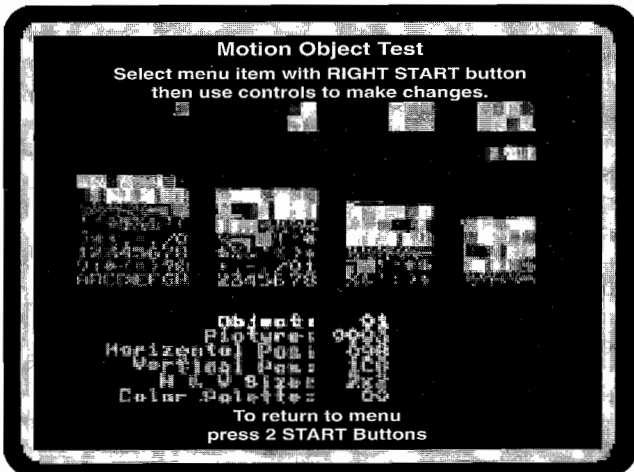
### Color Test

This test shows the dynamic range of the video display color circuit. The screen is shown in Figure 2-13.

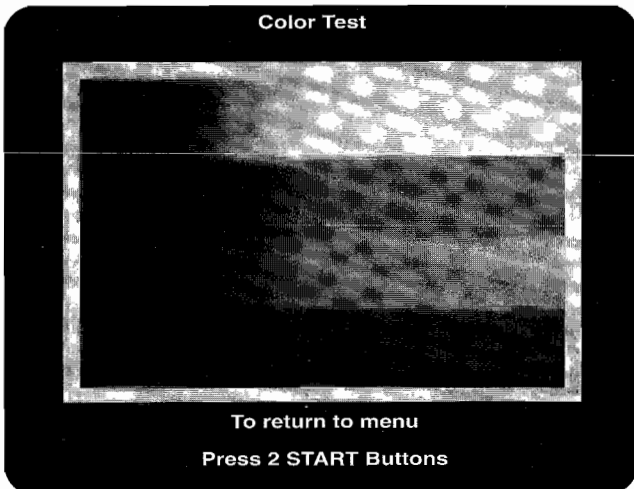
The screen should be four bands (black/white, red, green, and blue from top to bottom), each with a color scale from dark to bright, left to right. If the screen



**Figure 2-11 Playfield Stamp Test Screen**



**Figure 2-12 Motion Object Test Screen**



**Figure 2-13 Color Test Screen**

does not match this description, adjust the video display as described in the video display manual.

Pressing the left start button causes 32 or 64 steps for each color band to be displayed. In addition, pressing the right start button causes the white border to be turned on or off.

Return to the select monitor test screen by pressing any two start buttons.

**Color Purity Test**

The color purity test has five screens. Each screen is a solid rectangle of color. The first screen is red. The

other screens, which you can see by pressing the right start button, are green, blue, white, and grey.

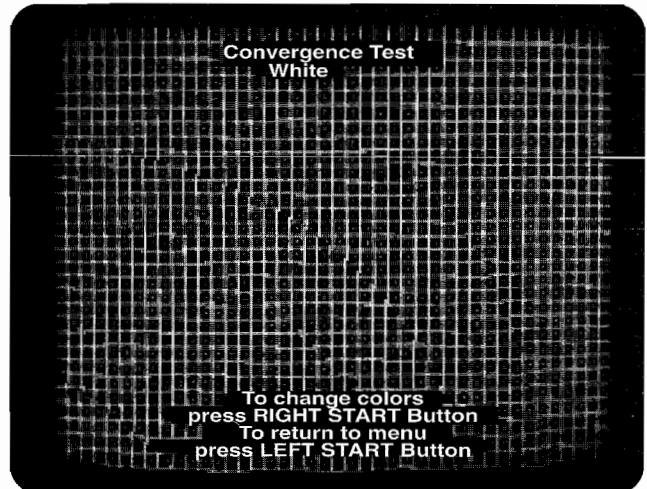
These screens show the adjustment of the color purity of the video display. Each screen should display a rectangle of color, with no curving at the corners, no unevenness of color, and no lines in the display.

If the screens are not correct, adjust the video display as described in the video display manual.

Return to the select monitor test screen by pressing the left start button.

**Convergence Test**

The convergence test has three screens: first white, then violet, and finally green. The white screen is shown in Figure 2-14. To see the violet and green screens, press the right start button. Press the left start button to go to the select monitor test screen.



**Figure 2-14 Convergence Test Screen**

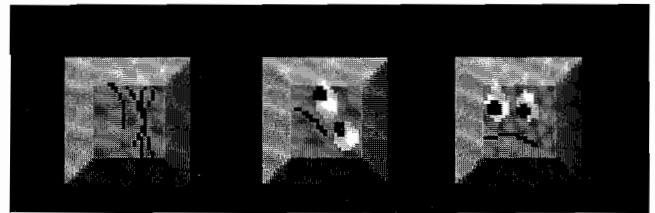
Check the following on the screens:

- The grid lines should be straight within 3 mm, and the lines should not pincushion or barrel.
- The convergence of the lines on the violet and white screens should be within 2 mm.

If these screens do not meet these criteria, adjust the video display as described in the video display manual. Return to the select monitor test screen by pressing the left start button.



# Troubleshooting and Maintenance



## INTRODUCTION

This chapter contains troubleshooting tables and repair procedures for your Off the Wall™ game. The chapter has two parts. The first part contains three troubleshooting tables. The tables contain general troubleshooting information, the voltage levels and test points on the printed-circuit boards, and a list of ROM-caused problems, with specific ROMs to check and replace. ❖ The last part of the chapter has information about connecting the video display (if it requires separate positive sync) and repair information for the joystick and whirly-gig controls.

<b>Problem</b>	<b>Suggested Action</b>
<b>Coin Mechanism Problem</b>	<ol style="list-style-type: none"> <li>1. Check the wiring to the coin switch and counter.</li> <li>2. Test the coin switch with the sound test screen in the self-test.</li> </ol>
<b>Game Play Problem</b>	<ol style="list-style-type: none"> <li>1. Check the harness and connectors.</li> <li>2. Perform the self-test.</li> <li>3. Check the voltage levels on the PCB. See Table 3-2, <i>Voltage Inputs and Test Points</i>.</li> <li>4. Check <i>What ROM Problems Look Like</i>, Table 3-3, for specific ROM problems.</li> </ol>
<b>Joystick/Whirly-Gig Problems</b>	<ol style="list-style-type: none"> <li>1. Has the joystick been lubricated? If not, lubricate it at the location shown in Figure 4-2.</li> <li>2. Check the harnesses and connectors.</li> <li>3. Check the switches on the joystick or the encoder pot on the whirly-gig control by using the Controls Test in the self-test procedure.</li> <li>4. If you took the control apart, have you reassembled it correctly?</li> <li>5. Make sure all the parts on the control are in good repair. Repair or replace parts.</li> </ol>
<b>Sound Problem</b>	<ol style="list-style-type: none"> <li>1. Is the speaker volume turned up? (Volume is adjusted digitally in the self-test.)</li> <li>2. Check the voltage on the game PCB edge connector.</li> <li>3. Check the wiring from the PCB to the speaker.</li> <li>4. Check the voltage level to the PCB. See Table 3-2, <i>Voltage Inputs and Test Points</i>.</li> <li>5. Replace the speaker.</li> </ol>
<b>Video Display Problem</b> Screen is dark.	<ol style="list-style-type: none"> <li>1. Is the game plugged in?</li> <li>2. Is the game turned on?</li> <li>3. Are the connections good?</li> <li>4. Is the line fuse good?</li> <li>5. Is the display brightness turned up?</li> <li>6. Are the solder connections on the line filter and transformer good?</li> <li>7. Is the game PCB edge connector tightly connected?</li> <li>8. Check all of the items below. If you answer <i>no</i> to any question, you have a problem with the video display, not with the game circuitry. See your video display service manual. <ol style="list-style-type: none"> <li>a. Do you have power to the video display?</li> <li>b. Are the video display's filaments lit?</li> <li>c. Do you have high voltage to the video display?</li> </ol> </li> <li>9. Are the voltage levels to the video display PCB correct? (Power voltage is 100 VAC or 110 VAC, depending on the type of video display. Video signal voltage is 0.5 to 3.5 Volts.)</li> <li>10. If the level is not correct, check the connectors and the harness.</li> </ol>
Only a colored screen appears.	You probably have a serious RAM problem.
Display area wavers or is too small.	<ol style="list-style-type: none"> <li>1. Do you have correct power voltage to the video display PCB?</li> <li>2. Do you have correct high voltage to the video display?</li> </ol>
Picture is wavy.	<ol style="list-style-type: none"> <li>1. Is the monitor ground connected to the monitor?</li> <li>2. Are the sync inputs connected properly?</li> </ol>
Picture is upside down.	When you serviced the display, you connected the wires incorrectly. Switch the horizontal or vertical yoke wires on the display.
Convergence, purity or color problems.	Use the screens in the self-test to adjust the video display. Use the adjustment procedures in your video display manual.
Picture is not centered.	Use the centering procedures in your video display manual.

**Table 3-1 Troubleshooting Table**



Voltage	Test Point or LED	Source and Purpose
+5 ± 0.25 VDC	+5V1	Logic power from the switching power supply.
	CR5 LED (Game PCB)	Lights when 5 V is applied to the PCB and the reset (RST) jumper is open.
	CR9 LED (JSA Audio III PCB)	Lights when the +12 V supply is good.
	CR3 LED (JSA Audio III PCB)	Lights when the -5 V supply is good.

**Table 3-2 Voltage Inputs and Test Points on the PCBs**

Problem	ROM Causing the Problem	Check the ROM at:
Program works, but motion objects or playfield is wrong.	Graphics ROMs	High: 18M, 18P, 18S (Game PCB) Low: 14M, 14P, 14S (Game PCB)
Garbage on screen; program doesn't work.	Processor	13F (Game PCB)
Game program is erratic.	Program ROMs	High: 17E. Low: 17J (Game PCB)
No sound or erratic sound	Audio Program	12C (JSA Audio III PCB)

**Table 3-3 What ROM Problems Look Like**

## Video Display Sync Problems

This game board provides separate positive horizontal and vertical sync on a separate connector, for monitors that will not work with the composite negative sync signal provided at the JAMMA edge connector.

This connector (labeled "Sync") is located near the edge connector. Pin 1 is horizontal sync, Pin 2 is vertical sync, and Pin 3 is ground.

## Troubleshooting

The tables in this chapter (3-1, 3-2, and 3-3) can help you troubleshoot problems in your game. The troubleshooting table lists possible sources of problems in various parts of the game. The voltage inputs and test points can help you troubleshoot PCB problems: The ROM problems table can help determine exactly which ROM might be causing game play problems.

## Removing and Replacing the Joystick Control

The joystick control is shown in Figure 4-2. If you want to repair the joystick control, disassemble it by removing it from the control panel. To repair the joystick, disassemble it by removing the retaining ring at the bottom of the shaft. To replace any of the four

switches, remove the two screws that secure each switch.

## Removing and Replacing the Whirly-Gig Control

The whirly-gig (encoder pot) control is shown in Figure 4-3. If you want to repair the whirly-gig control, disassemble it by removing the flanged knob from the control panel. Then remove the fastening hardware. To repair the whirly-gig, disassemble it by removing the split lock washer, nut, and washer from the top of the plate.



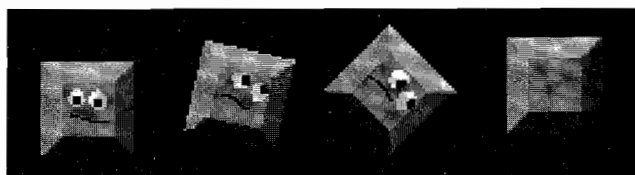
## ROMs and RAMs

If you think you have bad ROMs or RAMs, perform the ROM test in the self-test. If you have a ROM problem, see Table 3-3.



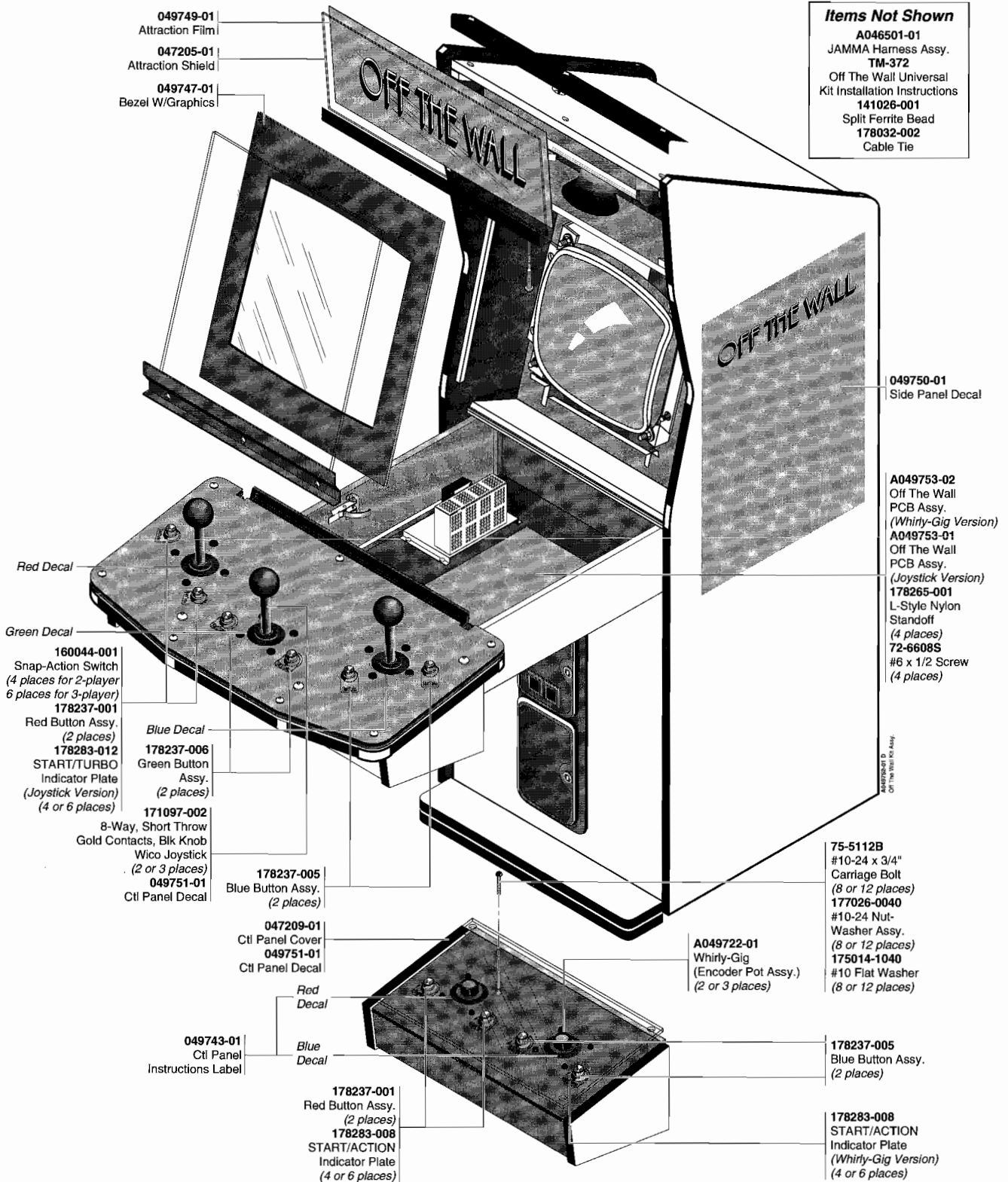
# NOTES

# Parts Illustrations

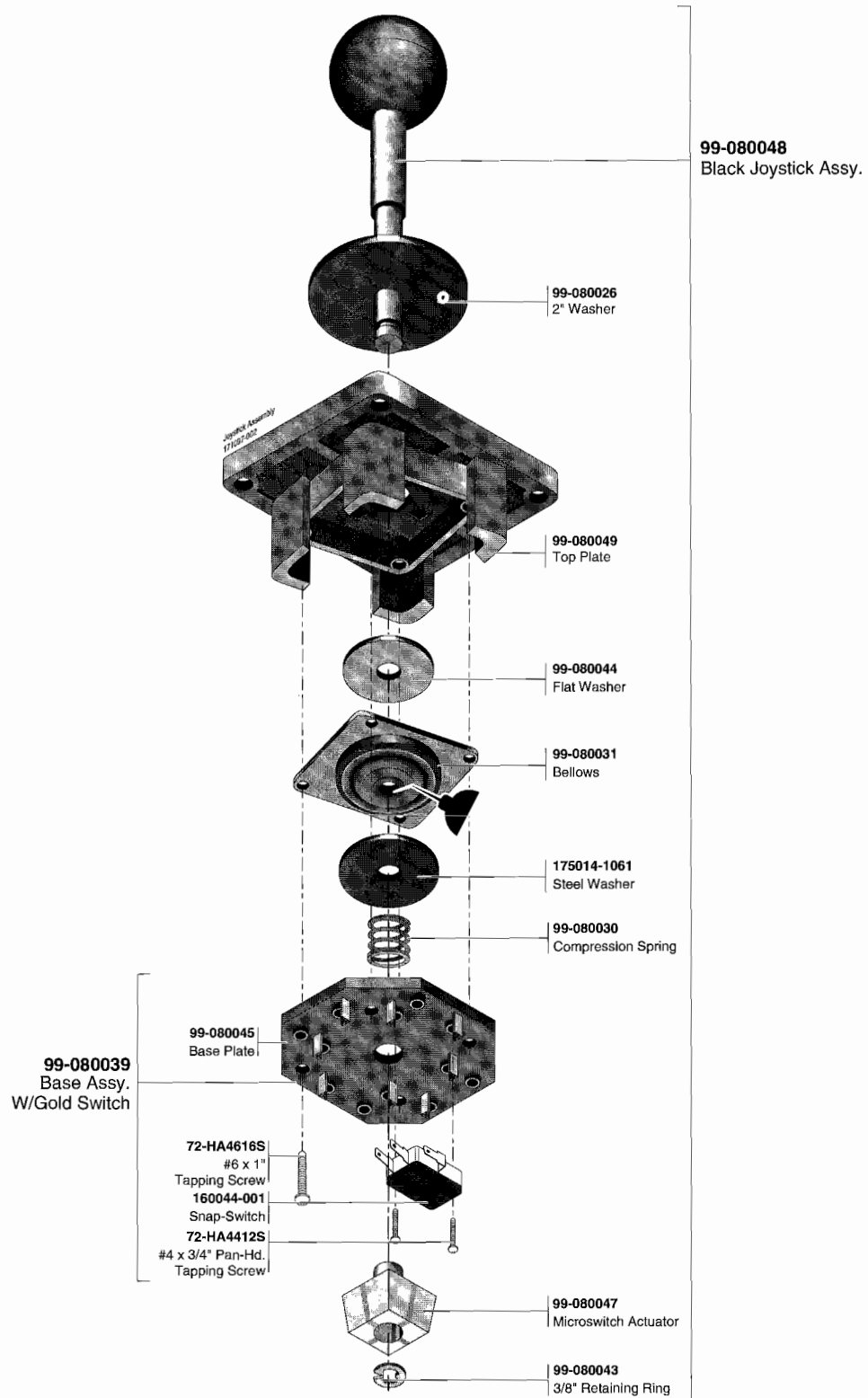


## INTRODUCTION

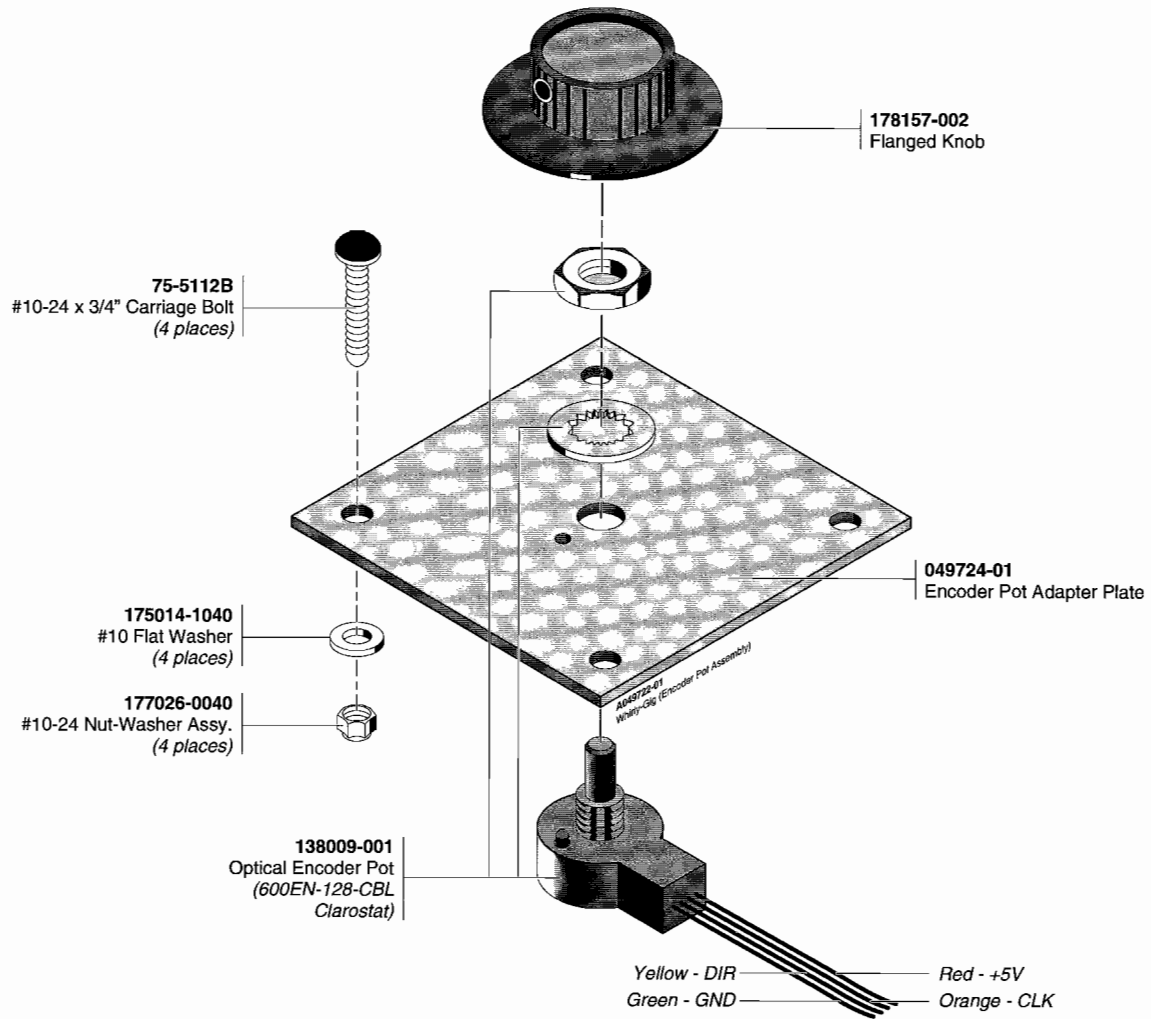
This chapter provides information you need to order replacement parts for your kit. Common hardware parts, such as screws, nuts, washers, and so on, are included in these parts illustrations. When you order parts, give the part number, part name, the number of this manual, and the serial number of your game. ❖ With this information, we can fill your order rapidly and correctly. We hope this will create less downtime and more profit from your games. Atari Games Customer Service phone numbers are listed on the inside front cover of this manual.



**Figure 4-1** Parts for Off the Wall Universal Kit with Whirly-Gig Controls (A049752-02 D) and with Joystick Controls (A049752-01 D)

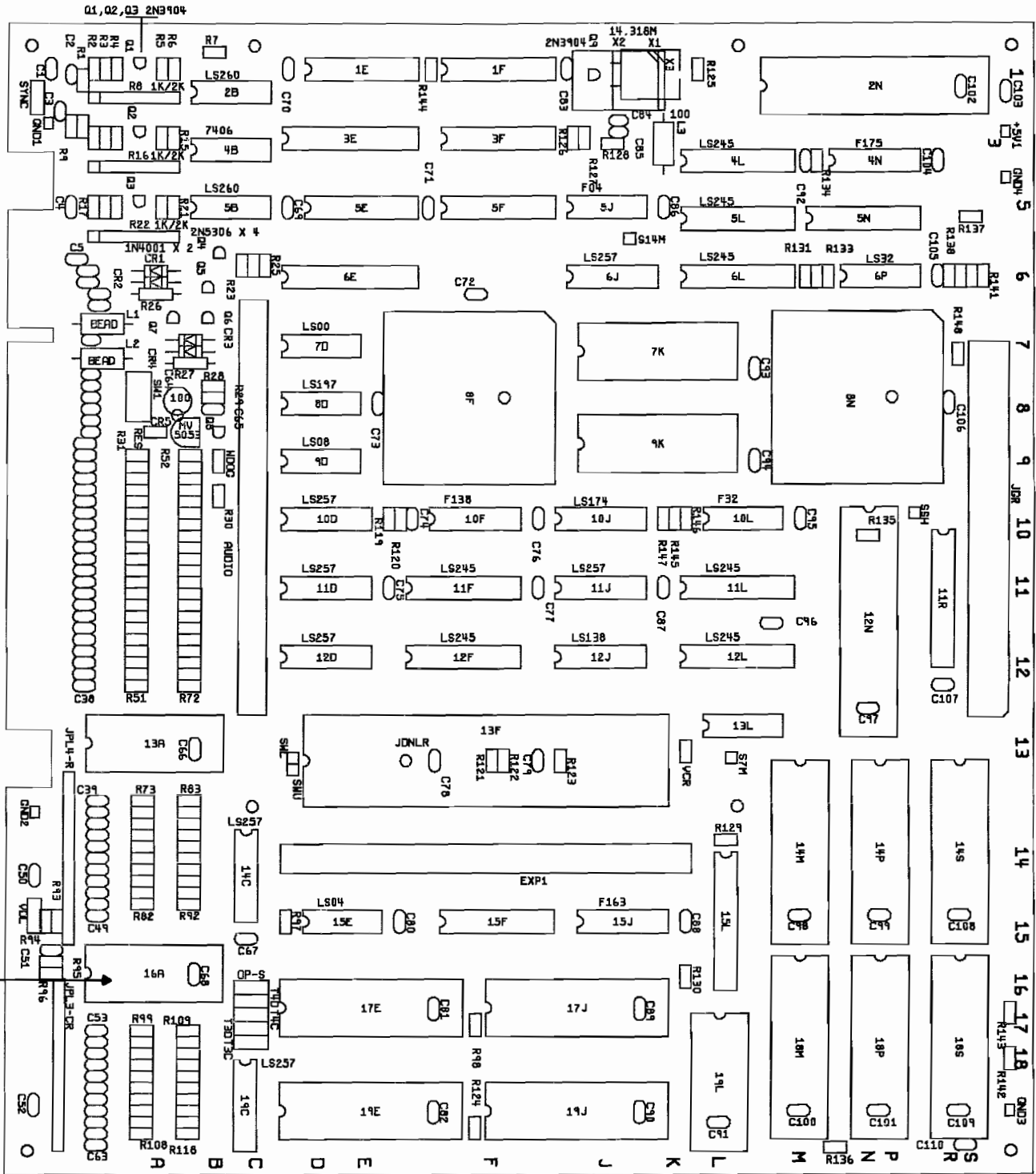


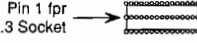
**Figure 4-2 Wico 8-Way Short-Throw Joystick Assembly  
171097-002**



**Figure 4-3 Whirly-Gig (Encoder Pot) Assembly  
A049722-01 A**

NOTE: The IETA chip (part No. 137504-2002) on the Game PCB is ONLY being used with the Whirly-Gig Version of the game (A049727-02 A).



- NOTES:**
1. Note position of Pin 1 when inserting sockets for locations 7K and 9K.  

  2. 20 Pin device located at 11R is to be inserted using Pin 1 of 24 Pin sockets.
  3. Jumpers blocks OP-S, to have cap between 2 & 3.  
 T3C & T3D to have caps between 1 & 2 for player 3, Whirly-Gig (Encoder Pot).

**Figure 4-4 Off the Wall Game PCB Assembly with Whirly-Gig Controls (A049727-02 A) and with Joystick Controls (A049727-01 B)**

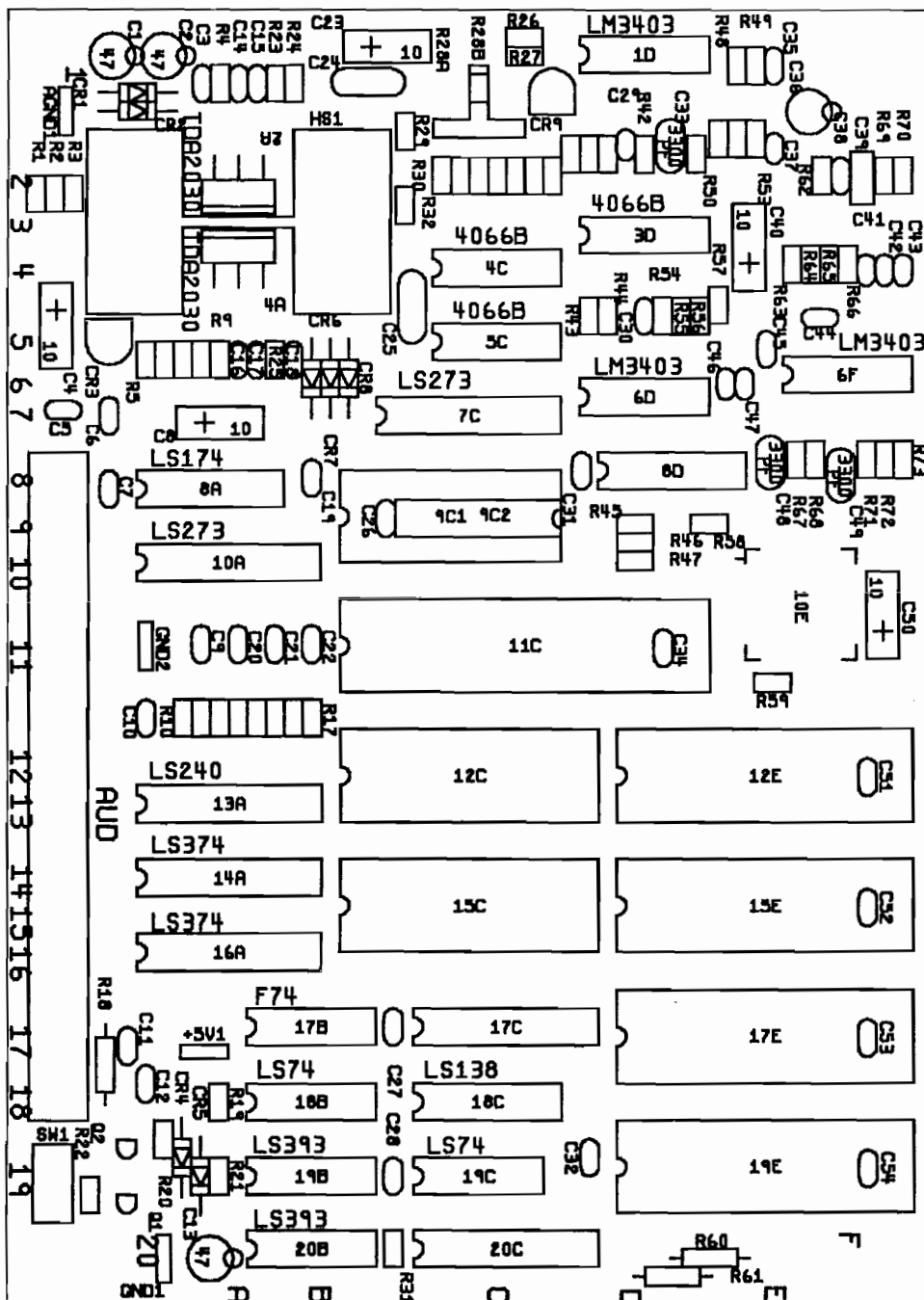


Figure 4-5 JSA (JAMMA Stand-alone Audio) III PCB Assembly  
A048974-07 A

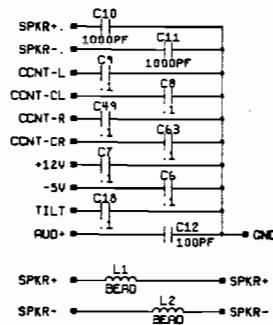
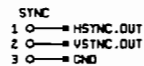
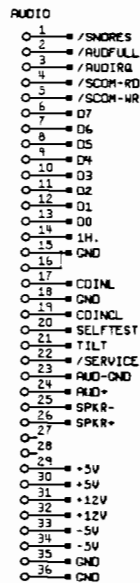
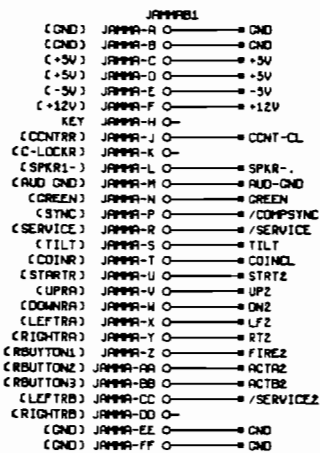
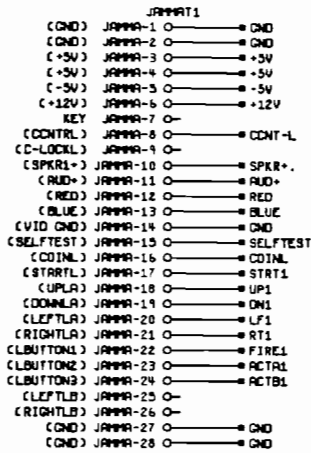


# Schematic Diagrams



## INTRODUCTION

This chapter contains the schematic diagrams for your Off the Wall™ game PCB and audio PCB. The game PCB and JSA Audio III PCB *assembly drawings* are illustrated in Chapter 4, Parts Illustrations.



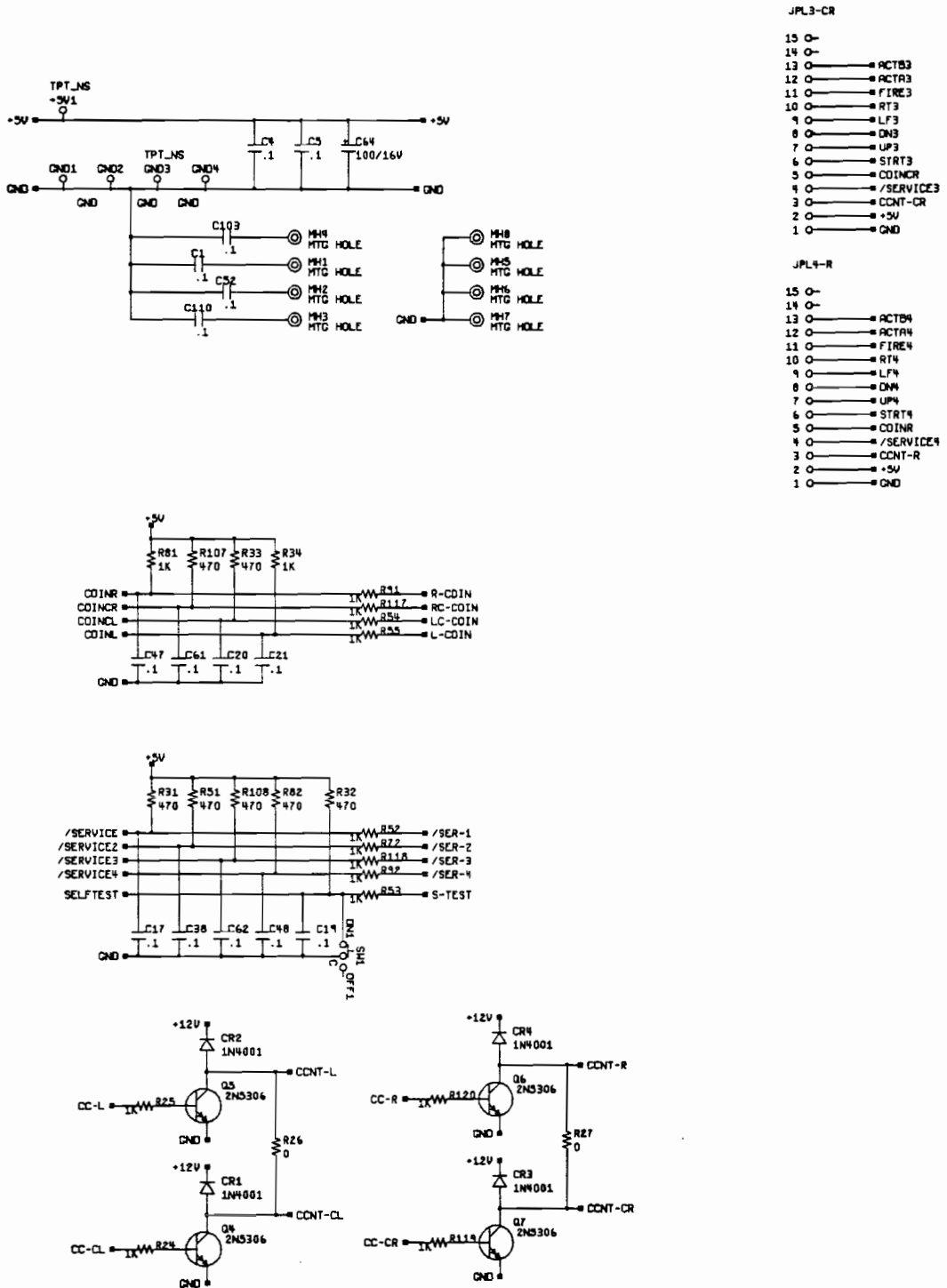
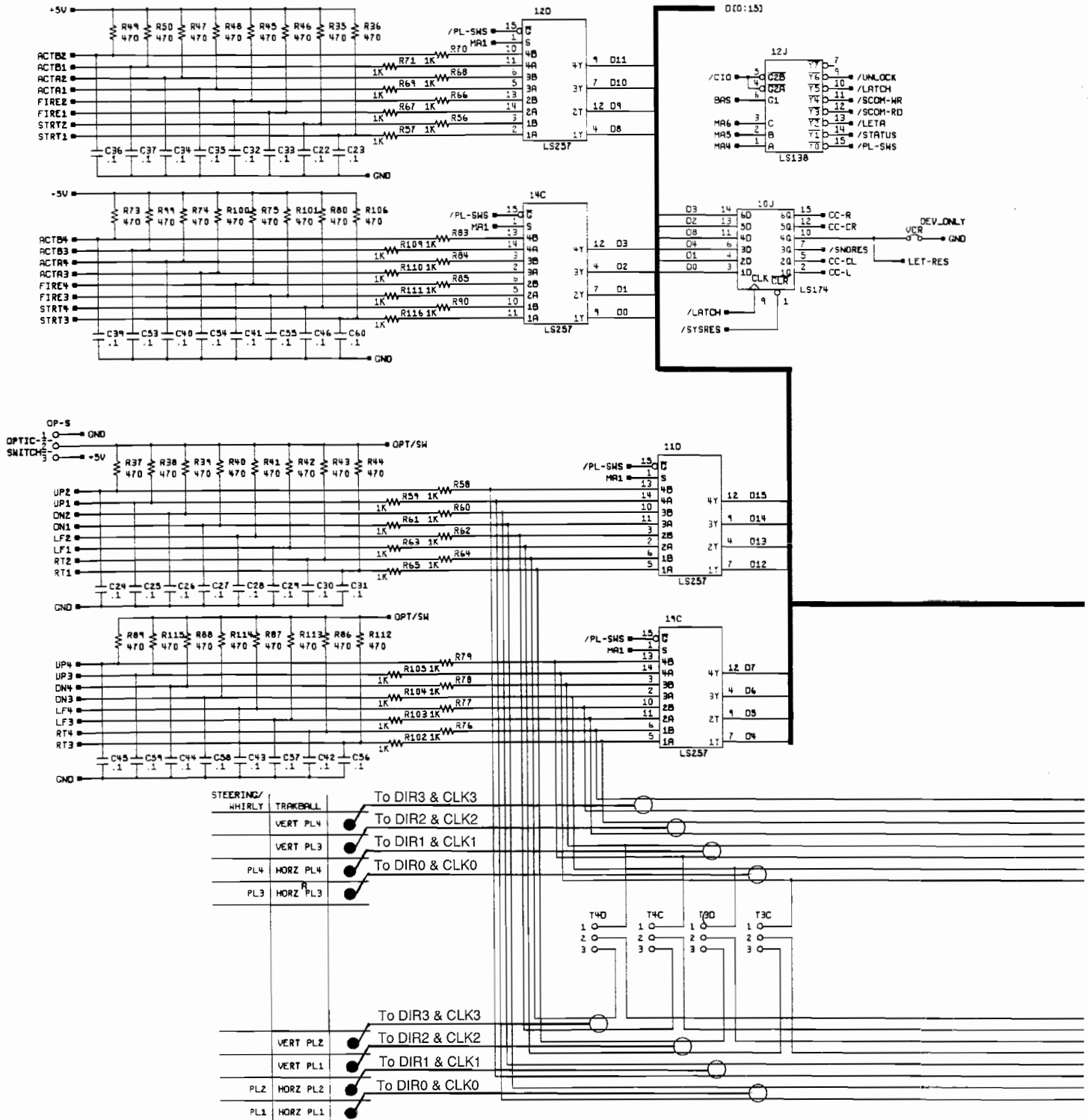


Figure 5-1 Off the Wall Game PCB Assembly Schematic Diagram

049726-01 B



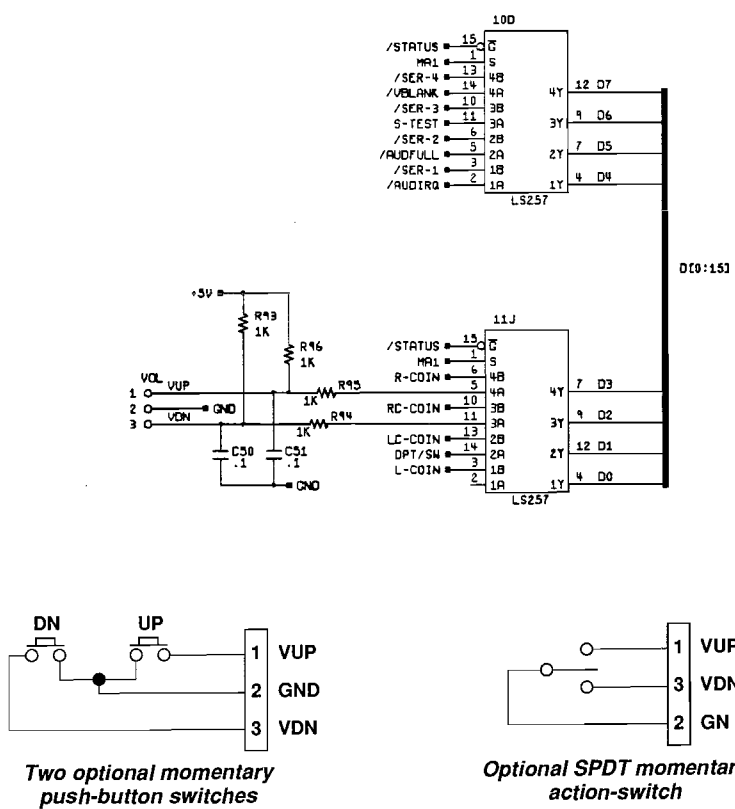
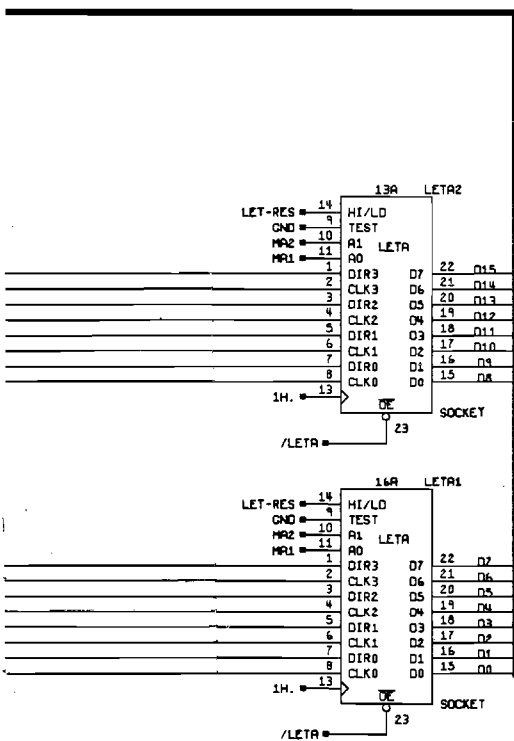
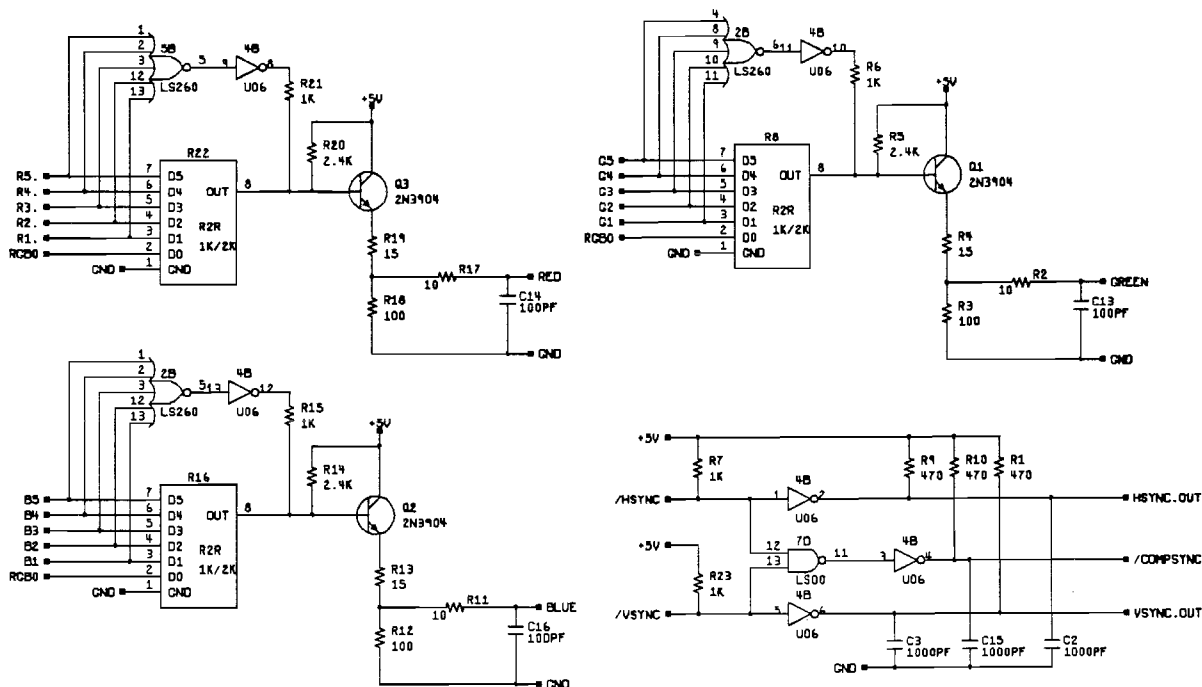
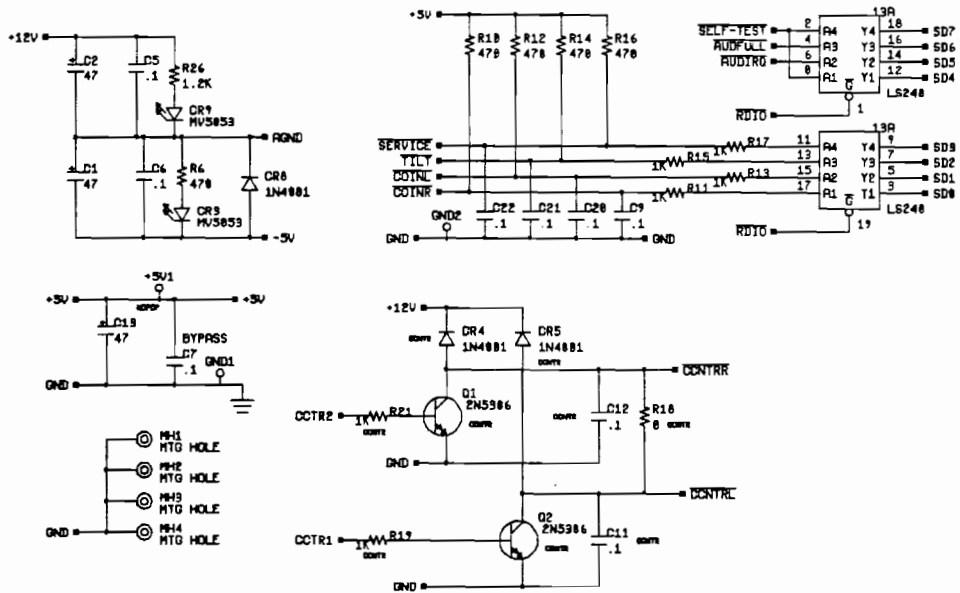


Figure 5-1 Off the Wall Game PCB Assembly Schematic Diagram

049726-01 B

- 1 → RESET
- 2 → AUDFULL
- 3 → AUDTRU
- 4 → AUDRD
- 5 → AUDRR
- 6 → D7
- 7 → D6
- 8 → D5
- 9 → D4
- 10 → D3
- 11 → D2
- 12 → D1
- 13 → D0
- 14 → 3579K
- 15 →
- 16 →
- 17 → COTNL
- 18 → GND
- 19 → COTNR
- 20 → SELFTEST
- 21 → YILY
- 22 → SERVICE
- 23 → AGND
- 24 → AUDOUT
- 25 → SPKR-
- 26 → SPKR+
- 27 → CENYRR
- 28 → CENYRL
- 29 → +5V
- 30 → +5V
- 31 → +5V
- 32 → +12V
- 33 → +12V
- 34 → -5V
- 35 → -5V
- 36 → GND



GND AND AGND TIED INTERNALLY NEAR MSM6295

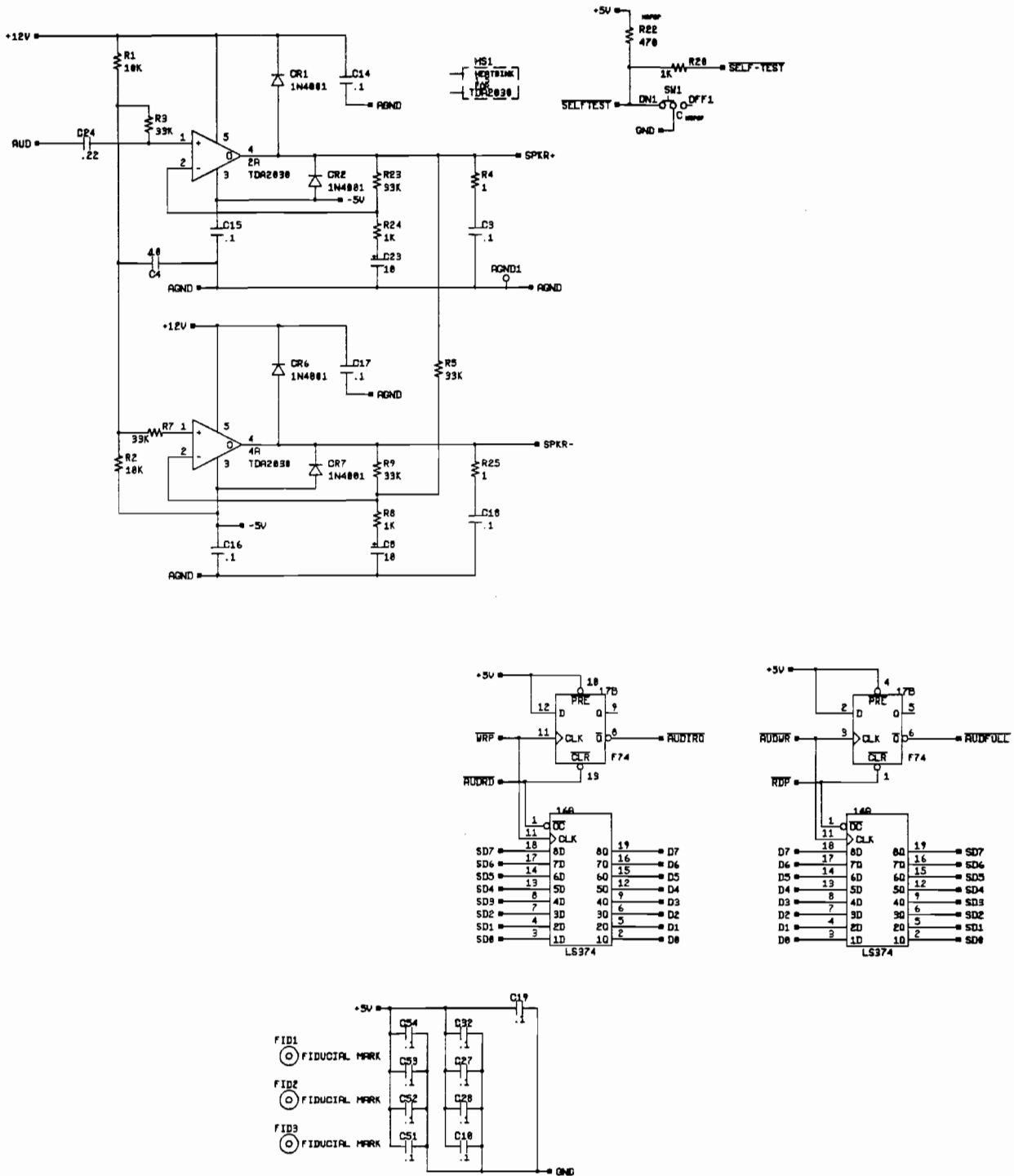
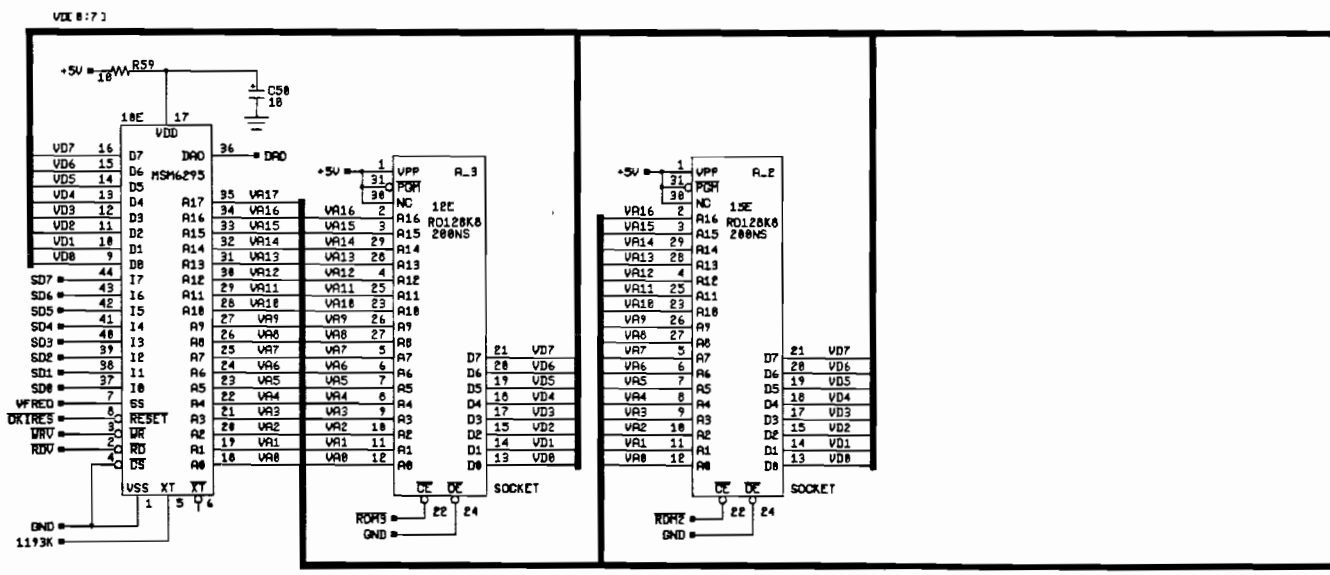
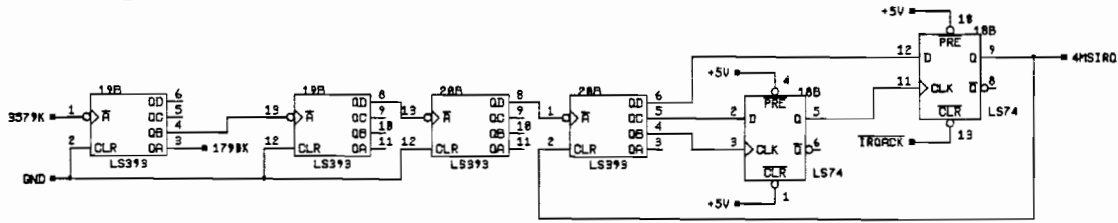
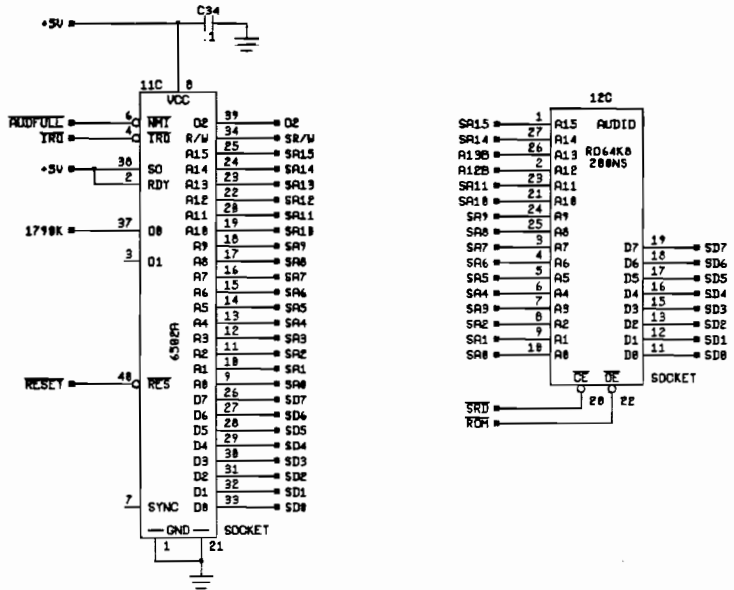


Figure 5-2 JSA Audio III Assembly Schematic Diagram

048973-01 C





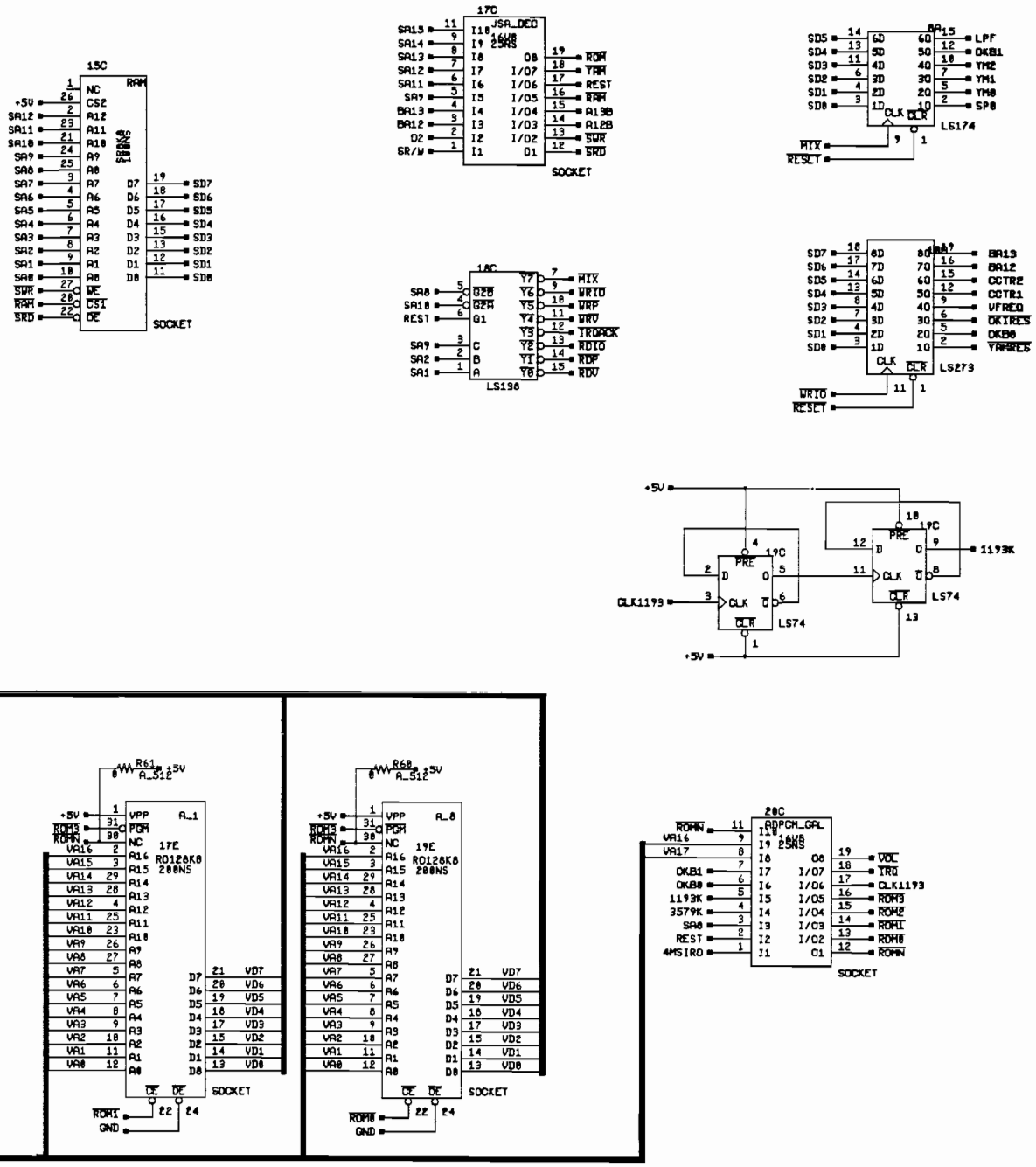
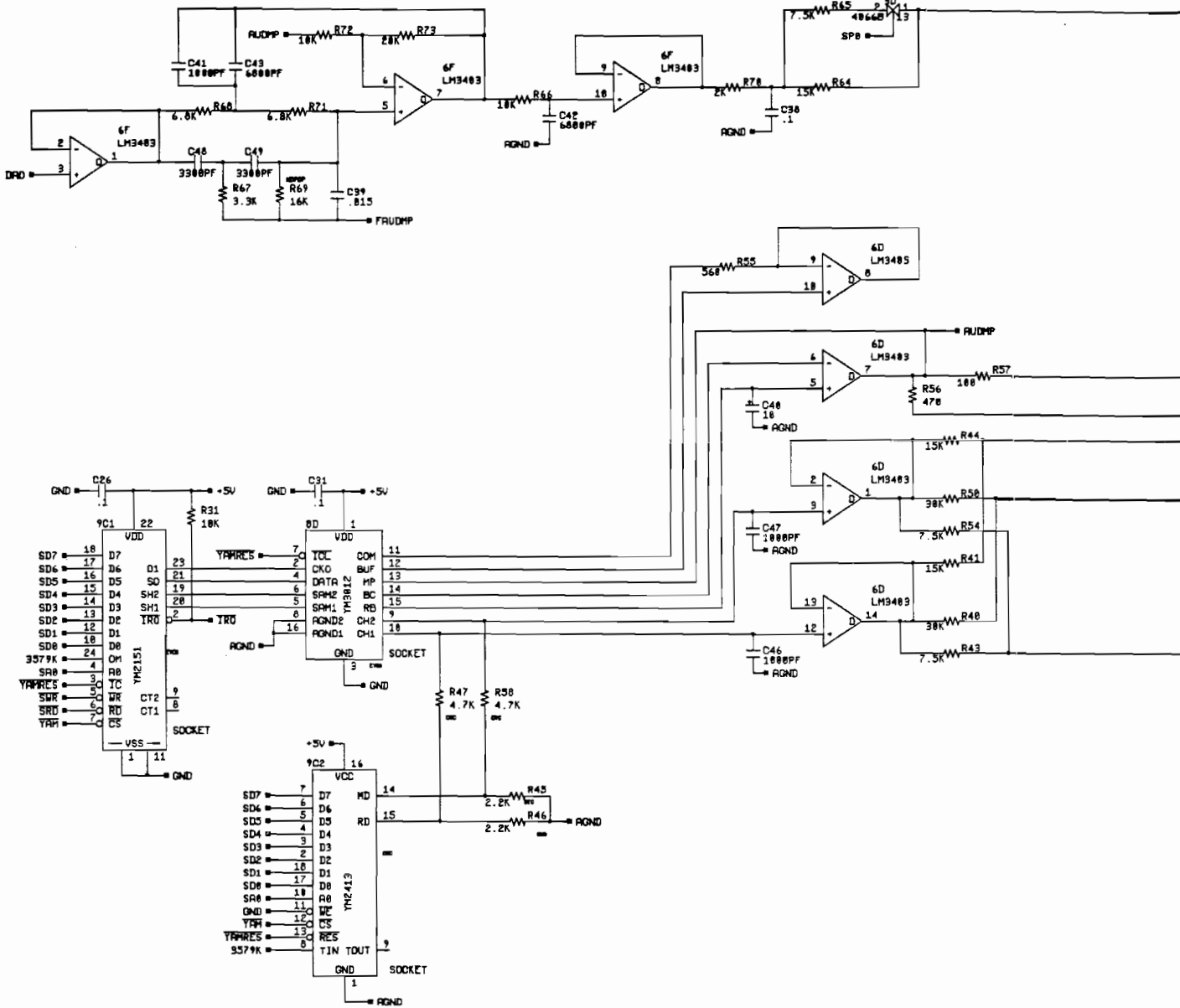


Figure 5-2 JSA Audio III Assembly Schematic Diagram

048973-01 C



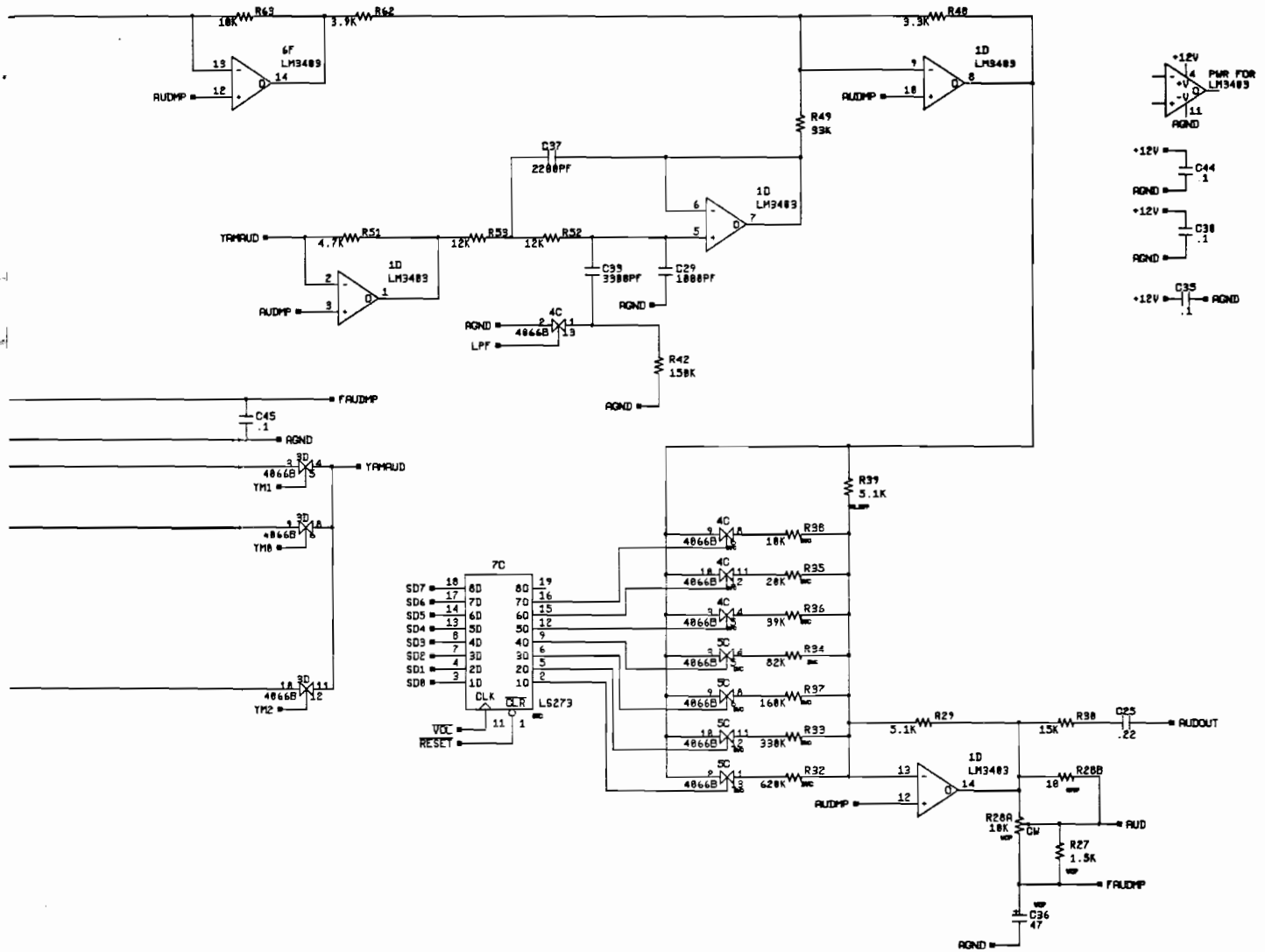


Figure 5-2 JSA Audio III Assembly Schematic Diagram

048973-01 C

**N O T E S**



# Off the Wall™ Statistics Sheet

Date Recorded: \_\_\_\_\_ Location: \_\_\_\_\_

Meter: \_\_\_\_\_

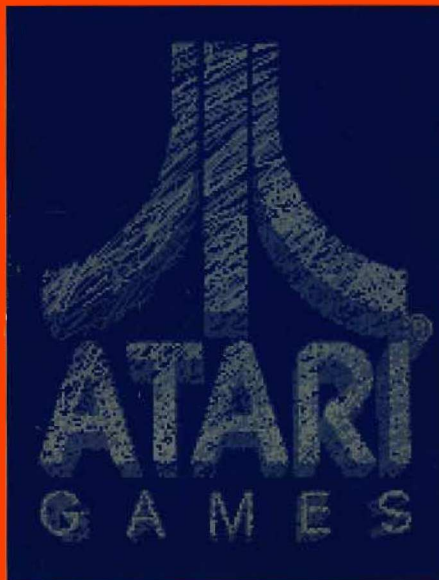
## *Statistics Screen*

Left Coins:	_____
Right Coins:	_____
Auxiliary Coins:	_____
New Games:	_____
Continues:	_____
Total Games:	_____
Sessions:	_____
Idle Minutes:	_____
1-Player Minutes:	_____
2-Player Minutes:	_____
3-Player Minutes:	_____
Left-Player Minutes:	_____
Center-Player Minutes:	_____
Right-Player Minutes:	_____
Error Count:	_____
Total Coins:	_____
Average Time/Coin:	_____ sec.









**Atari Games Corporation**

675 Sycamore Drive

P.O. Box 361110

Milpitas, CA 95036