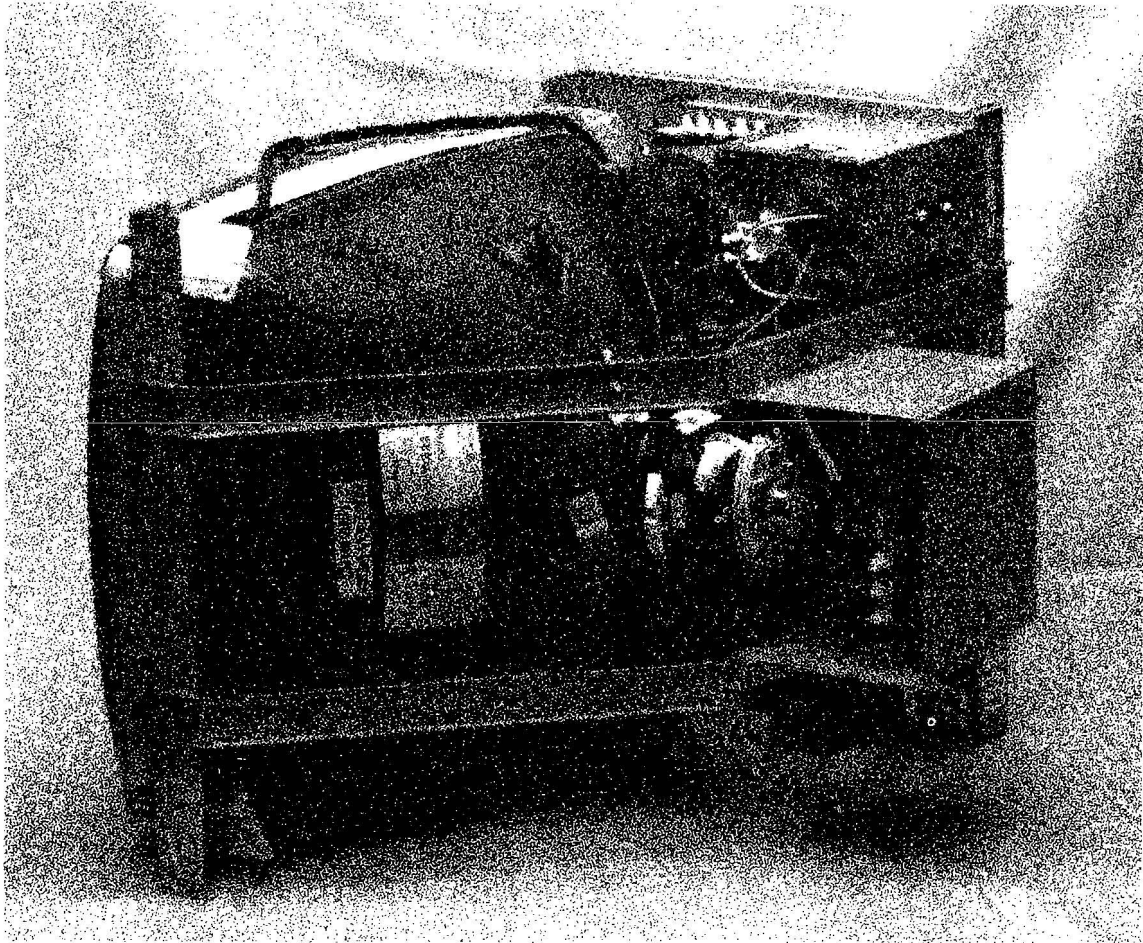


# Sharp 19-Inch Color Raster Video Display

## Service Manual

With Schematic and Illustrated Parts List



Atari Games Corporation  
675 Sycamore Drive  
P.O. Box 361110  
Milpitas, California 95035

## For technical assistance:

If reading through this manual does not lead to solving a maintenance or repair problem, call TELEHELP® at one of these Atari Games Customer Service offices:

### UNITED STATES

Atari Games Corporation  
California Customer Service Office  
737 Sycamore Drive  
P.O. Box 361110  
Milpitas, CA 95035

**Fax (408) 434-3945**  
**Telex 5101007850**

(Monday-Friday, 7:30-4:00 pm Pacific Time)

**☎ (408) 434-3950**

### EUROPE

Atari Games Ireland Limited  
European Customer Service Office  
Tipperary Town, Ireland

**Fax 062-51702**  
**Telex 28165**

(Monday-Friday, 9:00-5:30 pm GMT)

**☎ 062-52155**

© 1987 by Atari Games Corporation

All rights reserved.

No part of this publication may be reproduced by any mechanical, photographic, or electronic process, or in the form of a phonographic recording, nor may it be stored in a retrieval system, transmitted, or otherwise copied for public or private use, without permission from the publisher.

The game play, all graphic designs, this technical manual, its accompanying schematic diagrams, and the display manual are protected by the U.S. Copyright Act of 1976.

This Act provides for increased penalties for violating federal copyright laws. Courts *can impound* infringing articles while legal action is pending. If infringers are convicted, courts can *order destruction* of the infringing articles.

In addition, the Act provides for payment of statutory damages of up to \$250,000 in certain cases. Infringers may also have to pay costs and attorneys' fees and face an imprisonment of up to five years.

Atari Games Corporation will aggressively enforce its copyrights against any infringers. *We will use all legal means* to immediately halt any manufacture, distribution, or operation of a copy of video games made by us. Anyone who purchases such copies risks forfeiting such a game.

Published by:  
Atari Games Corporation  
675 Sycamore Drive  
P.O. Box 361110  
Milpitas, California 95035

Printed in the U.S.A.    **5R**

# Table of Contents

<b>1</b>	<b>Warnings and Cautions</b>	
	Introduction .....	1
	Before You Start .....	1
	Safety Measures .....	1
	Cathode-Ray Tube Handling .....	2
	Replace with Proper Components .....	2
	Final Testing Before Reinstalling Display .....	3
<b>2</b>	<b>Specifications</b>	
	Power Input and Consumption .....	3
	Temperature and Humidity .....	3
	Current and Voltages .....	3
	CRT Specifications .....	3
	Connectors .....	3
	Pattern Size .....	3
<b>3</b>	<b>Control Adjustments</b>	
	Brightness .....	4
	Tracking .....	4
	Horizontal Centering .....	6
	Vertical Hold .....	6
	Vertical Size .....	6
	Horizontal Width .....	6
	Focus .....	6
	Horizontal Hold .....	6
<b>4</b>	<b>Signal Test Points</b>	
	RGB Signals .....	6
	Sync Signal .....	7
<b>5</b>	<b>Repair</b>	
	Cathode-Ray Tube Replacement .....	7
	Yoke Replacement .....	7
	Horizontal-Output Transformer Replacement .....	8
<b>6</b>	<b>Adjustments</b>	
	Purity Adjustments .....	9
	Convergence Adjustments .....	9
	B+ Adjustment .....	10

# List of Illustrations

Figure 1	Overview of Sharp 19-Inch Color Raster Display .....	2
Figure 2	Display Pattern Sizes .....	4
Figure 3	Adjustable Controls and Test Points on Main Chassis PCB and Control PCB .....	5
Figure 4	Blanking Pulse Waveform of Video Amplifiers .....	5
Figure 5	Adjustable Controls on Picture Tube Socket PCB .....	5
Figure 6	Purity and Convergence Adjustments .....	10
Figure 7	Sharp XM-2001N Video Display Schematic Diagram .....	18

# 1 Warnings and Cautions

## Introduction

This display is contained within a separate chassis inside the game cabinet. The Main Chassis printed-circuit board (PCB) is mounted to the display chassis under the video tube, the Control PCB is located next to the Main Chassis PCB, and the Picture Tube Socket PCB is attached to the neck pins of the video tube. Input signals for the display are supplied through a 6-pin harness connector to the Main Chassis PCB. (See Figure 1.)

## Before You Start

Never attempt to work on a display until you are familiar with servicing precautions and procedures necessary for high-voltage equipment. Remember, any video display has three sources of possible danger:

- Strong electric shock, due to high voltage or AC line voltage
- X-ray radiation
- Implosion

Therefore, never modify any circuit in this display.

Do not service this video display until you are thoroughly familiar with all warnings and safety measures given in this chapter.

<b>⚠ WARNING ⚠</b>
<b>High Voltage</b>
This display contains high voltages capable of delivering lethal quantities of energy. To avoid danger, do not attempt to service the chassis until you have observed all precautions necessary for working on high-voltage equipment.
<b>X-Radiation</b>
This chassis has been designed for minimum X-radiation hazard. However, to avoid possible exposure to soft X-radiation, it is imperative that you never modify the high-voltage circuitry.
<b>Implosion Hazard</b>
If you drop the display and the picture tube breaks, it will implode! Shattered glass and the yoke can fly 6 feet or more from the implosion. Use care when replacing any display.

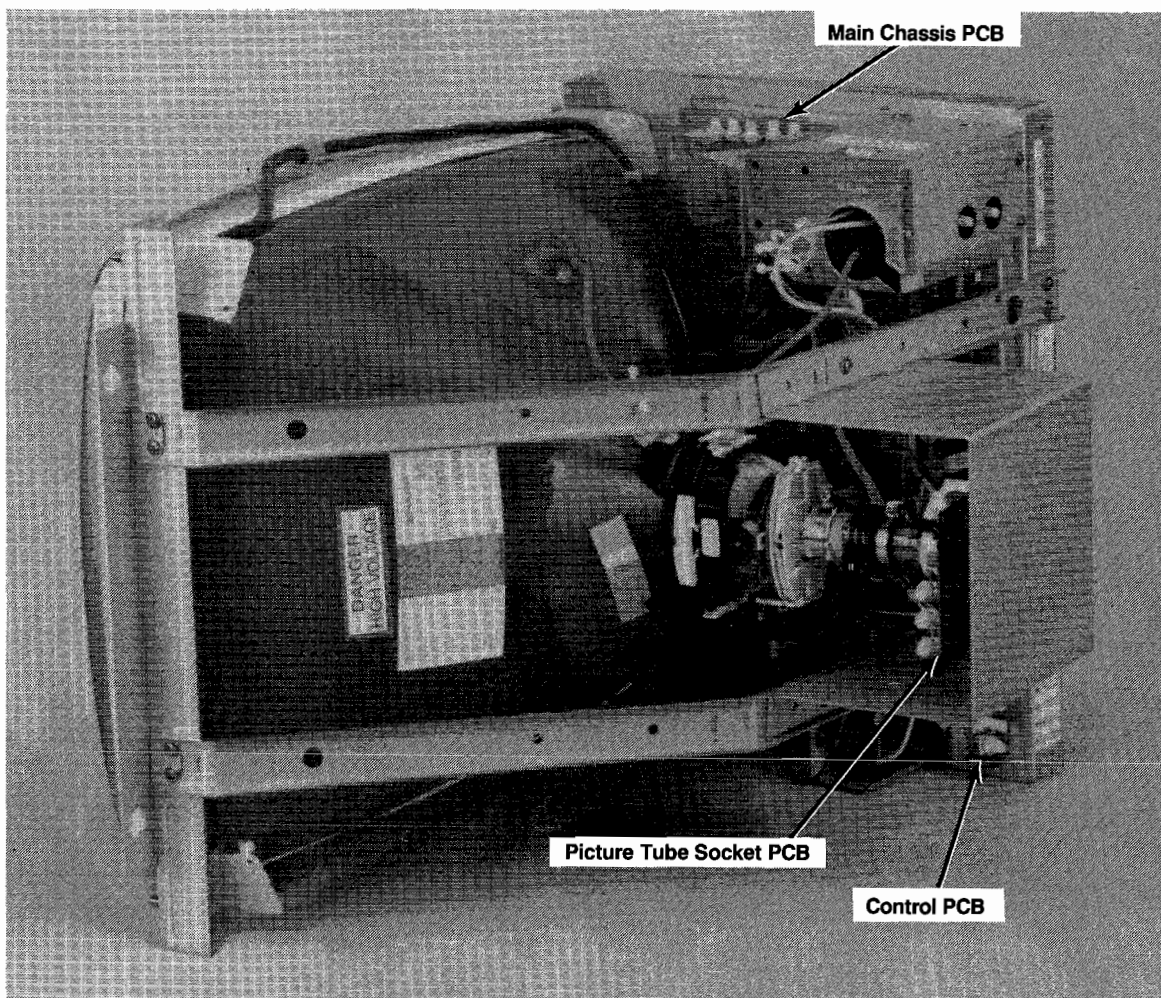
## Safety Measures

Good safety habits will allow you to automatically take the proper precautions, even if you are rushed. Whenever you work on a display, always ground the chassis first. Also, use only one hand. This avoids the possibility of carelessly putting one hand on the chassis or ground and the other on an electrical connection. Doing so could cause a severe electrical shock.

If you service the Sharp Color Raster Display on a test bench, use only the power supply that came with the game or a 100 VAC isolation transformer. (Refer to the parts list in the game manual for the Atari part number of the power supply assembly.) Do not use line voltage because the voltage produced by this source will damage this display.

To prevent fire or shock hazard, never expose this display to moisture.

Periodically check for frayed insulation on the wires within the display. If frayed wires are found, replace them with the



**Figure 1 Overview of Sharp 19-Inch Color Raster Display**

same gauge and length of wire. Always observe the original lead dress (routing and length of harness wires).

Use extra precaution in the high-voltage circuitry areas of the display. If a short circuit occurs, replace any components that indicate they may have overheated.

## Cathode-Ray Tube Handling

Wear safety goggles and heavy gloves for protection whenever you handle a cathode-ray tube (CRT). Keep other people away if they are not wearing safety goggles. Never lift the CRT by the neck; the neck should only be used to guide the lifting process.

Use extreme care when handling the CRT. Rough handling may cause the CRT tube to implode. Do not nick or scratch the glass or subject any undue pressure upon the tube at any time.

If servicing the CRT, first discharge the high voltage on the anode connection to chassis ground—not to the cabinet or

other mounting parts. See Chapter 5, step 3 of the Cathode-Ray Tube Replacement procedure to discharge the high voltage.

## Replace with Proper Components

Maintain the specified values of all components within the display. Failure to do so could cause a rise in the high voltage.

The cathode-ray tube of this display employs integral implosion protection. For continued safety, replace it only with a tube of the same type number. Refer to the parts lists in Chapter 7 of this manual. **For continued product safety, use only exact replacement parts**, especially for those parts identified in the parts lists with the ▲ symbol and on the schematics with shading.

## Final Testing Before Reinstalling Display

Before reinstalling this color display into the game, you must check the following:

1. Inspect all harness wiring within the display area. Be sure no wires or cables are pinched between the cabinet and other parts in the display.
2. Replace all protective devices such as insulating fish paper, compartment covers, and shields.

# 2 Specifications

## Power Input and Consumption

Line Voltage	100 VAC, within +10% and -15%
Line Frequency	47 to 63 Hz
Power Consumption	74 W maximum

## Temperature and Humidity

### Ambient Air Temperature:

Operating	0°C to +55°C (+32°F to +130°F)
Non-operating	-40°C to +65°C (-40°F to +149°F)
Humidity	10% to 90%, non-condensing

## Current and Voltages

CRT Anode Current (Average)	Less than 650 $\mu$ A
High Voltage	24 kV $\pm$ 1.5 kV

## CRT Specifications

### Convergence Tolerance:

At Screen Center	0.010 inch (0.25 mm) maximum misconvergence
At Screen Edges	0.020 inch (0.5 mm) maximum misconvergence

Color Purity	Practically uniform throughout the screen area after degaussing with a hand-held degaussing coil.
--------------	---

### Scan Rates:

Horizontal	15.75 kHz, within $\pm$ 500 Hz
Vertical	60 Hz, within $\pm$ 5 Hz
CRT Type	V13510YWB22, 19-inch, 90°
Tilt of Deflection Yoke	Declination of a horizontal line is within 0.10 inch (2.54 mm).

## Connectors

### 6-Pin Connector for Video Signals:

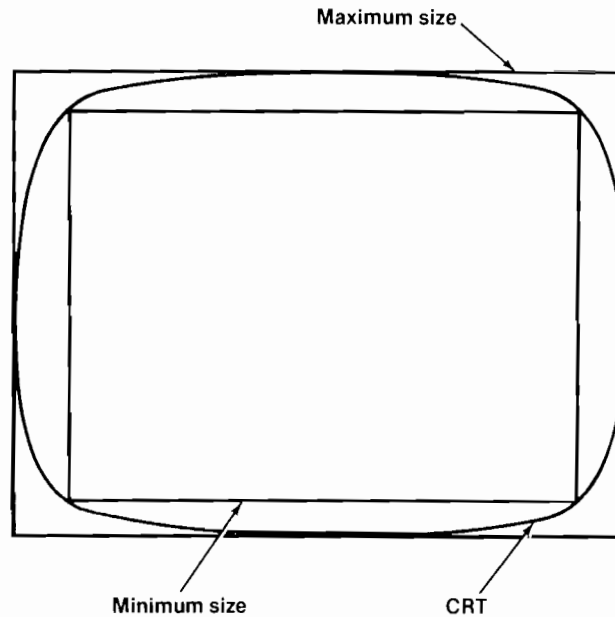
Pin 1	Green
Pin 2	Red
Pin 3	Blue
Pin 4	Ground
Pin 5	Ground
Pin 6	Negative Composite Sync

### 3-Pin Connector for Power:

Pin 1	100 VAC
Pin 2	No Connection
Pin 3	Neutral

## Pattern Size

You should be able to reproduce the patterns as shown in Figure 2.



**Figure 2 Display Pattern Sizes**

## 3 Control Adjustments

### ⚠ WARNING ⚠

Remember to observe the precautions regarding high voltages when making adjustments to this display!

### NOTE

Too high a brightness level will cause the retrace lines to show; too low a level will cause the entire screen to be dark and obscure.

### NOTE

Before making any of the following adjustments, turn on the display and allow it to warm up for at least 5 minutes.

### Brightness

The BRIGHT control R495 should be adjusted if the picture image is either too bright or too dark. See Figure 3 for the location of the Brightness control on the Control Printed-Circuit Board (PCB).

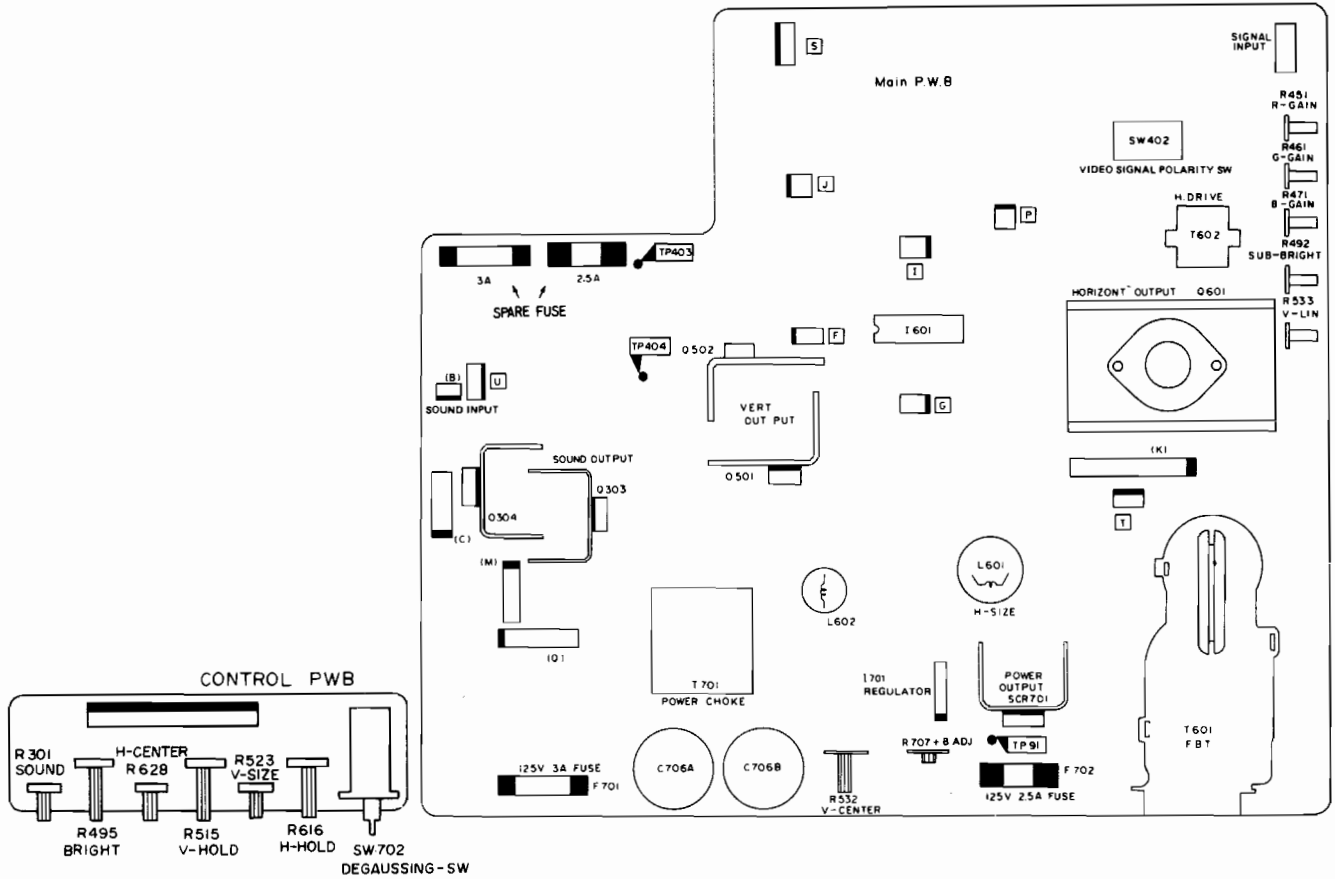
1. Place the game in the attract or play mode.
2. Using the Brightness control, adjust the display for a pleasing level of brightness.

3. If the proper level of brightness cannot be obtained by adjusting the Brightness control, adjust the SUB-BRIGHT control R492 as follows:
  - a. Set the game to display the self-test diagnostic pattern showing a white crosshatch. (Refer to the Self-Test chapter in the game manual for details on selecting this pattern.)
  - b. Attach an oscilloscope probe to each collector of the video amplifiers Q801, Q802, and Q803 and observe the blanking pulse waveform of each amplifier. The one with the most deflection of the blanking pulse is the lead gun.
  - c. Adjust the Sub-Brightness control so that the waveform is similar to the one shown in Figure 4.

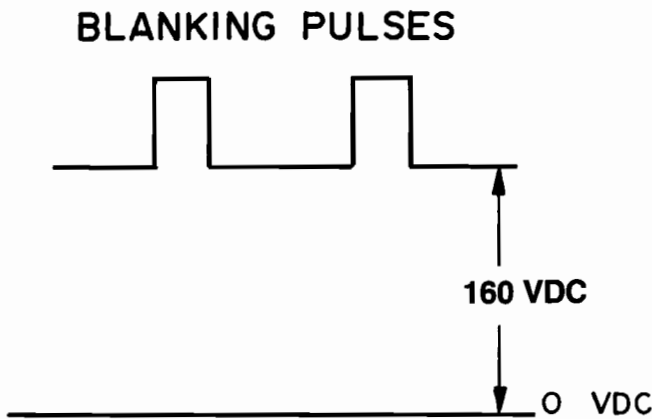
### Tracking

The Screen, Brightness, the three Bias, and two Drive controls should be adjusted if the picture image is not the correct



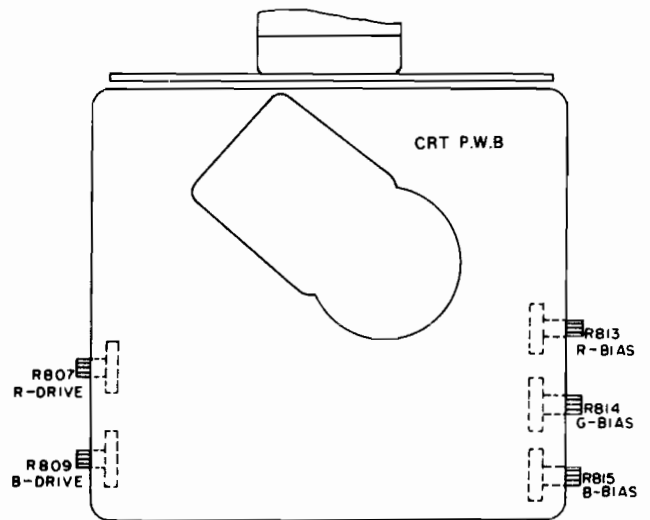


**Figure 3 Adjustable Controls and Test Points on Main Chassis PCB and Control PCB**



**Figure 4 Blanking Pulse Waveform of Video Amplifiers**

color or brightness, and whenever the purity and convergence is adjusted. (See Figure 3 for the location of the Screen and Brightness controls and Figure 5 for the Bias and Drive controls.)



**Figure 5 Adjustable Controls on Picture Tube Socket PCB**

1. Remove power from both the game and the display.
2. Unplug the 6-pin video-signal connector, which is wired to the Main Chassis PCB.
3. Set the R-DRIVE control R807 and the B-DRIVE control R809 to their mechanical centers.
4. Set all three BIAS controls R813, R814, and R815 to their mechanical centers.
5. Set the Brightness control to its mechanical center and the Screen control fully counterclockwise.
6. If the game has a self-test diagnostic pattern for the color purity test, set the game to display this test to complete the white tracking procedure. If the game does not have a color purity test, an RGB signal generator capable of producing a gray and a white raster is necessary.
7. Reconnect the 6-pin video-signal connector and apply power to the display.
8. Set the game to display the self-test diagnostic pattern showing the gray raster.
9. Slowly adjust the Screen control until the CRT screen displays the first hint of color. Do not adjust the Bias control for the color that first appeared on the screen. Instead, slowly adjust the Bias controls for the other two colors until the screen displays a faint gray color.
10. Set the game to display the self-test diagnostic pattern showing the white raster, and adjust the R-Drive and B-Drive controls for a uniform white. (Note: repeat steps 8 and 9 so that both the gray and white rasters have uniform color.)
11. Return the game to the attract mode. If necessary, adjust the Brightness control if the screen appears to be too dark or too bright.

## Horizontal Centering

The Horizontal Centering control should be adjusted if the picture is not centered on the screen, as indicated by a black area at either the left or the right edge. Figure 3 shows the location of the H-CENT control R628 on the Control PCB. Adjust this control until a normal screen image is obtained.

## Vertical Hold

The Vertical Hold control should be adjusted if the picture drifts straight up or down on the screen. Figure 3 shows the

location of V-HOLD control R515 on the Control PCB. Turn this control until the picture no longer drifts up or down on the screen.

## Vertical Size

The Vertical Size control should be adjusted if the screen image is either not filling the screen vertically, or if it is overscanning the screen vertically. Figure 3 shows the location of V-SIZE control R523 on the Control PCB.

1. Set the game for the diagnostic test that displays the convergence grid and dots.
2. Adjust V-SIZE control until the top and bottom grid lines are along the top and bottom edges of the screen. These grid lines should not disappear off the edges of the screen, which would indicate overscanning.

## Horizontal Width

The Horizontal Width coil should be adjusted if the screen image is either too wide or narrow. Figure 3 shows the location of HORIZ WIDTH coil L601 on the Main Chassis PCB.

1. Set the game for the diagnostic test that displays the convergence grid and dots.
2. Use only a non-metallic Allen wrench (commonly called a "tweaking tool") to adjust the Horizontal Width coil until the right and left grid lines run along the edges of the screen. These grid lines should not disappear off the edges of the screen, which would indicate overscanning.

## Focus

The Focus control should be adjusted if the screen image is not sharply defined. The Focus control is attached to the top of the horizontal-output transformer as shown in Figure 3. Turn this control until you get optimum screen sharpness.

## Horizontal Hold

The Horizontal Hold control should be adjusted if the picture is drifting sideways across the screen. Figure 3 shows the location of H-HOLD control R616 on the Control PCB. Adjust this control until the black lines no longer slant downward or upward and you get a normal screen image.

# 4 Signal Test Points

## RGB Signals

The red, green, and blue signals can be checked at the collectors of Q801 (Red), Q802 (Green), and Q803 (Blue).

These transistors are located on the Picture Tube Socket PCB.

## Sync Signal

The negative composite synchronization (Sync) signal can be checked at pin 6 of the 6-pin video-signal connector, which is located off of the Main Chassis PCB. Do not jam a

test probe into the connector pin, because this may cause the pin to stretch and fall out of the connector housing.

# 5 Repair

### ⚠ WARNING ⚠

Before removing or installing any component of this display, always disconnect the power source! Observe the precautions regarding high voltages and cathode-ray tube handling when servicing this display.

### NOTE

The tools required to replace these assemblies include: 5/16-inch hex socket wrench, Phillips screwdriver, and a soldering iron.

## Cathode-Ray Tube Replacement

1. Disconnect the 6-pin video-signal connector located off the Main Chassis PCB.
2. Remove the display assembly from the cabinet as described in the game manual.
3. Discharge the high voltage from the cathode-ray tube (CRT) as follows:
  - a. Attach one end of a well-insulated, 20 kV-resistive jumper to ground.
  - b. Briefly touch the free end of the resistive jumper to the anode by sliding it under the anode cap.
  - c. Wait two minutes.
  - d. Discharge the anode again.
  - e. CAREFULLY remove the large high-voltage anode connector from the cathode-ray tube.
4. Unplug the Picture Tube Socket PCB from the rear of the tube.
5. Unplug the degaussing coil 2-pin connector from the Main Chassis PCB.
6. Unplug the 4-wire connector attaching the yoke wires to the Main Chassis PCB.
7. Unhook the spring that holds the braided ground wire (located near the bottom corner of the CRT).
8. Use a 5/16-inch hex socket wrench to remove the four screws holding the CRT to the steel frame.

9. CAREFULLY remove the CRT by easing it out the front of the chassis.
10. Place the CRT on a soft mat in a protected location.
11. Install a CRT in the reverse order of removal. Then adjust the SCREEN control G2 as follows:
  - a. Apply power to the display.
  - b. Turn the Brightness control on the Control PCB to the fully counterclockwise position.
  - c. Adjust the Screen control for a dimly-lighted screen. This control is attached to the horizontal-output transformer as shown in Figure 3.
  - d. Readjust the Brightness control as described in Chapter 3.

## Yoke Replacement

### NOTE

You must reconverge the picture whenever the yoke is replaced.

1. Disconnect the 6-pin video-signal connector located off the Main Chassis PCB.
2. Remove the display assembly from the cabinet as described in the game manual.
3. Discharge the high voltage from the CRT as described in step 3 of *Cathode-Ray Tube Replacement*.
4. Unplug the Picture Tube Socket PCB from the rear of the CRT.
5. Use a thin knife or a single-edged razor blade and carefully loosen the three rubber wedges from the CRT surface.
6. Loosen the Phillips-head screws used to tighten the two neck clamps around the neck of the CRT.
7. Slide the magnet assembly and the yoke assembly off the end of the CRT.
8. Replace the yoke assembly in the reverse order of removal.

## Horizontal-Output Transformer Replacement

1. Disconnect the 6-pin video-signal connector located off the Main Chassis PCB.
2. Remove the display assembly from the cabinet as described in the game manual.
3. Discharge the high voltage from the CRT as described in step 3 of *Cathode-Ray Tube Replacement*.
4. Open the anode holder and remove the anode lead.
5. Unplug the Picture Tube Socket PCB at the rear of the CRT. Then unsolder the red wire (goes to K806) and white wire (goes into the socket) on that PCB.
6. Remove the Phillips-head screws that secure the metal cover over the transformer.
7. Remove the Phillips-head screw holding the metal bracket to the right side of the transformer.
8. Unsolder the 11 transformer connections on the bottom side of the Main Chassis PCB.
9. Lift the transformer off the Main Chassis PCB.
10. Replace the transformer in the reverse order of removal. Be sure to check the picture for sharpness. If appropriate, readjust the Focus control as described in Chapter 3.

# 6 Adjustments

## ⚠ WARNING ⚠

Remember to observe the precautions regarding high voltages when making adjustments on this display!

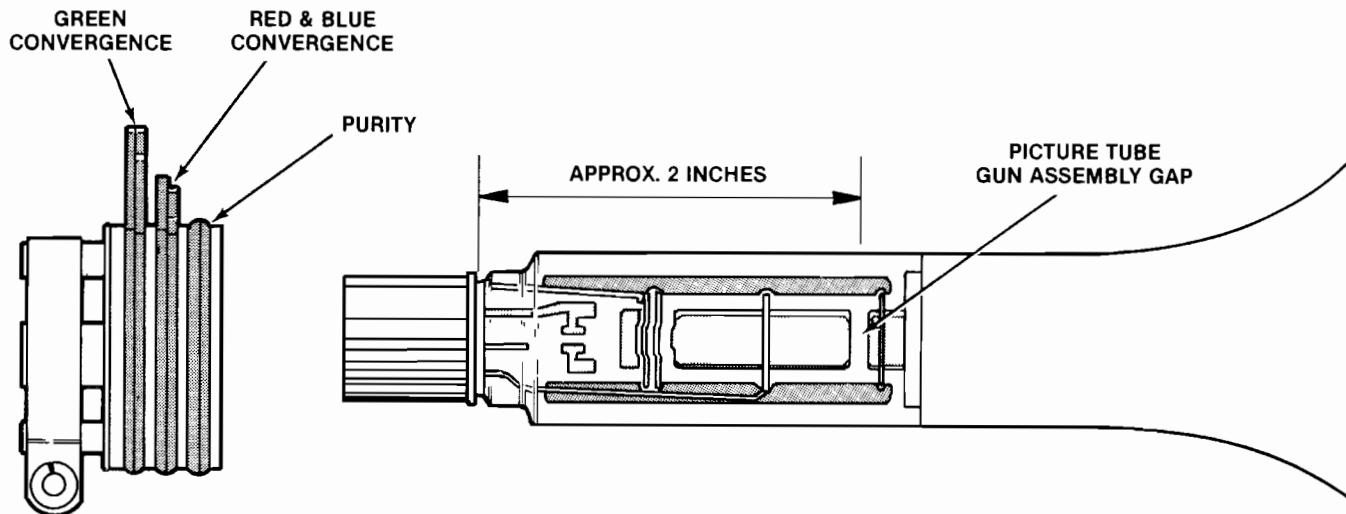
Before adjusting the display, remove the display assembly from the cabinet as described in the game manual. Leave all cables connected between the display assembly and other parts of the game.

## Purity Adjustments

1. Set up the display for the purity adjustments as follows:
  - a. If you will also be adjusting the convergence of the outer screen area, loosen the mounting screws for both the deflection yoke and the magnet.
  - b. Position the cabinet so that the CRT faces either north or south.
  - c. Degauss the CRT tube with a hand-held degaussing coil.
2. Adjust for red purity as follows:
  - a. Turn off the green and blue guns of the CRT by rotating the G-BIAS R814 and B-BIAS R815 controls to the fully counterclockwise position. (See Figure 5 for the location of the Bias adjustments.)
  - b. Set the game to display any self-test diagnostic pattern that shows solid white. Keep this image throughout the purity adjustments. (Refer to the Self-Test chapter in the game manual for details on selecting this pattern.)
  - c. Rotate and spread the tabs of the purity magnets until the screen image is centered both horizontally and vertically. (See Figure 6.)
  - d. Readjust the purity magnets for a uniformly red screen. This may interact with the previous adjustment made in step 2c.
3. Adjust for green purity as follows:
  - a. Turn off the red and blue guns of the CRT by rotating the R-BIAS R813 and B-BIAS R815 controls to the fully counterclockwise position.
  - b. Readjust the purity magnets, if necessary, for a uniformly green screen. This may interact with the previous adjustment.
4. Adjust for blue purity as follows:
  - a. Turn off the red and blue guns of the CRT by rotating the R-Bias and G-Bias controls to the fully counterclockwise position.
  - b. Readjust the purity magnets, if necessary, for a uniformly blue screen. This may interact with the previous adjustments.
5. Return the R-Bias, G-Bias, and B-Bias controls to their original settings. Check the screen for a pure white display that is not tinted with other hues.
6. Reinstall the display in the game.
7. Perform the convergence adjustments.

## Convergence Adjustments

1. Adjust for static convergence (screen center) as follows:
  - a. If you will also be converging the outer area of the picture, loosen the mounting screws for the deflection yoke and magnet, if not already done as part of the purity adjustments.
  - b. Set the game to display the self-test diagnostic pattern that shows a black background with white lines and dots. Keep this image on the display throughout all convergence adjustments.
  - c. Turn off the green gun of the CRT by rotating the G-Bias control to the fully counterclockwise position. Figure 4 shows the location of the Bias controls.
  - d. Adjust the angle of the center pair of magnets to superimpose the red and blue vertical lines in the center of the screen area. (See Figure 5.)
  - e. Keeping their angles the same, rotate both tabs of the center pair of magnets to superimpose the red and blue horizontal lines in the center of the screen area.
  - f. Turn on the green gun of the CRT by returning the G-Bias control to its original setting.
  - g. Adjust the angle of the rear pair of magnets shown in Figure 5 to superimpose the green vertical lines on the red and blue ones already in the center of the screen.
  - h. Keeping their angles the same, rotate both tabs of these magnets to superimpose the green horizontal lines on the red and blue ones in the center of the screen.
2. Adjust the dynamic convergence (outer screen) as follows:
  - a. Use a razor blade or thin knife and carefully loosen the glue holding the three rubber wedges beneath the yoke collar. Remove these wedges.



**Figure 6 Purity and Convergence Adjustments**

- b. Check that the mounting screws for the deflection yoke assembly and the magnet assembly are loosened.
- c. Slide the yoke slightly away from the CRT.
- d. Move the yoke until the outer lines and dots on the screen are pure white. The up/down movement of the yoke causes the outer edges of the screen image to swivel clockwise/counterclockwise. A side-to-side movement causes the lines and dots at the outer screen edges to expand and contract.
- e. Secure the deflection yoke in position by putting the wedges back between the CRT and the yoke collar.
- f. Secure the wedges with white glue.
- g. Tighten the mounting screws to secure the magnet and deflection yoke assemblies.

3. Perform the tracking adjustments in Chapter 3.

### **B+ Adjustment**

1. Set the Brightness control on the Control PCB for maximum brightness.
2. Set a DC voltmeter to the 0-volt to +150-volt range.
3. Connect the plus lead of the voltmeter to test point 91. (See Figure 3.)
4. Connect the minus lead of the voltmeter to ground.
5. Adjust R707 located near the DC fuse on the Main Chassis PCB for a voltmeter reading of +110 V.
6. Return the Brightness control to its normal setting.

**Sharp Model XM-2001N Video Display**  
**Atari Part Number 139021-001**  
**Parts List**

**NOTE**

This video display contains circuits and components included specifically for safety purposes. The ▲ symbol is used in the parts list to mark safety-critical components that you should replace only with exact factory replacement parts. Using substitute parts may create a shock, fire, radiation, or other hazard. Only qualified personnel should service this video display.

Designator	Description	Part No.
<b>Printed-Circuit Board Assemblies</b>		
▲	Assembly, Main PCB	99-213001
▲	Assembly, CRT PCB	99-213002
▲	Assembly, Control PCB	99-213003
▲	Assembly, Interconnect PCB	99-213004
<b>Capacitors</b>		
C301–C302 ▲	Capacitor, Electrolytic, 10 $\mu$ F, 16 V	99-213119
C304	Capacitor, Electrolytic, 10 $\mu$ F, 160 V	99-213129
C305	Capacitor, Electrolytic, 330 $\mu$ F, 160 V	99-213112
C306	Capacitor, Electrolytic, 100 $\mu$ F, 25 V	99-213122
C307	Capacitor, Ceramic, 150 pF, 50 V	99-213116
C308	Capacitor, Mylar, 1k pF, 50 V	99-213143
C310	Capacitor, Electrolytic, 470 $\mu$ F, 160 V	99-213113
C401	Capacitor, Electrolytic, 47 $\mu$ F, 25 V	99-213150
C402	Capacitor, Ceramic, 0.01 $\mu$ F, 50 V	99-213140
C403	Capacitor, Electrolytic, 10 $\mu$ F, 50 V	99-213125
C405–C406	Capacitor, Electrolytic, 330 $\mu$ F, 25 V	99-213123
C407	Capacitor, Ceramic, 0.01 $\mu$ F, 50 V	99-213140
C408	Capacitor, Electrolytic, 100 $\mu$ F, 16 V	99-213120
C409	Capacitor, Electrolytic, 100 $\mu$ F, 25 V	99-213122
C501	Capacitor, Mylar, 0.056 $\mu$ F, 50 V	99-213147
C502	Capacitor, Ceramic, 150 pF, 50 V	99-213116
C503	Capacitor, Tant, 2.2 $\mu$ F, 35 V	99-213149
C504	Capacitor, Electrolytic, 1 $\mu$ F, 50 V	99-213124
C505	Capacitor, Ceramic, 39 pF, 50 V	99-213118
C506	Capacitor, Electrolytic, 33 $\mu$ F, 16 V	99-213132
C508	Capacitor, Electrolytic, 10 $\mu$ F, 25 V	99-213121
C509	Capacitor, Electrolytic, 330 $\mu$ F, 50 V	99-213126
C511	Capacitor, Ceramic, 0.0047 $\mu$ F, 50 V	99-213152
C511	Capacitor, Mylar, 4700 pF, 50 V	99-213146
C514	Capacitor, Electrolytic, 100 $\mu$ F, 16 V	99-213120
C515	Capacitor, Ceramic, 0.01 $\mu$ F, 500 V	99-213137
C516	Capacitor, Mylar, 0.1 $\mu$ F, 50 V	99-213144
C517	Capacitor, Electrolytic, 330 $\mu$ F, 50 V	99-213126
C520	Capacitor, Electrolytic, 1 $\mu$ F, 50 V	99-213124
C601	Capacitor, Mylar, 0.1 $\mu$ F, 50 V	99-213144
C603 ▲	Capacitor, Poly Film, 3300 pF, 1600 V	99-213134
C604	Capacitor, Ceramic, 1000 pF, 500 V	99-213136

## Sharp Model XM-2001N Video Display Parts List, Continued

Designator	Description	Part No.
C605 ▲	Capacitor, Electrolytic, 4.7 $\mu$ F, 50 V	99-213127
C606	Capacitor, Ceramic, 1000 pF, 50 V	99-213139
C607 ▲	Capacitor, Electrolytic, 10 $\mu$ F, 16 V	99-213119
C608	Capacitor, Mylar, 4700 pF, 50 V	99-213146
C609	Capacitor, Electrolytic, 100 $\mu$ F, 16 V	99-213120
C610	Capacitor, Electrolytic, 10 $\mu$ F, 16 V	99-213119
C611 ▲	Capacitor, Mylar, 0.056 $\mu$ F, 50 V	99-213147
C612	Capacitor, Mylar, 0.027 $\mu$ F, 50 V	99-213145
C613	Capacitor, Mylar, 6800 pF, 50 V	99-213148
C614	Capacitor, Electrolytic, 1 $\mu$ F, 50 V	99-213124
C616 ▲	Capacitor, Polyester Film, 0.47 $\mu$ F, 200 V	99-213133
C617	Capacitor, Electrolytic, 330 $\mu$ F, 25 V	99-213123
C618	Capacitor, Ceramic, 1000 pF, 50 V	99-213139
C619	Capacitor, Ceramic, 330 pF, 50 V	99-213153
C621 ▲	Capacitor, Poly Film, 2700 pF, 1600 V	99-213141
C622 ▲	Capacitor, Poly Film, 3300 pF, 1600 V	99-213134
C627	Capacitor, Ceramic, 68 pF, 50 V	99-213151
C701 ▲	Capacitor, Ceramic, 0.1 $\mu$ F, 50 V	99-213115
C702–C703	Capacitor, Ceramic, 0.01 $\mu$ F, 1.4 kV	99-213114
C704	Capacitor, Ceramic, 0.01 $\mu$ F, 500 V	99-213137
C705	Capacitor, Electrolytic, 47 $\mu$ F, 50 V	99-213128
C706A	Capacitor, Electrolytic, 330 $\mu$ F, 160 V	99-213112
C706B	Capacitor, Electrolytic, 470 $\mu$ F, 160 V	99-213113
C707	Capacitor, Electrolytic, 100 $\mu$ F, 160 V	99-213131
C708	Capacitor, Ceramic, 4700 pF, 500 V	99-213138
C709	Capacitor, Ceramic, .047 $\mu$ F, 200 V	99-213142
C710	Capacitor, Ceramic, 0.01 $\mu$ F, 50 V	99-213140
C801–C803	Capacitor, Ceramic, 470 pF, 50 V	99-213135
C804	Capacitor, Electrolytic, 22 $\mu$ F, 250 V	99-213130
C805	Capacitor, Ceramic, 0.01 $\mu$ F, 1.4 kV	99-213114
C807–C809	Capacitor, Ceramic, 180 pF, 50 V	99-213117
<b>Diodes</b>		
D301	Diode	99-213020
D410–D412	Diode	99-213020
D414, D415	Diode	99-213020
D417–D420	Diode	99-213020
D501, D502	Diode	99-213020
D503	Diode	99-213027
D601 ▲	Diode	99-213021
D603	Diode	99-213022
D604 ▲	Diode	99-213021
D606	Diode	99-213020
D701–D704 ▲	Diode	99-213019
D707–D709	Diode	99-213020
ZD402	Diode, Zener	99-213026
ZD451, ZD461	Diode, Zener	99-213023
ZD471	Diode, Zener	99-213023
ZD601 ▲	Diode, Zener	99-213024



## Sharp Model XM-2001N Video Display Parts List, Continued

Designator	Description	Part No.
ZD602	Diode, Zener	99-213028
ZD701	Diode, Zener	99-213025
<b>Integrated Circuits</b>		
I601 ▲	IC, X-ray Protect	99-213005
I701 ▲	IC, Regulator	99-213006
<b>Thermistors</b>		
PR701 ▲	Thermistor	99-213030
PR702	Thermistor	99-213029
<b>Transistors</b>		
Q301	Transistor, NPN	99-213017
Q302	Transistor, NPN	99-213013
Q303	Transistor, NPN	99-213015
Q304	Transistor, PNP	99-213010
Q401-Q406	Transistor, NPN	99-213011
Q408, Q409	Transistor, PNP	99-213009
Q410-Q415	Transistor, NPN	99-213011
Q501, Q502	Transistor, NPN	99-213012
Q601 ▲	Transistor, NPN	99-213018
Q602	Transistor, NPN	99-213016
Q801-Q803	Transistor, NPN	99-213014
<b>Resistors</b>		
R301	Potentiometer, Trimming, 10 k $\Omega$	99-213046
R302	Resistor, Carbon, 120 k $\Omega$ , ¼ W	99-213058
R303	Resistor, Carbon, 18 k $\Omega$ , ¼ W	99-213063
R304	Resistor, Carbon, 270 $\Omega$ , ¼ W	99-213066
R305	Resistor, Carbon, 270 k $\Omega$ , ¼ W	99-213068
R306	Resistor, Carbon, 3.3 k $\Omega$ , ¼ W	99-213069
R311	Resistor, Carbon, 18 k $\Omega$ , ½ W	99-213086
R313	Resistor, Carbon, 12 k $\Omega$ , ¼ W	99-213057
R314	Resistor, Carbon, 56 k $\Omega$ , ¼ W	99-213082
R315 ▲	Resistor, Carbon, 2.7 k $\Omega$ , ¼ W	99-213067
R316	Resistor, Metal Oxide, 680 $\Omega$ , 3 W	99-213102
R317	Resistor, Carbon, 390 $\Omega$ , ¼ W	99-213074
R318	Resistor, Metal Oxide, 680 $\Omega$ , 3 W	99-213102
R402	Resistor, Metal Oxide, 2.2 $\Omega$ , ½ W	99-213098
R403	Resistor, Metal Oxide, 1 $\Omega$ , ½ W	99-213096
R404, R406	Resistor, Carbon, 1 k $\Omega$ , ¼ W	99-213055
R407 ▲	Resistor, Carbon, 10 k $\Omega$ , ¼ W	99-213056
R408	Resistor, Carbon, 1 k $\Omega$ , ¼ W	99-213055
R409	Resistor, Carbon, 1.8 k $\Omega$ , ¼ W	99-213062
R410	Resistor, Carbon, 1 k $\Omega$ , ¼ W	99-213055
R412	Resistor, Carbon, 2.2 k $\Omega$ , ¼ W	99-213064
R413 ▲	Resistor, Carbon, 10 k $\Omega$ , ¼ W	99-213056
R414	Resistor, Carbon, 1 k $\Omega$ , ¼ W	99-213055
R415	Resistor, Carbon, 1.8 k $\Omega$ , ¼ W	99-213062

## Sharp Model XM-2001N Video Display Parts List, Continued

Designator	Description	Part No.
R416	Resistor, Carbon, 1 k $\Omega$ , ¼ W	99-213055
R418	Resistor, Carbon, 2.2 k $\Omega$ , ¼ W	99-213064
R420	Resistor, Metal Oxide, 5.6 k $\Omega$ , 1 W	99-213097
R422	Resistor, Carbon, 2.2 k $\Omega$ , ¼ W	99-213064
R423	Resistor, Carbon, 470 $\Omega$ , ¼ W	99-213077
R424	Resistor, Carbon, 270 $\Omega$ , 1.4 W	99-213066
R427	Resistor, Carbon, 470 $\Omega$ , ¼ W	99-213077
R428	Resistor, Metal Oxide, 82 $\Omega$ , 3 W	99-213103
R430	Resistor, Carbon, 1 k $\Omega$ , ¼ W	99-213055
R431	Resistor, Carbon, 1.8 k $\Omega$ , ¼ W	99-213062
R432 ▲	Resistor, Carbon, 10 k $\Omega$ , ¼ W	99-213056
R433–R435	Resistor, Carbon, 15 k $\Omega$ , ¼ W	99-213059
R436 ▲	Resistor, Carbon, 10 k $\Omega$ , ¼ W	99-213056
R437	Resistor, Carbon, 470 $\Omega$ , ¼ W	99-213077
R438	Resistor, Carbon, 1.5 k $\Omega$ , ¼ W	99-213071
R439 ▲	Resistor, Carbon, 10 k $\Omega$ , ¼ W	99-213056
R450	Resistor, Carbon, 33 k $\Omega$ , ¼ W	99-213070
R451	Potentiometer, Trimming, 5 k $\Omega$	99-213042
R452	Resistor, Carbon, 1 k $\Omega$ , ¼ W	99-213055
R453	Resistor, Carbon, 100 $\Omega$ , ¼ W	99-213054
R454	Resistor, Carbon, 560 $\Omega$ , ¼ W	99-213080
R455 ▲	Resistor, Carbon, 10 k $\Omega$ , ¼ W	99-213056
R456	Resistor, Carbon, 15 k $\Omega$ , ¼ W	99-213059
R457	Resistor, Carbon, 1.5 k $\Omega$ , ¼ W	99-213071
R458	Resistor, Carbon, 820 $\Omega$ , ¼ W	99-213072
R460	Resistor, Carbon, 33 k $\Omega$ , ¼ W	99-213070
R461	Potentiometer, Trimming, 5 k $\Omega$	99-213042
R462	Resistor, Carbon, 1 k $\Omega$ , ¼ W	99-213055
R463	Resistor, Carbon, 100 $\Omega$ , ¼ W	99-213054
R464	Resistor, Carbon, 560 $\Omega$ , ¼ W	99-213080
R465 ▲	Resistor, Carbon, 10 k $\Omega$ , ¼ W	99-213056
R466	Resistor, Carbon, 15 k $\Omega$ , ¼ W	99-213059
R467	Resistor, Carbon, 1.5 k $\Omega$ , ¼ W	99-213071
R468	Resistor, Carbon, 820 $\Omega$ , ¼ W	99-213072
R470	Resistor, Carbon, 33 k $\Omega$ , ¼ W	99-213070
R471	Potentiometer, Trimming, 5 k $\Omega$	99-213042
R472	Resistor, Carbon, 1 k $\Omega$ , ¼ W	99-213055
R473	Resistor, Carbon, 100 $\Omega$ , ¼ W	99-213054
R474	Resistor, Carbon, 560 $\Omega$ , ¼ W	99-213080
R475 ▲	Resistor, Carbon, 10 k $\Omega$ , ¼ W	99-213056
R476	Resistor, Carbon, 15 k $\Omega$ , ¼ W	99-213059
R477	Resistor, Carbon, 1.5 k $\Omega$ , ¼ W	99-213071
R478	Resistor, Carbon, 820 $\Omega$ , ¼ W	99-213072
R481–R483	Resistor, Carbon, 4.7 k $\Omega$ , ¼ W	99-213078
R484–R486	Resistor, Carbon, 470 $\Omega$ , ¼ W	99-213077
R487–R489	Resistor, Carbon, 100 $\Omega$ , ¼ W	99-213054
R490	Resistor, Carbon, 39 k $\Omega$ , ¼ W	99-213076

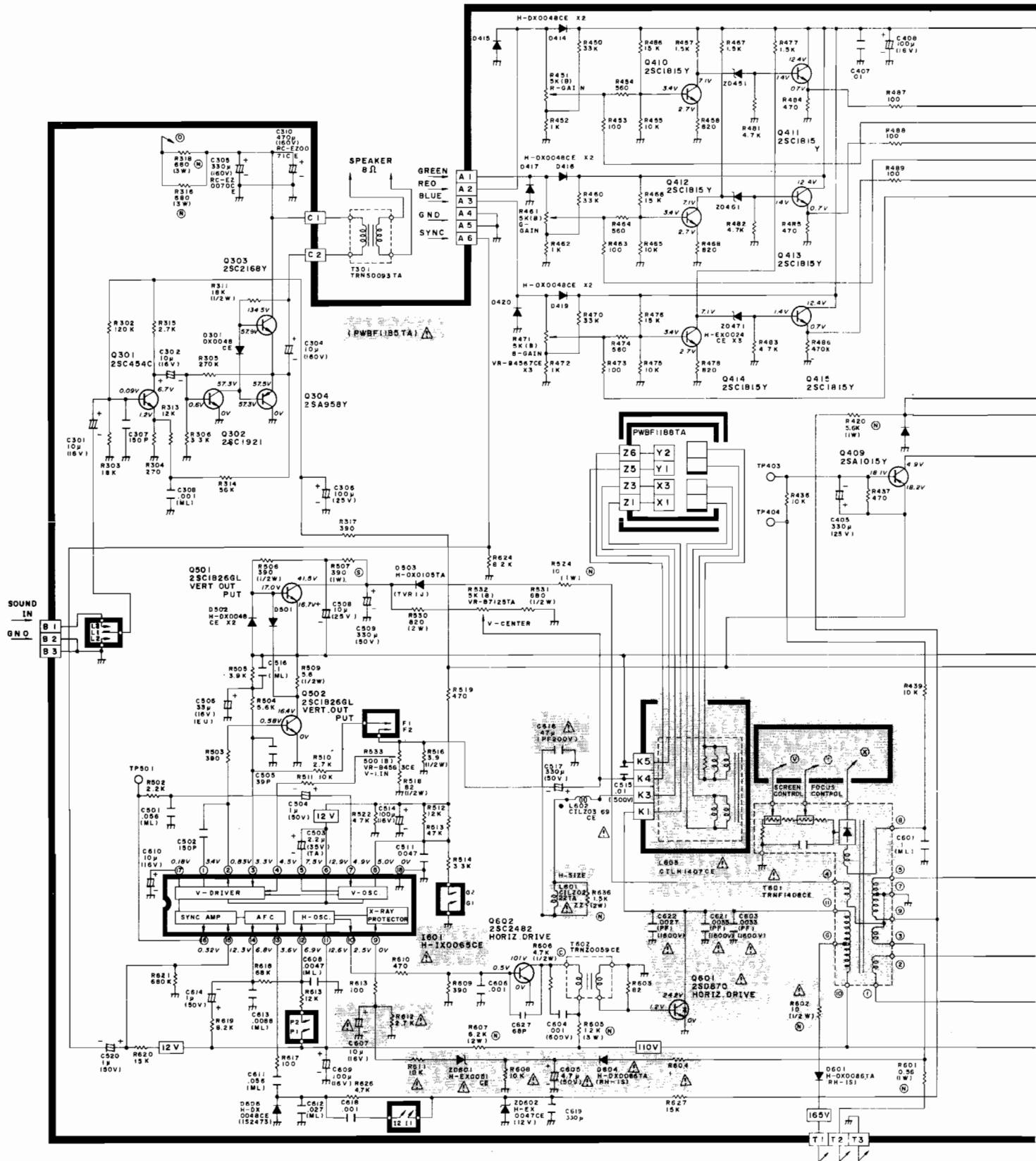
## Sharp Model XM-2001N Video Display Parts List, Continued

Designator	Description	Part No.
R491	Resistor, Carbon, 1.2 k $\Omega$ , ¼ W	99-213108
R492	Potentiometer, Trimming, 20 k $\Omega$	99-213043
R493	Resistor, Carbon, 1 k $\Omega$ , ¼ W	99-213055
R495	Potentiometer, Trimming, 10 k $\Omega$	99-213047
R496	Resistor, Carbon, 1 k $\Omega$ , ¼ W	99-213055
R502	Resistor, Carbon, 2.2 k $\Omega$ , ¼ W	99-213064
R503	Resistor, Carbon, 390 $\Omega$ , ¼ W	99-213074
R504 ▲	Resistor, Carbon, 5.6 k $\Omega$ , ¼ W	99-213081
R505 ▲	Resistor, Carbon, 3.9 k $\Omega$ , ¼ W	99-213075
R506	Resistor, Carbon, 390 $\Omega$ , ½ W	99-213088
R507	Resistor, Metal Oxide, 390 $\Omega$ , 1 W	99-213093
R508	Resistor, Carbon, 82 $\Omega$ , ½ W	99-213090
R509	Resistor, Carbon, 5.6 $\Omega$ , ½ W	99-213089
R510 ▲	Resistor, Carbon, 2.7 k $\Omega$ , ¼ W	99-213067
R511 ▲	Resistor, Carbon, 10 k $\Omega$ , ¼ W	99-213056
R512	Resistor, Carbon, 12 k $\Omega$ , ¼ W	99-213057
R513	Resistor, Carbon, 47 k $\Omega$ , ¼ W	99-213079
R514	Resistor, Carbon, 3.3 k $\Omega$ , ¼ W	99-213069
R515 ▲	Potentiometer, Trimming, 5 k $\Omega$	99-213044
R516	Resistor, Carbon, 3.9 $\Omega$ , ½ W	99-213087
R518	Resistor, Carbon, 82 $\Omega$ , ½ W	99-213090
R519	Resistor, Carbon, 470 $\Omega$ , ¼ W	99-213077
R522	Resistor, Carbon, 4.7 k $\Omega$ , ¼ W	99-213078
R523	Potentiometer, Trimming, 100 $\Omega$	99-213045
R524	Resistor, Metal Oxide, 10 $\Omega$ , 1 W	99-213110
R530	Resistor, Metal Oxide, 820 $\Omega$ , 2 W	99-213094
R531	Resistor, Carbon, 680 $\Omega$ , ½ W	99-213073
R532	Potentiometer, Trimming, 5 k $\Omega$	99-213049
R533	Potentiometer, Trimming, 500 $\Omega$	99-213040
R601	Resistor, Metal Film, 0.56 $\Omega$ , 1 W	99-213091
R602 ▲	Resistor, Metal Film, 10 $\Omega$ , ½ W	99-213092
R603	Resistor, Carbon, 82 $\Omega$ , ¼ W	99-213084
R604 ▲	Resistor, Carbon, 1 $\Omega$ , ¼ W	99-213053
R605	Resistor, Metal Oxide, 1.2 k $\Omega$ , 3 W	99-213100
R606 ▲	Resistor, Solid, 4.7 k $\Omega$ , ½ W	99-213051
R607	Resistor, Metal Film, 8.2 k $\Omega$ , 2 W	99-213111
R608 ▲	Resistor, Carbon, 10 k $\Omega$ , ¼ W	99-213056
R609	Resistor, Carbon, 390 $\Omega$ , ¼ W	99-213074
R610	Resistor, Carbon, 470 $\Omega$ , ¼ W	99-213077
R611 ▲	Resistor, Carbon, 10 k $\Omega$ , ¼ W	99-213056
R612 ▲	Resistor, Carbon, 2.7 k $\Omega$ , ¼ W	99-213067
R613	Resistor, Carbon, 100 $\Omega$ , ¼ W	99-213054
R615	Resistor, Carbon, 12 k $\Omega$ , ¼ W	99-213057
R616 ▲	Potentiometer, Trimming, 5 k $\Omega$	99-213044
R617	Resistor, Carbon, 100 $\Omega$ , ¼ W	99-213054
R618	Resistor, Carbon, 68 k $\Omega$ , ¼ W	99-213083
R619	Resistor, Carbon, 8.2 k $\Omega$ , ¼ W	99-213085
R620	Resistor, Carbon, 15 k $\Omega$ , ¼ W	99-213059

## Sharp Model XM-2001N Video Display Parts List, Continued

Designator	Description	Part No.
R621	Resistor, Carbon, 680 k $\Omega$ , ¼ W	99-213106
R624	Resistor, Carbon, 8.2 k $\Omega$ , ¼ W	99-213085
R625 ▲	Resistor, Carbon, 1 $\Omega$ , ¼ W	99-213053
R626	Resistor, Carbon, 4.7 k $\Omega$ , ¼ W	99-213078
R627	Resistor, Carbon, 15 k $\Omega$ , ¼ W	99-213059
R628	Potentiometer, Trimming, 50 k $\Omega$	99-213048
R636	Resistor, Metal Oxide, 1.5 k $\Omega$ , 2 W	99-213105
R637	Resistor, Carbon, 100 k $\Omega$ , ¼ W	99-213109
R701 ▲	Resistor, 1.8 $\Omega$ , 5 W	99-213104
R702	Resistor, Carbon, 33 k $\Omega$ , ¼ W	99-213070
R703 ▲	Resistor, Metal Oxide, 150 $\Omega$ , ½ W	99-213099
R704	Resistor, Metal Oxide, 330 $\Omega$ , 3 W	99-213101
R705	Resistor, Carbon, 56 k $\Omega$ , ¼ W	99-213082
R707	Potentiometer, Trimming, 1 k $\Omega$	99-213041
R708 ▲	Resistor, Carbon, 2.7 k $\Omega$ , ¼ W	99-213067
R709	Resistor, Carbon, 15 k $\Omega$ , ¼ W	99-213059
R710	Resistor, Carbon, 18 k $\Omega$ , ¼ W	99-213063
R711	Resistor, Carbon, 56 $\Omega$ , ¼ W	99-213107
R712	Resistor, Carbon, 560 $\Omega$ , ¼ W	99-213080
R801–R806	Resistor, Carbon, 180 $\Omega$ , ¼ W	99-213060
R807	Potentiometer, Trimming, 500 $\Omega$	99-213040
R808	Resistor, Carbon, 220 $\Omega$ , ¼ W	99-213061
R809	Potentiometer, Trimming, 500 $\Omega$	99-213040
R810–R812	Resistor, Carbon, 1 k $\Omega$ , ¼ W	99-213055
R813–R815	Potentiometer, Trimming, 5 k $\Omega$	99-213042
R816–R818	Resistor, Metal Oxide, 5.6 k $\Omega$ , 2 W	99-213095
R819–R821	Resistor, Solid, 3.3 k $\Omega$ , ½ W	99-213050
R822	Resistor, Carbon, 220 k $\Omega$ , ¼ W	99-213065
R825	Resistor, Solid, 470 $\Omega$ , ½ W	99-213052
<b>Transformers</b>		
T301	Transformer, Audio Output	99-213038
T601 ▲	Transformer, High-Voltage	99-213037
T602	Transformer, H-Drive	99-213039
T701	Transformer, Choke	99-213036
<b>Miscellaneous</b>		
F701 ▲	Fuse	99-213155
F702 ▲	Fuse	99-213154
L601 ▲	Coil, Size	99-213035
L602 ▲	Coil, Linearity	99-213034
L603 ▲	Yoke, Deflection	99-213033
L701 ▲	Coil, Line Filter	99-213031
L702 ▲	Coil, Degaussing	99-213032
SCR701	Rectifier	99-213008
▲	CRT, 19-Inch Color Standard-Resolution	99-213007

N O T E S



XM-2001N

**WARNING**

This product contains critical electrical and mechanical parts essential for X-ray radiation protection. For replacement purposes, use only type parts shown in the parts list. The **⚠** symbol and the shaded areas on this schematic diagram indicate parts essential for X-ray radiation and safety protection.

**Legend:**

**Resistor**

Unit: No indication— $\Omega$ , K—K $\Omega$ , M—M $\Omega$ . Tolerance: No indication— $\pm 10\%$ , J— $\pm 5\%$ . Power rating: No indication— $\frac{1}{4}$ W.

**Capacitor**

Unit: No indication or  $\mu$ — $\mu$ F, P—pF. Rated voltage: No indication—50V.

Some test points are without pins, and they are indicated by parentheses ( ).

Resistor		Capacitor	
No indication	Carbon film resistor	No indication	Ceramic capacitor
(C)	Solid resistor	ML	Mylar capacitor
(S)	Metal oxide film resistor	PF	Polypropylene film capacitor
(N)	Metal film resistor	TA	Tantalum capacitor
(W)	Cement resistor	ST	Styrol capacitor
(T)	Special resistor		

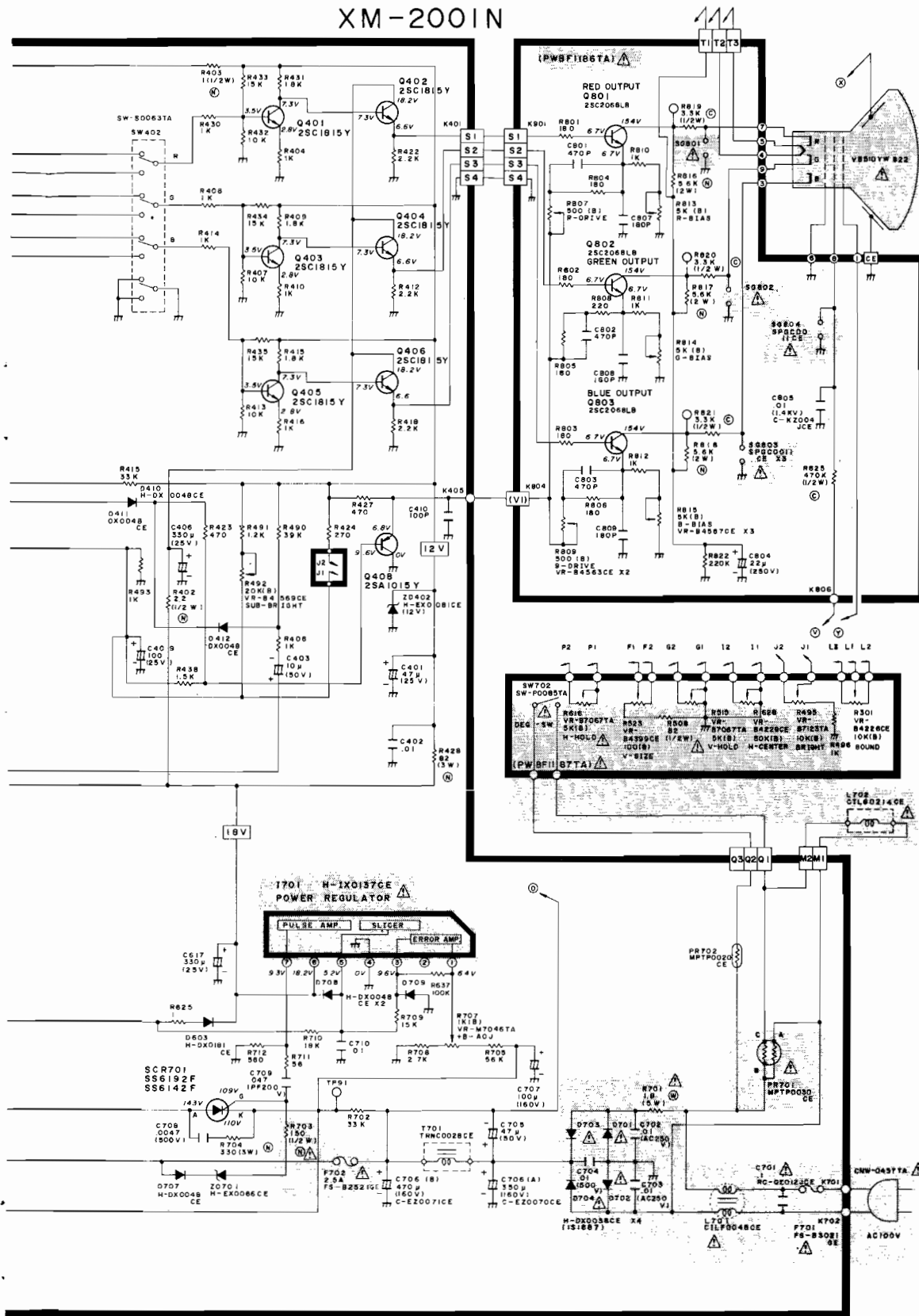


Figure 7 Sharp XM-2001N Video Display Schematic Diagram

# Warranty

Seller warrants that its printed-circuit boards and parts thereon are free from defects in material and workmanship under normal use and service for a period of ninety (90) days from date of shipment. Seller warrants that its video displays and laser video disc players (in games supplied with displays and video-disc players) are free from defects in material and workmanship under normal use and service for a period of thirty (30) days from date of shipment. None of the Seller's other products or parts thereof are warranted.

If the products described in this manual fail to conform to this warranty, Seller's sole liability shall be, at its option, to repair, replace, or credit Buyer's account for such products which are returned to Seller during said warranty period, provided:

- (a) Seller is promptly notified in writing upon discovery by Buyer that said products are defective;
- (b) Such products are returned prepaid to Seller's plant; and
- (c) Seller's examination of said products discloses to Seller's satisfaction that such alleged defects existed and were not caused by accident, misuse, neglect, alteration, improper repair, installation, or improper testing.

In no event shall Seller be liable for loss of profits, loss of use, incidental or consequential damages.

*Except for any express warranty set forth in a written contract between Seller and Buyer which contract supersedes the terms herein, this warranty is expressed in lieu of all other warranties expressed or implied, including the implied warranties of merchantability and fitness for a particular purpose, and of all other obligations or liabilities on the Seller's part, and it neither assumes nor authorizes any other person to assume for the Seller any other liabilities in connection with the sale of products by Seller.*

The use of any non-Atari parts may void your warranty, according to the terms of the warranty. The use of any non-Atari parts may also adversely affect the safety of your game and cause injury to you and others. Be very cautious in using non-Atari-supplied components with our games, in order to ensure your safety.

Atari distributors are independent, being privately owned and operated. In their judgment they may sell parts or accessories other than Atari parts or accessories. Atari Games Corporation cannot be responsible for the quality, suitability or safety of any non-Atari part or any modification including labor which is performed by such distributor.