

Bally

JULY 1995
16-10140

INDIANAPOLIS 500®

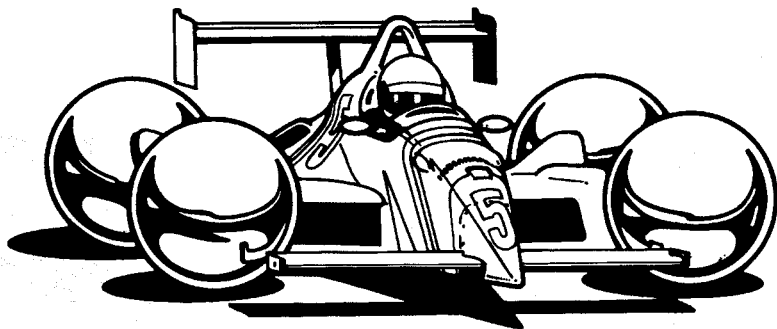

OPERATORS HANDBOOK

Midway Manufacturing Company, 3401 North California Avenue, Chicago, Illinois 60618

TABLE OF CONTENTS

MENU.....	1
LAMP MATRIX.....	2
LAMP LOCATIONS.....	3
SWITCH MATRIX	4
SWITCH LOCATIONS	5
SOLENOID TABLE	6
SOLENOID LOCATIONS.....	7
UPPER PLAYFIELD PARTS LIST.....	8
UPPER PLAYFIELD PARTS LOCATIONS.....	9
LOWER PLAYFIELD PARTS.....	10
RAMP PARTS.....	11
FUSE LIST	12
RUBBER RINGS.....	13

MENU SYSTEM OPERATION

The Main Menu allows you to choose from several categories, which in turn lead to other menus. To access the Main Menu, open the coin door and press the Begin Test button, then press the Enter button. Press the Up or Down buttons to cycle through the Main Menu. Press the Enter button to access a menu. Press the Escape button to return to the Main Menu. Press the Start button for HELP at any time.

Main Menu

B. Bookkeeping
Menu

B.1 Main Audits
B.2 Earnings Audits
B.3 Standard Audits
B.4 Feature Audits
B.5 Histograms
B.6 Time-Stamps

P. Printouts Menu

P.1 Earnings Data
P.2 Main Audits
P.3 Standard Audits
P.4 Feature Audits
P.5 Score Histograms
P.6 Game Time Histograms
P.7 Time-Stamps
P.8 All Data

T. Test Menu

T.1 Switch Edges
T.2 Switch Levels
T.3 Single Switches
T.4 Solenoid Test
T.5 Flasher Test
T.6 General Illumination
T.7 Sound & Music Test
T.8 Single Lamps
T.9 All Lamps
T.10 Lamp & Flasher Test
T.11 Display Test
T.12 Flipper Test
T.13 Ordered Lamp Test
T.14 Lamp Row-Col Test
T.15 Dip Switch Test
T.16 Turbo Test
T.17 Empty Balls Test

U. Utilities Menu

U.1 Clear Audits
U.2 Clear Coins
U.3 Reset H.S.T.D.
U.4 Set Time & Date
U.5 Custom Message
U.6 Set Game I.D.
U.7 Factory Adjustments
U.8 Factory Resets
U.9 Presets
U.10 Clear Credits
U.11 Auto Burn-In

A. Adjustments Menu

A.1 Standard Adjustments
A.2 Feature Adjustments
A.3 Pricing Adjustments
A.4 H.S.T.D. Adjustments
A.5 Printer Adjustments

Press Escape

To move out of a menu selection.

Press Enter

To get into a menu selection.

Press Up

Increases sequence; Example A.1, A.2, A.3, A.4.

Press Down

Decreases Sequence; Example A.4, A.3, A.2, A.1.

Use Up and Down to cycle through the selections in a menu.

Use Escape and Enter to move into and out of the selected menu

LAMP MATRIX

		Yellow (B+) →						Red	
Column	1	2	3	4	5	6	7	8	
Row	Yellow-Brown J137-1 Q90	Yellow-Red J137-2 Q98	Yellow-Orange J137-3 Q96	Yellow-Black J137-4 Q95	Yellow-Green J137-5 Q94	Yellow-Blue J137-6 Q93	Yellow-Violet J138-7 Q92	Yellow-Gray J138-9 Q91	
1	Red-Brown J133-1 Q90	LEFT LANE 11	TURBO LOCK 1 21	HIT THE "WALL" 31	SUPER JETS 41	DUELING DRIVERS 51	CHANGE SETUP 61	LIGHTUP 1 LOWER RIGHT 71	LIGHTUP 3 LOWER RIGHT 81
2	Red-Black J133-2 Q89	CENTER LANE 12	TURBO LOCK 2 22	HIT "THE" WALL 32	TURBO BOOST 42	SUPER LIGHTUPS 52	AWARD SPEEDWAY 62	LIGHTUP 1 UPPER RIGHT 72	LIGHTUP 3 UPPER RIGHT 82
3	Red-Orange J133-4 Q88	RIGHT LANE 13	TURBO LOCK 3 23	"HIT" THE WALL 33	CHECKERED FLAG 43	CAUTION FLAG 53	HIT THE WALL 63	LIGHTUP 1 UPPER LEFT 73	LIGHTUP 3 UPPER LEFT 83
4	Red-Yellow J133-5 Q87	UPPER EJECT TOP 14	LIGHT LOCK LAMP 24	LEFT RAMP JACKPOT 34	GO FOR THE POLE 44	EXTRA BALL FLAG 54	RIGHT RAMP JACKPOT 64	LIGHTUP 1 LOWER LEFT 74	LIGHTUP 3 LOWER LEFT 84
5	Red-Green J133-6 Q86	JET WRENCH 15	LIGHT SPEEDWAY 25	INCREASE BOOST 35	QUICK PIT 45	WRONG TURN 55	PIT STOP 65	LIGHTUP 2 LOWER RIGHT 75	NOT USED 85
6	Red-Blue J133-7 Q85	EXTRA BALL 16	"PASS" 26	SOUVENIR LAMP 36	3X PLAYFIELD 46	GASOLINE ALLEY 56	FAST LAPS 66	LIGHTUP 2 UPPER RIGHT 76	LAUNCH BUTTON 85
7	Red-Violet J133-8 Q84	VICTORY LAP 17	LEFT RAMP WRENCH 27	LEFT FLIPPER LANE 37	UPPER RIGHT FLIPPER WRENCH 47	RIGHT OUTLANE 57	NOT USED 67	LIGHTUP 2 UPPER LEFT 77	BUY-IN BUTTON 87
8	Red-Gray J133-9 Q83	TURBO WRENCH 18	LEFT RAMP STANDUP 28	LEFT OUTLANE 38	RIGHT FLIPPER LANE 48	SHOOT AGAIN 58	NOT USED 68	LIGHTUP 2 LOWER LEFT 78	START BUTTON 88

J1XX = Power Driver Board

LAMP LOCATIONS

Item No.	Bulb No.	Lamp Assy. No.	Description	Item No.	Bulb No.	Lamp Assy. No.	Description
11	24-8768	A-20108	Left Lane	35	24-8768	A-20105	Increase Boost
12	24-8768	A-20108	Center Lane	36	24-8768	A-20105	Souvenir Lamp
13	24-8768	A-20108	Right Lane	37	24-6549	A-17835	Left Flipper Lane
14	24-8768	A-20104	Upper Eject Top	38	24-6549	A-17835	Left Outlane
15	24-8768	A-20104	Jet Wrench	41	24-8768	A-20103	Super Jets
16	24-8768	A-20104	Extra Ball	42	24-8768	A-20103	Turbo Boost
17	24-8768	A-20104	Victory Lap	43	24-8768	A-20103	Checkedered Flag
18	24-6549	A-17835	Left Ramp Wrench	44	24-8768	A-20103	Go For The Pole
21	24-8768	A-20107	Turbo Lock 1	45	24-8768	A-20103	Quick Pit
22	24-8768	A-20107	Turbo Lock 2	46	24-8768	A-20103	3X Playfield
23	24-8768	A-20107	Turbo Lock 3	47	24-6549	A-17835	Upper Right Flipper Wrench
24	24-8768	A-20105	Light Lock Lamp	48	24-6549	A-17835	Right Flipper Lane
25	24-8768	A-20105	Light Speedway	51	24-8768	A-20103	Dueling Drivers
26	24-8768	A-20105	"Pass"	52	24-8768	A-20103	Super Lightups
27	24-6549	A-17835	Turbo Wrench	53	24-8768	A-20103	Caution Flag
28	24-6549	A-17835	Left Ramp Standup	54	24-8768	A-20103	Extra Ball Flag
31	24-8768	A-20106	Hit The "Wall"	55	24-8768	A-20103	Wrong Turn
32	24-8768	A-20106	Hit "The" Wall	56	24-8768	A-20103	Gasoline Alley
33	24-8768	A-20106	"Hit" The Wall	57	24-6549	A-17835	Right Outlane
34	24-8768	A-20105	Left Ramp Jackpot	58	24-6549	A-17835	Shoot Again

LAMP LOCATIONS CONTINUED

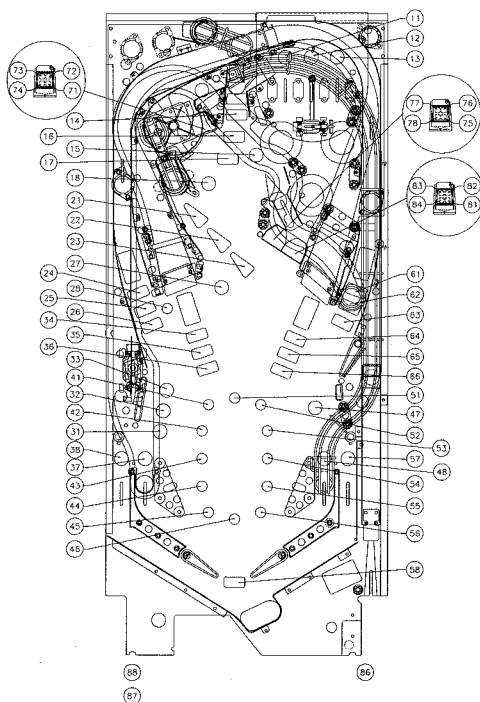

Item No.	Bulb No.	Lamp Assy. No.	Description	Item No.	Bulb No.	Lamp Assy. No.	Description
61	24-8768	A-20105	Change Setup	75	---	A-19823	Lightup 2 Lower Right
62	24-8768	A-20105	Award Speedway	76	---	A-19823	Lightup 2 Upper Right
63	24-8768	A-20105	Hit The Wall	77	---	A-19823	Lightup 2 Upper Left
64	24-8768	A-20105	Right Ramp Jackpot	78	---	A-19823	Lightup 2 Lower Left
65	24-8768	A-20105	Pit Stop	81	---	A-19823	Lightup 3 Lower Right
66	24-8768	A-20105	Fast Laps	82	---	A-19823	Lightup 3 Upper Right
67	---	---	Not Used	83	---	A-19823	Lightup 3 Upper Left
68	---	---	Not Used	84	---	A-19823	Lightup 3 Lower Left
71	---	A-19823	Lightup 1 Lower Right	85	---	---	Not Used
72	---	A-19823	Lightup 1 Upper Right	86	---	20-9663-B-3	Launch Button
73	---	A-19823	Lightup 1 Upper Left	87	---	20-9663-21	Buy-In Button
74	---	A-19823	Lightup 1 Lower Left	88	---	20-9663-1	Start Button

24-8768 = #555 Bulb
24-6549 = #44 Bulb

SWITCH MATRIX

White → | | ← Green

Dedicated Grounded Switches	Column Row	1	2	3	4	5	6	7	8	Flipper Grounded Switches	
		Green-Brown J207-1 U20-18	Green-Red J207-2 U20-17	Green-Orange J207-3 U20-16	Green-Yellow J207-4 U20-15	Green-Black J207-5 U20-14	Green-Blue J207-6 U20-13	Green-Violet J207-7 U20-12	Green-Gray J207-9 U20-11		
Orange-Brown (1) J205-1 Left Coin Chute D1	1	White-Brown J209-1 U18-11	BALL LAUNCH	SLAM TILT	THREE BANK CENTER	TOP TROUGH	LEFT LANE	UPPER POPPER	NOT USED	NOT USED	Black-Green J906-1 Right Flipper EOS
Orange-Red (2) J205-2 Center Coin Chute D2	2	White-Red J209-2 U18-9	NOT USED	COIN DOOR CLOSED	THREE BANK LOWER	TROUGH 1 (RIGHT)	CENTER LANE	TURBO POPPER	LEFT JET	NOT USED	Black-Violet J905-1 Right Flipper Opto
Orange-Black (3) J205-3 Right Coin Chute D3	3	White-Orange J209-3 U18-5	START BUTTON	BUY-IN BUTTON	NOT USED	TROUGH 2	RIGHT LANE	TURBO BALL SENSE	RIGHT JET	NOT USED	Black-Blue J906-2 Left Flipper EOS
Orange-Yellow (4) J205-4 4th Coin Chute D4	4	White-Yellow J209-4 U18-7	PLUMB BOB TILT	ALWAYS CLOSED	RIGHT FLIPPER WRENCH	TROUGH 3	TEN POINT	UPPER EJECT	CENTER JET	NOT USED	Black-Gray J905-2 Left Flipper Opto
Orange-Green (5) J205-6 Normal Function Ser Credits Esc D5	5	White-Green J209-5 U19-11	LEFT OUTLANE	SHOOTER LANE	LEFT RAMP ENTER	TROUGH 4 (LEFT)	LEFT RAMP WRENCH	LOWER KICKER	RIGHT RAMP ENTER	NOT USED	Black-Violet J906-4 Upper Right Flipper EOS
Orange-Blue (6) J205-7 Normal Function Vol Down D6	6	White-Blue J209-7 U19-9	LEFT FLIPPER LANE	LEFT SLING-SHOT	LEFT RAMP MADE	LEFT RAMP STANDUP	LEFT LIGHTUP	TURBO INDEX	RIGHT RAMP MADE	NOT USED	Black-Yellow J906-3 Upper Right Flipper Opto
Orange-Violet (7) J205-8 Normal Function Vol Up D7	7	White-Violet J209-8 U19-5	RIGHT FLIPPER LANE	RIGHT SLING-SHOT	LEFT LOOP	TURBO WRENCH	CENTER LIGHTUP	NOT USED	NOT USED	NOT USED	Black-Gray J906-5 Upper Left Flipper EOS
Orange-Gray (8) J205-9 Normal Function Begin Test Enter D8	8	White-Gray J209-9 U19-7	RIGHT OUTLANE	THREE BANK UPPER	RIGHT LOOP	JET BUMPER WRENCH	RIGHT LIGHTUP	NOT USED	NOT USED	NOT USED	Black-Blue J905-5 Upper Left Flipper Opto

J2XX = CPU Board; J9XX = Fliptronic II Board; [Pattern] = Opto, Typically Closed

SWITCH LOCATIONS

Item No.	Switch Part No.	Description	Item No.	Switch Part No.	Description
F1	SW-1A-194	Lower Right Flipper EOS	27	SW-1A-114	Right Slingshot (Kicker)
F2	A-17316	*Lower Right Flipper Cabinet	SW-1A-120		(Score)
F3	SW-1A-194	Lower Left Flipper EOS	28	A-18019-20	Three Bank Upper
F4	A-17316	*Lower Left Flipper Cabinet	31	A-18019-20	Three Bank Center
F5	SW-1A-194	Upper Right Flipper EOS	32	A-18019-20	Three Bank Lower
F6	A-17316	* Upper Right Flipper Cabinet	33	---	Not Used
F7	---	Not Used	34	A-18019-6	Right Flipper Wrench
F8	---	Not Used	35	5647-12693-11	Left Ramp Enter
11	20-9663-B-3	Ball Launch	36	5647-12693-11	Left Ramp Made
12	---	Not Used	37	5647-12693-19	Left Loop
13	20-9663-1	Start Button	38	5647-12693-19	Right Loop
14	A-15361	*Plumb Bob Tilt	41	A-18617-1	Top Trough (LED)
15	5647-12693-19	Left Outlane	A-18618-1		(Transistor)
16	5647-12693-19	Left Flipper Lane	42	A-18617-1	Trough 1 (Right) (LED)
17	5647-12693-19	Right Flipper Lane	A-18618-1		(Transistor)
18	5647-12693-19	Right Outlane	43	A-18617-1	Trough 2(LED)
21	A-17238	*Slam Tilt	A-18618-1		(Transistor)
22	5643-09288-00	*Coin Door Closed	44	A-18617-1	Trough 3(LED)
23	20-9663-21	Buy-In Button	A-18618-1		(Transistor)
24	5643-09112-00	*Always Closed	45	A-18617-1	Trough 4 (Left) (LED)
25	5647-12693-32	Shooter Lane	A-18618-1		(Transistor)
26	SW-1A-114	Left Slingshot (Kicker)	46	A-18530-1	Left Ramp Standup
	SW-1A-120	(Score)	47	A-18019-6	Turbo Wrench
			48	A-18019-6	Jet Bumper Wrench

*Not Shown

SWITCH LOCATIONS CONTINUED

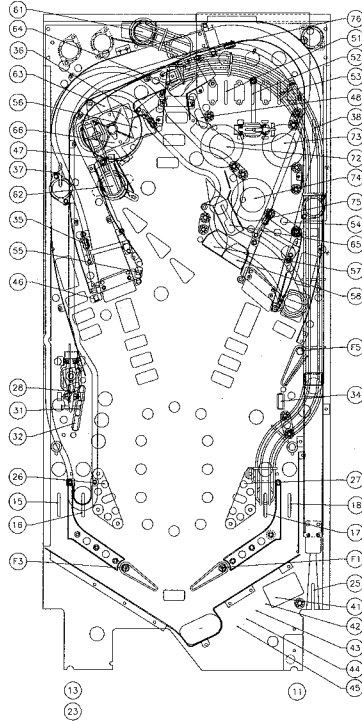

Item No.	Switch Part No.	Description	Item No.	Switch Part No.	Description
51	5647-12693-19	Left Lane	71	---	Not Used
52	5647-12693-19	Center Lane	72	SW-11A-37-1	Left Jet
53	5647-12693-19	Right Lane	73	SW-11A-37-1	Right Jet
54	SW-1A-120	Ten Point	74	SW-11A-37-1	Center Jet
55	A-18017-6	Left Ramp Wrench	75	5647-12693-11	Right Ramp Enter
56	A-19823	Left Lightup	76	5647-12693-11	Right Ramp Made
57	A-19823	Center Lightup	77	---	Not Used
58	A-19823	Right Lightup	78	---	Not Used
61	A-16908	Upper Popper	81	---	Not Used
	A-16909		82	---	Not Used
62	A-16908	Turbo Popper	83	---	Not Used
	A-16909		84	---	Not Used
63	A-14231	Turbo Ball Sense	85	---	Not Used
	A-14232		86	---	Not Used
64	5647-12133-11	Upper Eject	87	---	Not Used
65	5647-12693-63	Lower Kicker	88	---	Not Used
66	A-20047	Turbo Index			
67	---	Not Used			
68	---	Not Used			

*Not Shown

SOLENOID/FLASHER TABLE

Sol. No.	Function	Solenoid Type	Voltage Connections			Drive Xister	Drive Connections			Drive Wire Color	Solenoid Part number Flashlamp Type	
			Playfield	Backbox	Cabinet		Playfield	Backbox	Cabinet		Playfield	Backbox
01	Auto Plunger	High Power	J107-2			Q82	J130-1			Vio-Brn	AE-23-800	
02	Upper Popper	High Power	J107-2			Q80	J130-2			Vio-Red	AE-24-900	
03	Upper Eject	High Power	J107-2			Q78	J130-4			Vio-Org	AE-26-1200	
04	Lower Eject	High Power	J107-2			Q76	J130-5			Vio-Yel	AE-28-1500	
05	Turbo Popper	High Power	J107-2			Q64	J130-6			Vio-Grn	AE-24-900	
06	Not Used	High Power				Q66					---	
07	Knocker	High Power		J107-2		Q68		J130-8		Vio-Blk		AE-23-800
08	Left Jet	High Power	J107-2			Q70	J130-9			Vio-Gry	AE-26-1200	
09	Right Jet	Low Power	J107-3			Q58	J127-1			Brn-Blk	AE-26-1200	
10	Center Jet	Low Power	J107-3			Q56	J127-3			Brn-Red	AE-26-1200	
11	Left Sling	Low Power	J107-3			Q54	J127-4			Brn-Org	AE-26-1200	
12	Right Sling	Low Power	J107-3			Q52	J127-5			Brn-Yel	AE-26-1200	
13	Trough	Low Power	J107-3			Q50	J127-6			Brn-Grn	AE-26-1500	
14	Upper Popper Flasher	Low Power	J107-6			Q48	J127-7			Brn-Blu	#906	
15	Top Left Corner Flasher	Low Power	J107-6			Q46	J127-8			Brn-Vio	#906	
16	Top Right Corner Flasher	Low Power	J107-6			Q44	J127-9			Brn-Gry	#906	
17	Turbo Motor	Flasher	J116-2			Q42	J126-1			Blk-Brn	14-8021.1	
18	Race Track Motor	Flasher	J116-2			Q40	J126-2			Blk-Red	14-8022	
19	Orange Car Flasher	Flasher	J107-6			Q38	J126-3			Blk-Org	#906	
20	Yellow Car Flasher	Flasher	J107-6			Q36	J126-4			Blk-Yel	#906	
21	Blue Car Flasher	Flasher	J107-6			Q28	J126-5			Blu-Grn	#906	
22	Green Car Flasher	Flasher	J107-6			Q30	J126-6			Blu-Blk	#906	
23	Left Jet Flasher	Flasher	J107-6			Q34	J126-7			Blu-Vio	#906	
24	Right Jet Flasher	Flasher	J107-6			Q32	J126-8			Blu-Gry	#906	
25	Center Jet Flasher	Gen. Purpose	J107-6			Q26	J122-1			Blu-Brn	#906	
26	Right Side Flasher	Gen. Purpose	J107-6			Q24	J122-2			Blu-Red	#906	
27	Left Side Flasher (2)	Gen. Purpose	J107-6			Q22	J122-3			Blu-Org	#906 (2)	
28	Right Ramp Enter Flasher	Gen. Purpose	J107-6			Q20	J122-4			Blu-Yel	#906	
35	Diverter Power	High Power	J907-8,9			Q1	J802-3			Yel-Gry	A-20099	
36	Diverter Hold	Low Power	J907-8,9			Q5	J802-1			Org-Gry	A-20099	

General Illumination												
Sol. No.	Function	Solenoid Type	J121-1	J120-1	J121-2	J120-2	J121-3	J120-3	J121-4	J120-4	J121-5	J120-5
01	Upper Left Playfield	G.I.	J121-1	J120-1					Q18	J121-7	J120-7	
02	Upper Right Playfield	G.I.	J121-2						Q10	J121-8		
03	Lower Playfield	G.I.	J121-3	J120-3					Q14	J121-9	J120-9	
04	Backbox-Coindoor	G.I.		J120-5					Q16		J120-10	
05	Backbox Title	G.I.		J120-6					Q12		J120-11	

Flipper Circuits												
Sol. No.	Function	Solenoid Type	Voltage Connections		Drive Transistors		Drive Connectors		Drive Wire Colors		Coil Part No.	Coil Color
			Playfield	Power	Power	Hold	Playfield	Power	Power	Hold		
29	Lower Right Flipper	Lwr. Rt. Power	J907-1 (Red-Grn)		Q4		J902-13	Yel-Grn				
30	Lower Right Flipper	Lwr. Rt. Hold	J907-1 (Red-Grn)			Q11	J902-11		Org-Grn		FL-11629	BLUE
31	Lower Right Flipper	Lwr. Lt. Power	J907-4 (Red-Blu)		Q3		J902-9	Yel-Blu				
32	Lower Left Flipper	Lwr. Lt. Hold	J907-4 (Red-Blu)			Q9	J902-7		Org-Blu		FL-11629	BLUE
33	Upper Right Flipper	Upr. Rt. Power	J907-6 (Red-Vio)		Q2		J902-6	Yel-Vio				
34	Upper Right Flipper	Upr. Rt. Hold	J907-6 (Red-Vio)			Q7	J902-4		Org-Vio		FL-11629	BLUE
35	Upper Left Flipper	Upr. Lt. Power	J907-8 (Red-Gry)		Q1		J902-3	Yel-Gry				
36	Upper Left Flipper	Upr. Lt. Hold	J907-8 (Red-Gry)			Q5	J902-1		Org-Gry		SEE	ABOVE

J1xx=Power Driver Board; J9xx=Fliptronic II Board; 24-6549=#44 bulb; 24-8704=#89 bulb; 24-8768=#555 bulb; 24-8802=#906 bulb

SOLENOID/FLASHER LOCATIONS

Item No.	Coil/Flasher No.	Assy. Number.	Description	Item No.	Coil/Flasher No.	Assy. Number.	Description
01	AE-23-800	A-14525	Auto Plunger	11	AE-26-1200	B-9362-L-2	Left Sling
02	AE-24-900	A-20235	Upper Popper	12	AE-26-1200	A-9362-R-3	Right Sling
03	AE-26-1200	B-9361-R-1	Upper Eject	13	AE-26-1500	A-19963	Trough
04	AE-28-1500	A-20451	Lower Eject	14	24-8802	A-19980	Upper Popper Flasher
05	AE-24-900	A-20159	Turbo Popper	15	24-8802	A-19980	Top Left Corner Flasher
06	---	---	Not Used	16	24-8802	A-19980	Top Right Corner Flasher
07	AE-23-800	B-10686-1	*Knocker	17	14-8021	A-20038	Turbo Motor
08	AE-26-1200	A-9415-2	Left Jet	18	14-8022	A-20169	Race Track Motor
09	AE-26-1200	A-9415-2	Right Jet	19	24-8802	A-17802	Orange Car
10	AE-26-1200	A-9415-2	Center Jet	20	24-8802	A-17802	Yellow Car

*NOT SHOWN

SOLENOID/FLASHER LOCATIONS CONTINUED

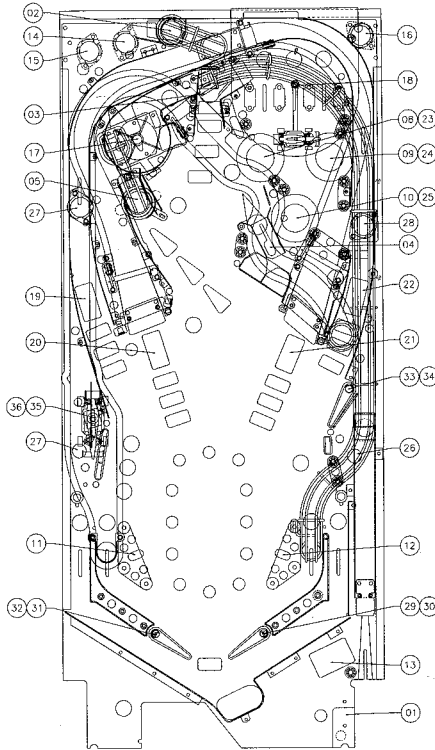

Item No.	Coil/Flasher No.	Assy. No.	Description	<u>General Illumination Circuits</u>		
				Item No.	Description	Bulb No.
21	24-8802	A-17802	Blue Car	01	Upper Left Playfield	G.I. String 1
22	24-8802	A-17802	Green Car	02	Upper Right Playfield	G.I. String 2
23	24-8802	A-20432-5	Left Jet Flasher	03	Lower Playfield	G.I. String 3
24	24-8802	A-20432-5	Right Jet Flasher	04	Backbox-Coindoor	G.I. String 4
25	24-8802	A-20432-5	Center Jet Flasher	05	Backbox Title	G.I. String 5
26	24-8802	C-13337	Right Side Flasher			
27	24-8802	C-13337	Left Side Flasher (2)			
28	24-8802	A-19979	Right Ramp Enter Fls.			
35	A-20099	A-19978	Diverter Power			
36	A-20099	A-19978	Diverter Hold			
				<u>Flipper Coils</u>		
Item No.	Coil No.	Color	Assy. No.	Description		
29 & 30	FL-11629	Blue	A-15849-R-2	Lower Right Flipper		
31 & 32	FL-11629	Blue	A-15849-L-2	Lower Left Flipper		
33 & 34	FL-11629	Blue	A-14876-R-3	Upper Right Flipper		
				24-6549 = #44 bulb		
				24-8704 = #89 bulb		
				24-8768 = #555 bulb		
				24-8802 = #906 bulb		

UPPER PLAYFIELD PARTS

Item No.	Part Number	Description	Item No.	Part Number	Description
1	01-9211	*Playfield Hanger Bracket	42	02-4250-36	Spacer 6-32 x 2 1/4"
2	01-13593	Bottom Arch Ball Guide	44	A-17794	Kicker Switch Sub-Assembly
3	A-15849-L-2	Flipper Assembly Complete	45	A-20406	Switch & Bracket Assembly
	20-10110-5	Flipper & Shaft Assy., White		A-20451	Coil & Bracket Assembly
4	03-9216-13	Flipper Return Guide, Clear		A-20450	Kicker Assembly, Left
5	A-17813	Rollover Switch Assembly		10-128	Spring
6	A-17811	Sling Shot Kicker Assembly	46	04-10044	Ball Guide Assembly
	B-9362-L-2	Coil & Bracket Assembly	47	01-13840	Ball Guide
	10-128	Spring	48	12-7293.1	Wire Ramp Support Bracket
7	A-17801	Kicker Count Switch	49	A-14876-R-3	Flipper Assembly Complete
8	02-5107	Adjusting Post		20-10110-5	Flipper & Shaft Assy., White
9	A-19980	Pit Ramp Assembly	50	02-4765-6	Mounting Post 3.13"
10	A-18019-20	Stationary Target, Orange	51	12-7273.2	Turbo Exhaust Ramp
11	A-19978	*Pit Ramp Diverter Assembly	52	04-10058	Ball Guide
	A-20413	Diverter Blade & Car Assembly	53	A-20410	Shooter Ramp Assembly
12	A-18159	*10 Opto P.C.B. Assembly	54	A-17811	Sling Shot Kicker Assembly
13	01-13842	Ball Guide		B-9362-R-3	Coil & Bracket Assembly
14	A-18530-1	Stationary Target, Blue		10-128	Spring
15	A-18017-6	Stationary Target, Yellow	55	A-15802-P	Level & Holder Assembly
16	A-19979	Serpentine Ramp Assembly	56	A-15849-R-2	Flipper Assembly Complete
17	01-13843	Ball Guide		20-10110-5	Flipper & Shaft Assy., White
18	A-20407	Turbo Feed Wire Ramp Assy.	57	01-10621	Strike Plate
19	12-6466-10	Ball Guide Wire 2 1/2"	58	A-19963	Ball Trough Assembly, Complete
20	A-20159	Ball Popper Assembly	59	A-18973	Shooter Lane Switch Assembly
21	02-4765-18	Mounting Post 2.41"	60	A-14525	Kicker Bracket Assembly
22	A-18019-6	Stationary Target, Yellow	61	01-13931.1	Left Guard
23	01-14002	Ball Guide	62	01-13932.1	Right Guard
24	01-13912.1	Ball Guide	63	01-13933.1	Left Guard
25	A-20038	Turbo Motor Assembly	64	01-13934.1	Right Guard
	A-20065	Turbo Housing Assembly	65	01-14088	Kicker Ball Guide, Left
	03-9343	Turbo Impeller	66	01-10489	Kicker Ball Guide, Right
26	A-19820-1	Illuminated Target Assembly	67	A-20524	One-way Gate Assembly
	A-20401	Illuminated Target P.C.B. & Brkt.			
27	02-4765-17	Mounting Post 2.25"	NOT SHOWN:		
28	04-10203	Ball Guide Assembly	01-12569		Gusset Brackets
29	12-6466-6A	Ball Guide Wire 1 5/8"	03-9418-1A		**Full Playfield Mylar
30	A-20180	Ball Stop Assembly	03-9418-2		Drop Area Mylar (2)
31	A-20235	Ball Popper Assembly	03-9418-3		Upper Left Area Mylar
32	12-7282	Rear Wire Ramp	03-9418-4		Jet Bumper Area Mylar
33	A-20433	One-way Gate Assembly	03-9418-5		Upper Mylar
34	03-8318-9	Double Sided Light Hood, Red	A-15542		Motor EMI P.C.B.
35	A-20170	Back Panel Assembly	A-17812-2		Cable Mounting Bracket 1/2"
36	A-17985-R	Eject Switch Assembly	A-17812-4		Cable Mounting Bracket 1"
	B-9361-R-1	Ball Eject Assembly, Left	A-20189		Motor EMI w/Delay Brake P.C.B.
	B-9362-R-3	Coil & Bracket Assembly	A-20501		Playfield Plastic Assy.
	10-128	Spring	36-50026		Screened Playfield
37	04-10201	Metal Shooter Ramp	MISCELLANEOUS:		
38	A-20169	Race Track Assembly	01-11791		Service Switch Actuator
39	02-4250-48	Spacer 6-32 x 3"	23-6767		Bulb Extractor
40	12-6466-5	Ball Guide Wire 1 1/4"			
41	A-9415-2	Jet Bumper Coil Assembly	*Located under playfield.		
	A-12030-3	Jet Bumper Switch Assembly	**The Indianapolis 500 hardcoat playfield does not require a full mylar. However, mylars can be purchased through your local Bally Distributor.		
	A-20432-5	Jet Bumper Wafer Assy., Orange			
	03-9266-12	Jet Bumper Cap, Orange			
	03-9267-9	Jet Bumper Dome, Red			
	23-6710-1	Clear Tubing #10, 1"			

UPPER PLAYFIELD PARTS

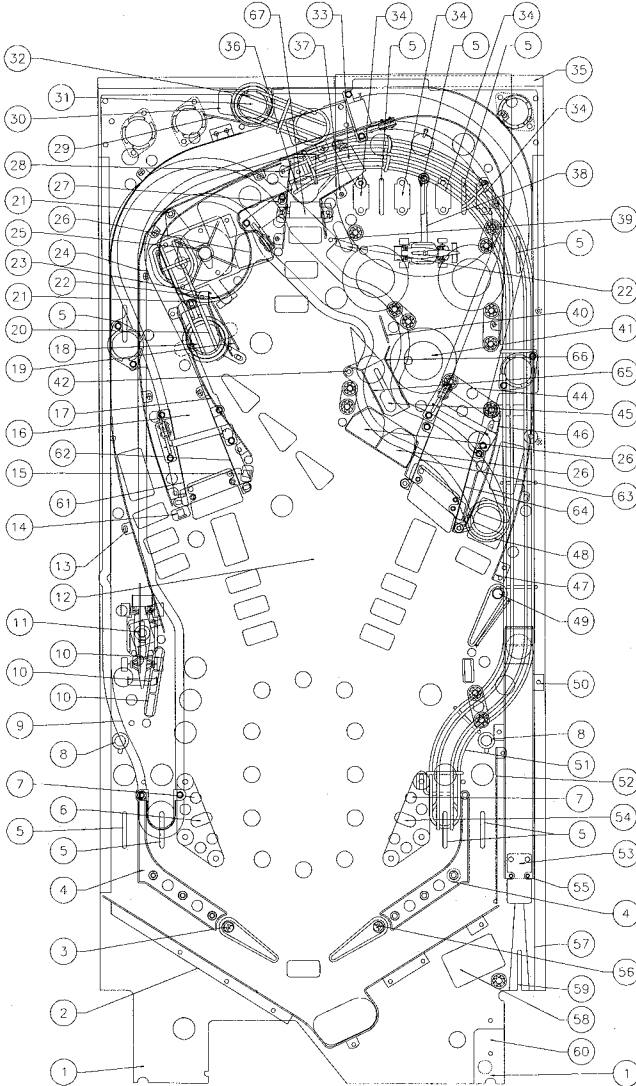

LOWER PLAYFIELD PARTS

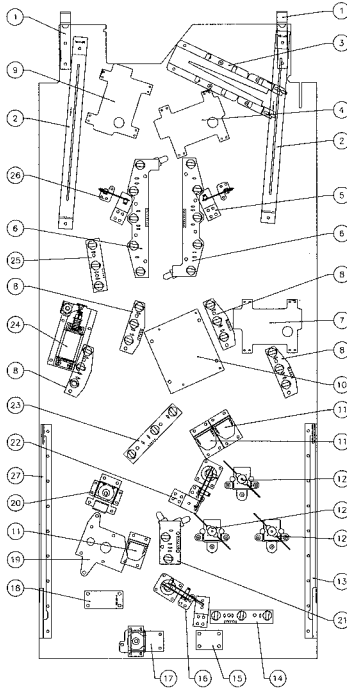

Item Part Number Description.
No.

- | | | |
|----|-------------|---------------------------------|
| 1 | 01-9211 | Playfield Hanger Bracket |
| 2 | 01-11781 | Leg Support |
| 3 | A-19963 | Outhole Ball Trough Assy. |
| 4 | A-15849-R-2 | Flipper Assembly, Right |
| 5 | A-17811 | Kicker Arm (Slingshot) Assy. |
| | B-9362-R-3 | Coil & Bracket Assembly |
| | 10-128 | Spring |
| 6 | A-20103 | 6 Lamp P.C.B. Assy. |
| 7 | A-14876-R-3 | Flipper Assembly, Right |
| 8 | A-20105 | 3 Lamp P.C.B. Assembly |
| 9 | A-15849-L-2 | Flipper Assembly, Left |
| 10 | A-18159 | 10-Opto P.C.B. Assembly |
| 11 | A-19820-1 | Illuminated Target Assembly |
| | A-20401 | Illum. Target P.C.B. & Brkt. |
| 12 | A-9415-2 | Jet Bumper Coil Assembly |
| 13 | A-17949.1-2 | Playfield Slide Assembly, Right |
| 14 | A-20108 | 3 Lamp P.C.B. Assembly |
| 15 | A-15542 | Motor EMI P.C.B. Assembly |

Item Part Number Description.
No.

- | | | |
|----|-------------|--------------------------------|
| 16 | B-9361-R-1 | Ball Eject Assembly, Left |
| | B-9362-R-3 | Coil & Bracket Assembly |
| 17 | A-20235 | Ball Popper Assembly |
| 18 | A-20189 | EMI Motor w/Delay Brake PCB |
| 19 | A-20038 | Turbo Motor Assembly |
| 20 | A-20159 | Ball Popper Assembly |
| 21 | A-20104 | 4 Lamp P.C.B. Assembly |
| 22 | A-20450 | Kicker Assembly, Left |
| | A-20451 | Coil & Bracket Assembly |
| | 10-128 | Spring |
| 23 | A-20107 | 3 Lamp P.C.B. Assembly |
| 24 | A-19978 | Pit Ramp Diverter Assembly |
| 25 | A-20106 | 3 Lamp P.C.B. Assembly |
| 26 | A-17811 | Kicker Arm (Slingshot) Assy. |
| | B-9362-L-2 | Coil & Bracket Assembly |
| 27 | A-17949.1-1 | Playfield Slide Assembly, Left |

RAMPS

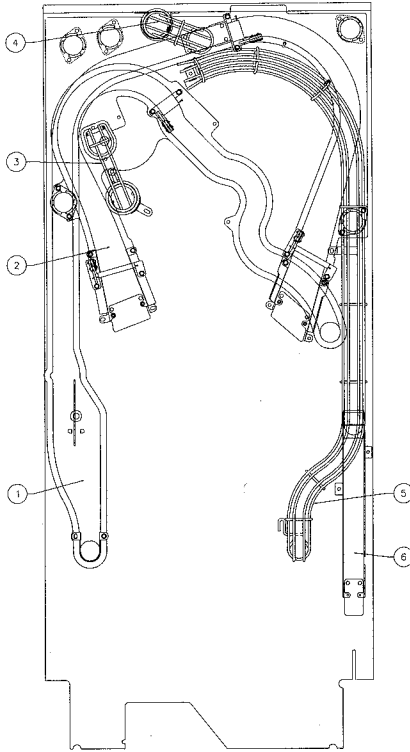

Item No.	Part Number	Description.	Item No.	Part Number	Description.
1	A-19980	Pit Ramp Assembly	2	A-19979	Serpentine Ramp Assembly
	03-9339.1	Pit Entrance Ramp (plastic only)		03-9341.3	Serpentine Ramp (plastic only)
	03-9340.1	Pit Exit Ramp (plastic only)		A-17516	Switch & Gate Assembly
	A-17516	Switch & Gate Assembly		A-20440	Gate Switch Assembly
	A-20440	Gate Switch Assembly		03-8171-9	Mini Dome, Red
	01-13917.1	Ball Guard Bracket		A-14265-13	Receptacle & Socket, Clear
	A-14265-13	Receptacle & Socket, Clear	3	A-20407	Turbo Feed Wire Assembly
	03-8171-9	Mini Dome, Red		12-7272.2	Turbo Feed (wire ramp only)
	03-8171-10	Mini Dome, Blue		23-8686	Round Pad
	03-8171-16	Mini Dome, Yellow	4	12-7282	Ball Popper Wire Ramp
			5	12-7273	Turbo Exhaust Ramp
			6	A-20410	Shooter Ramp Assembly

Fuse List

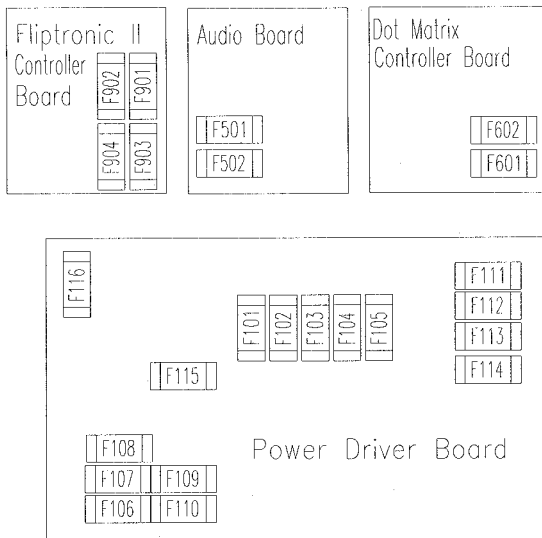

Audio Board

F501 -25V Circuit 3A, 250V, S.B.
 F502 +25V Circuit 3A, 250V, S.B.

Dot Matrix Controller Board

F601 +62V Circuit 3/8A, 250V, F.B.
 F602 -113V and -125V Circuits 3/8A, 250V, F.B.

Fliptronic II Controller Board

F901 Lower Right Flipper 3A, 250V, S.B.
 F902 Lower Left Flipper 3A, 250V, S.B.
 *F903 Upper Right Flipper 3A, 250V, S.B.
 *F904 Upper Left Flipper 3A, 250V, S.B.

Power Driver Board

F101 +50VDC General (Not Used) 3A, 250V, S.B.
 F102 +50VDC General (Not Used) 3A, 250V, S.B.
 F103 Solenoid #25-#28 3A, 250V, S.B.
 F104 Solenoid #9-#16 3A, 250V, S.B.
 F105 Solenoid #1-#8 3A, 250V, S.B.
 F106 G.I. #5 Wht-Vio 5A, 250V, S.B.
 F107 G.I. #4 Wht-Grn 5A, 250V, S.B.
 F108 G.I. #3 Wht-Yel 5A, 250V, S.B.
 F109 G.I. #2 Wht-Org 5A, 250V, S.B.
 F110 G.I. #1 Wht-Brn 5A, 250V, S.B.
 F111 Flasher Secondary 5A, 250V, S.B.
 F112 Solenoid Secondary 7A, 250V, S.B.
 F113 +5V Logic 5A, 250V, S.B.
 F114 +18V Lamp Matrix 8A, 32V, N.B.
 F115 +12V Switch Matrix 3/4A, 250V, F.B.
 F116 +12V Secondary 3A, 250V, S.B.

Line Filter

Domestic Game 8A
 Foreign Game 5A, S.B.

*May be used for circuits other than flipper circuits.

RUBBER RINGS

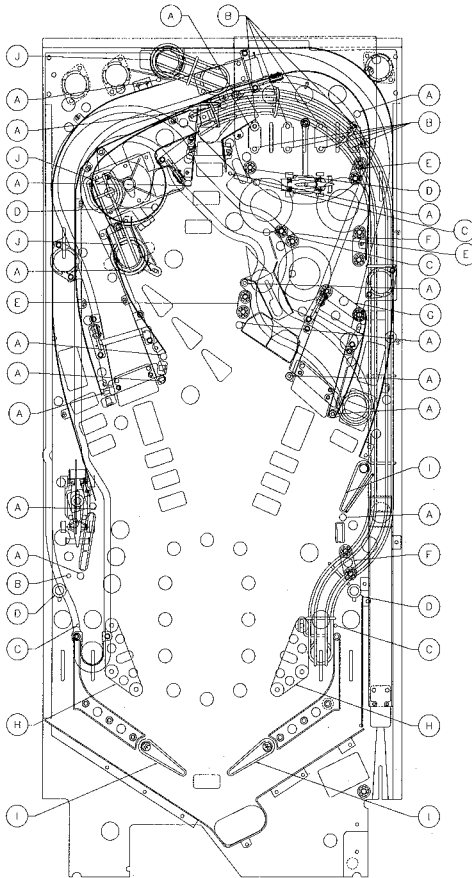

Item No.	Part Number	Description.	Qty	Item No.	Part Number	Description.	Qty
A	23-6556	Black Sleeve	17	F	23-6694-6	Rubber Ring 1"	2
B	23-6641	Rubber Bumper .64 od	9	G	23-6694-8	Rubber Ring 1 1/2"	1
C	23-6694-1	Rubber Grommet 3/32"	4	H	23-6694-10	Rubber Ring 2 1/2"	2
D	23-6694-3	Rubber Ring 5/16"	6	I	23-6695	Flipper Ring 1 1/2"	3
E	23-6694-5	Rubber Ring 3/4"	3	J	23-6686	Round Pad, Blue	3

WARNINGS & NOTICES

WARNING

FOR SAFETY AND RELIABILITY, substitute parts and equipment modifications are not recommended. Use of Non-BALLY parts or modifications of game circuitry, may adversely affect game play, or may cause injuries.

SUBSTITUTE PART OR EQUIPMENT MODIFICATIONS may void FCC Type Acceptance.

BECAUSE THIS GAME IS PROTECTED by Federal copyright, trademark, and patent laws, unauthorized game conversions may be illegal under Federal law.

THIS 'CONVERSION' PRINCIPLE ALSO APPLIES to unauthorized facsimiles of BALLY equipment, logos, designs, publications, assemblies and games (or game feature not deemed to be public domain), whether manufactured with BALLY components or not.

Notice

MIDWAY® is a registered trademark of Midway Manufacturing Company. INDIANAPOLIS 500™ and BALLY® are trademarks used by Midway with permission. WILLIAMS, Lane-change and Multi-ball are trademarks of WILLIAMS Electronics Games, Inc. Entire contents of this manual ©1995 MIDWAY MANUFACTURING COMPANY, manufacturers of BALLY Amusement Games. All rights reserved.

WARNING

NOTE: This equipment has been tested and found to comply with the limits for a Class A digital device, pursuant to Part 15 of the FCC Rules. These limits are designed to provide reasonable protection against harmful interference when the equipment is operated in a commercial environment. This equipment generated, uses, and can radiate radio frequency energy and if not installed and used in accordance with the instruction manual, may cause harmful interference to radio communications. Operation of this equipment in a residential area is likely to cause harmful interference in which case the user will be required to correct the interference at his own expense.

RF Interference Notice

CABLE HARNESS PLACEMENTS and ground strap routing on this game have been designed to keep RF radiation and conduction within levels accepted by the FCC Rules.

TO MAINTAIN THESE LEVELS, reposition harnesses and reconnect ground straps to their original placements, if they become disconnected during maintenance.

FCC STICKER. Check the back of your game to verify that an FCC-certification sticker was attached to your game at the factory. All Games that leave the BALLY plant have been tested and found to comply with FCC Rules. Because the sticker is proof of this fact, legal repercussions to the owner and distributor may result, if the sticker is missing. If you receive a game, manufactured after December 1982, that has no FCC sticker, call BALLY for advice or write us a note on your Game Registration Card. Be sure that the card bears your game's serial number.

FOR SERVICE...
CALL your authorized
BALLY Distributor

MIDWAY Manufacturing Company
3401 N. California Avenue
Chicago, IL 60618

"OFFICIALLY LICENSED PRODUCT"

©1995 Midway Manufacturing Company
ALL RIGHTS RESERVED

**CAUTION: Transport this game ONLY
with hinged backbox DOWN!**