

Instruction Manual for **LUCKY SEVEN SOLID STATE**

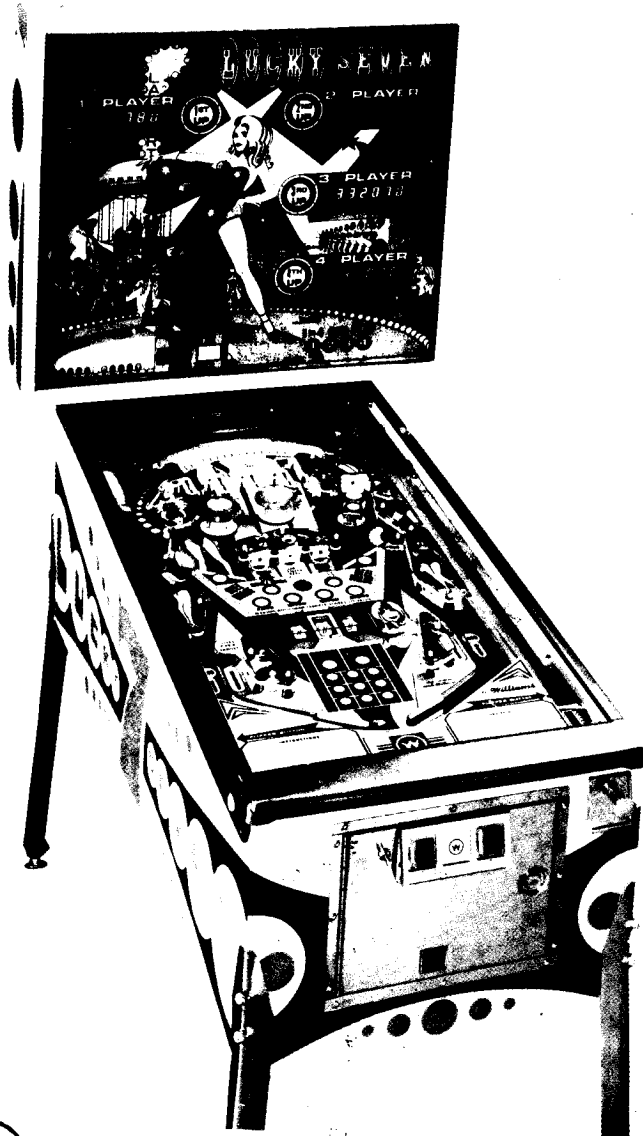

MARCH
1978



Williams[®] ELECTRONICS, INC.

SUBSIDIARY OF XCOR CORPORATION

3401 N. California Ave.
(312) 267-2240

Chicago, Ill. 60618, U.S.A.
Cable Address: Wilcoin

CONTENTS

Section:

1. Installation
 2. Game Operation
 3. Game Adjustments
 - a) Replay
 - b) Maximum Credits
 - c) Match / Credit / Extra Ball
 - d) High Score Credit
 - e) Play Adjustments
 - f) Maximum Tilts
 - g) Current Credits
 - h) High Score to Date
 - i) Game Pricing
 4. Game Bookkeeping
 5. Built in Diagnostics
 6. Troubleshooting Charts
 7. Interconnection Charts
 8. Mechanical Adjustments
 9. Spare Parts
- Schematics and Assembly Drawings

480 LUCKY SEVEN

INSERT

- 8. 1st PLAYER DISPLAY
- 9. 2nd PLAYER DISPLAY
- 10. 3rd PLAYER DISPLAY
- 11. 4th PLAYER DISPLAY
- 12. MASTER DISPLAY BOARD
- A. CREDIT DISPLAY
- B. BALL IN PLAY/MATCH

BACKBOX

- 1. CPU BOARD
- 2. DRIVER BOARD
- 3. POWER SUPPLY BOARD
- 4. KEY LOCK
- 5. RECTIFIERS
- 6. CAPACITOR
- 7. TRANSFORMER

CABINET (OUTSIDE)

- 13. CREDIT BUTTON
- 14. PLAYFIELD
- 15. LEG LEVELER
- 16. BALL SHOOTER

CABINET (INSIDE)

- 17. BALL ROLL TILT
- 18. PLUMB BOB TILT
- 19. KNOCKER ASSY.
- 20. 3" DRUM ASSY.
- 21. CHIMES ASSY.

FRONT DOOR

- 22. COIN REJECTOR
- 23. DIAGNOSTIC SWITCHES
- 24. COIN SLOTS
- 25. COIN RETURN

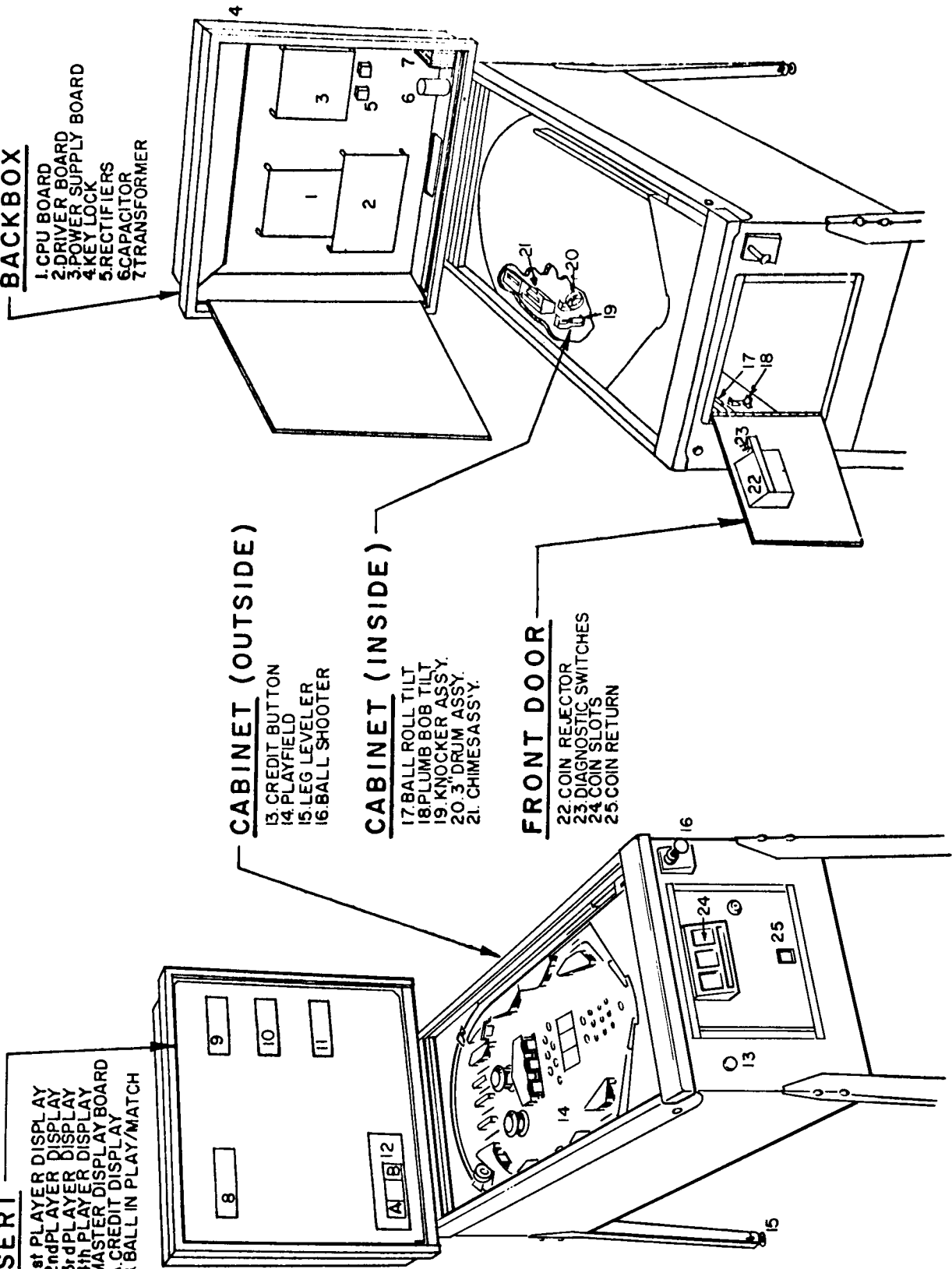

Figure 1

LUCKY SEVEN SECTION 1 INSTALLATION

The initial set up and assembly of the solid state LUCKY SEVEN is identical to mechanical pinballs.

First, remove the backbox and cabinet from their respective shipping cartons. Set up the cabinet and mount the legs. Reach into the large hole in the backbox and pull out the power cord and place it in the slot provided. Do not plug machine in at this time.

Next, remove the red shipping block from insert door and place the assembled backbox on the pedestal. Do not pull up any of the other cables from the cabinet at this time.

Note that the backbox has a metal bracket protruding from the square bottom hole. This bracket engages a similar bracket on the cabinet pedestal to prevent the backbox from tipping forward while the insert door is open.

Open the insert door by lifting the door latch (located at right) up. Install the backbox mounting bolts securely. Level the machine from side to side and front to back by adjusting the leg levelers.

There are six harnesses that must be interconnected next. Four of the harnesses are from the playfield and two are from the cabinet. The connectors are size and color coded and mate wires of the same color together, except in the case of the power line to the transformer connector, where the colors do not match. Connect the black plug to the black connector first. Then interconnect the remaining five connectors. **DO NOT** intermix the white connector and black plug even though they are the same size.

Next, connect the braided ground strap to the backbox shield liner by fastening it under the wing nut located just in front of the rectangular bottom hole in the backbox.

Then check the connectors to make sure that none of the wire terminations have come loose or were pushed out. Reseat any loose wires by pushing in on the wire terminations.

Also push on all the connectors that are attached to the CPU Board (Figure 1 - No. 1) to make sure they are firmly seated. Then push on all the connectors that are attached to the Driver Board (Figure 1 - No. 2) to make sure they are firmly seated. Also push on all the connectors that are attached to the Power Supply Board (Figure 1 - No. 3). Then check the connectors on both bridge rectifiers (Figure 1 - No. 5) and the filter capacitor (Figure 1 - No. 6).

Also check and push on all the connectors that are attached to the Master Display Board (Figure 1 - No. 12) and the connectors that leave the Master Display Board and go off to the four individual player displays (Figure 1 No. 8, 9, 10, 11). Finally, check and push on the connectors which interconnects the coin door mechanism to the cabinet harness.

After all the connectors have been checked as outlined above, gently press on the integrated circuit (IC) packages that are socketed on the CPU and Driver Boards. (See Figure 2). **DO NOT** remove any of the IC packages from their sockets. Also check that the batteries are still securely mounted to the CPU Board. **DO NOT REMOVE THE BATTERIES!** If the batteries are removed with power off the game will go to default values for all the options and particular changes will have to be restored manually before the game can be put on location. The batteries are all installed with the positive (+) end up. Battery life is about the same as shelf life or about one year. When it is time to replace the batteries, remove the batteries while the game is **ON** or the game will go to default values.

Check that all cables are clear of moving parts. Check for any wires that may have come disconnected. Check switches for loose solder or other foreign material that may have come loose in shipment. Check wires on coils for proper soldering. Check that fuses on the Power Supply Board are secure. Check adjustment of the four tilt switches: Playfield Shake on bottom of playfield, Super Slam on front door, Plumb bob tilt on left side of cabinet near front door and Ball Roll tilt above the Plumb bob. Refer to Section 8 for specific mechanical adjustments for each of these tilt switches.

Before plugging the machine in also check that the AC line fuse is secure in its holder. Install the ball in the roll tilt, if not already installed.

This machine **MUST BE PLUGGED INTO A PROPERLY GROUNDED OUTLET TO PREVENT SHOCK HAZARD** and to insure **PROPER GAME OPERATION**. **DO NOT** use a "cheater plug" to defeat the ground pin. **DO NOT** cut off the ground pin. The line voltage **MUST** agree with that on the shipping carton or serious damage to the machine will occur when it is plugged in.

The game is now ready to plug in and check out. Lower the playfield and close the insert door. Plug the game in and flip the power switch located near the right front cabinet leg on. The game will come on and should come up in the game over mode.

The game over mode is indicated by player scores reading zero, player one up light flashing, game over lights lit. The high score to date will alternate with player one score only. Flippers will be inoperative and the general illumination lamps will be lit. The game can now be checked out by play, or diagnostics can be run (See Section 5), or game option adjustments can be made (See Section 3).

If the game comes up in the diagnostic mode, the ball in play display will show 04 (Figure 1 - No. 12B) and the credit display will show 01 (Figure 1 - No. 12A). This indicates that either the batteries were removed or came loose during shipment. The game status has returned to factory default settings, and some values will probably have to be restored according to the procedure outlined in Section 3.

If the game does not light up or does not come up in game over or diagnostic mode, refer to troubleshooting Section 6.

LUCKY SEVEN

SOCKETED COMPONENTS

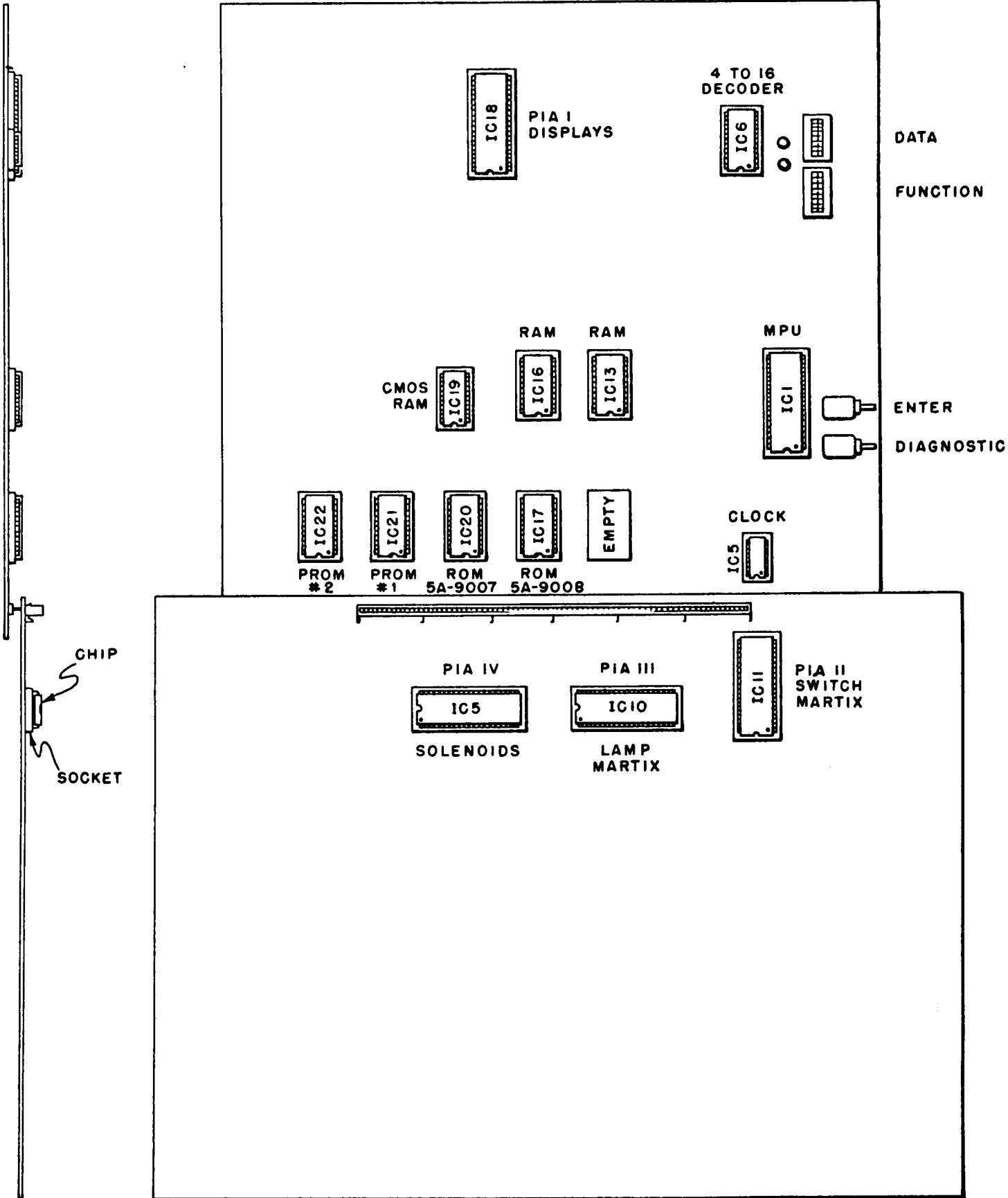

Figure 2

**SECTION 2
GENERAL GAME OPERATION AND SCORING**

Place ball into playfield by outhole. When machine is turned on it will come on in game over mode. Player 1 up light will be flashing. All player scores will be zero and Player 1 score will alternate from zero to High Score to Date.* Game over lights will be lit.

Insert coin into machine. The machine should accept coins and post credits. The knocker will sound for each credit. Pressing the credit button on the cabinet front will cause the outhole kicker to serve the ball, the credit display number will be reduced by one, the number of players light will show one, the tune will be played and the ball in play display will show 1. Pressing the credit button at any time before the ball in play displays 2 will allow additional players and change the players light and reduce the credits by one for each additional player.

Player one up light will flash and the reel value lights will sequence, if there is no valid combination on the reels, until the ball makes the first switch.

The bonus value is set to zero and the drop targets score 1000 points. The rollover switches score 1000 points, advance the bonus value, and change that reel. The advance bonus targets score 1000 points and advance the bonus value. The top left stand up switch scores 10 points and the bottom right stand up scores 50 points. The spinner score 10 points or 100 points when lit. The left and right kickers score 10 points. The inside left and right rollover switches score 1000 points and advance the bonus. The outside rollovers score 3000 points. The change left, center, right reel targets score 1000 points and cause that reel to rotate 1 position.

Certain combinations of reels cause a reel value lamp to light.* When **both** drop targets are knocked down, this value will be added to the player's score and the drop targets will be reset. If the lites double bonus, extra ball,* or special* lights are lit when both drop targets are down, the player will be awarded double bonus, extra ball,* or special*.

The default reel combinations are as follows:

| Left Reel | Center Reel | Right Reel | Scores |
|-----------|-------------|------------|-------------------------|
| Clover | Any | Any | 5,000 and Double Bonus |
| Clover | Clover | Any | 10,000 and Double Bonus |
| Clover | Clover | Clover | 20,000 and Extra Ball |
| Horseshoe | Horseshoe | Horseshoe | 20,000 |
| Diamond | Diamond | Diamond | 30,000 |
| Seven | Seven | Seven | 30,000 and Special |

Extra ball* won during the course of the game is played immediately after the player's regular ball enters the outhole. When the ball enters the outhole, the bonus score is added, the left and right reels are advanced one position and the ball is ejected. The player up light flashes to indicate the next player. The bonus score is reset to zero and all other scoring is set to normal.

After the last ball is played, the match digits* appear where the ball in play digits were. If a match occurs, an extra credit* will be awarded. The game over tune "Good Night Ladies" will play and the game over lights will light. The high score to date* will alternate with the winning player's score **only** and the winning player's player up light will flash.

If a player's score exceeds the current high score to date, three* credits will be awarded and the game will play "1812 Overture" and the high score light will remain lit.

A player has three* chances before the plumb bob tilt tilts the ball in play. The buzzer sounds to warn the player of the first two plumb bob tilts. The third tilts that player's ball. The ball roll and playfield shake tilt switches tilt the ball in play immediately. The super slam tilt on the coin door sets all players scores to zero and returns the game to game over.

If coins are inserted and the maximum* number of credits is exceeded, the credit will be posted correctly but the coin lockout coil will be de-energized until the remaining credits is below the maximum.

* These features are adjustable and the procedure is outlined in Section 4.

LUCKY SEVEN SOLID STATE - 480 PROMS - REV. "A"

| Test 4 Readout No. | Function Switch | Data Switch | Default Value | This Game |
|--------------------------|--------------------|--|------------------|---------------|
| 01 | 01 | Replay 1 (Chart 2) 10,000 pts | 200,000 (20) | _____ |
| 02 | 02 | Replay 2 (Chart 2) 10,000 pts | 300,000 (30) | _____ |
| 03 | 03 | Replay 3 (Chart 2) 10,000 pts | 400,000 (40) | _____ |
| 04 | 04 | Replay 4 (Chart 2) 10,000 pts | Disabled (*) | _____ |
| 05 | 05 | Maximum Credits (Chart 2) | 20 | _____ |
| 06 | 06 | Match/Credit/Extra Ball (Chart 1) | 00 | _____ |
| | | 00 - Match ON - Credit award at Replay Points | | _____ |
| | | 01 - Match ON - Extra ball award at Replay Points | | _____ |
| | | 04 - Match OFF - Credit award at Replay Points | | _____ |
| | | 05 - Match OFF - Extra ball award at Replay Points | | _____ |
| 07 | 07 | Not Used | 00 | _____ |
| 08 | 08 | High Score Credits (Chart 2) | 03** | _____ |
| 09 | 12 | Lowest coin slot multiplier (Chart 1) | 01 | _____ |
| 10 | 13 | Middle coin slot multiplier (Chart 1) | 01 | _____ |
| 11 | 14 | Highest coin slot multiplier (Chart 1) | 01 | _____ |
| 12 | 15 | Minimum coin units for credit (Chart 1) | 00 | _____ |
| 13 | 16 | Coin units bonus point (Chart 1) | 02 | _____ |
| 14 | 17 | Coin units per credit (Chart 1) | 01 | _____ |
| 15 | 18 | Play adjustments (Chart 2) | 03 | _____ |
| | | 03 - Normal play - 3 balls | | |
| | | 05 - Normal play - 5 balls | | |
| | | 13 - Liberal play - 3 balls | | |
| | | 15 - Liberal play - 5 balls | | |
| | | 23 - Extra ball for "special" - 3 balls | | |
| | | 25 - Extra ball for "special" - 5 balls | | |
| | | 43 - No Special, No Extra Ball - 3 balls | | |
| | | 45 - No Special, No Extra Ball - 5 balls | | |
| 16 | 19 | Maximum tilts (1-9) (Chart 2) | 03 | _____ |
| 17 | 20 | Current number of credits (Chart 2) | 00 | _____ |
| 18 | 21 | High score to date (Chart 2) 10,000 pts | 35 | _____ |
| | 22 | High score to date (Chart 2) 100 pts | 00 | _____ |
| | 23 | High score to date (Chart 2) 1 pts | 00 | _____ |
| 19 | — | Number of coins through Slot 1 | | Cannot be set |
| 20 | — | Number of coins through Slot 2 | | Cannot be set |
| 21 | — | Number of coins through Slot 3 | | Cannot be set |
| 22 | — | Number of credits payed for | | Cannot be set |
| 23 | — | Number of credits won | | Cannot be set |

* To disable a replay point turn **all** data switches ON for that replay function number.

** To disable high score credits turn **all** data switches OFF for function 08.

CHART 1

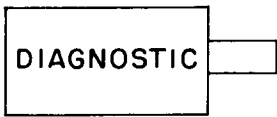
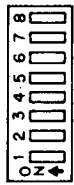
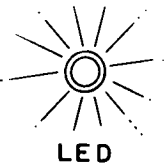
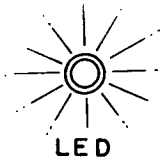

| | | | |
|----|----|----|----|
| 00 | 08 | 16 | 24 |
| 01 | 09 | 17 | 25 |
| 02 | 10 | 18 | 26 |
| 03 | 11 | 19 | 27 |
| 04 | 12 | 20 | 28 |
| 05 | 13 | 21 | 29 |
| 06 | 14 | 22 | 30 |
| 07 | 15 | 23 | 31 |

CHART 2

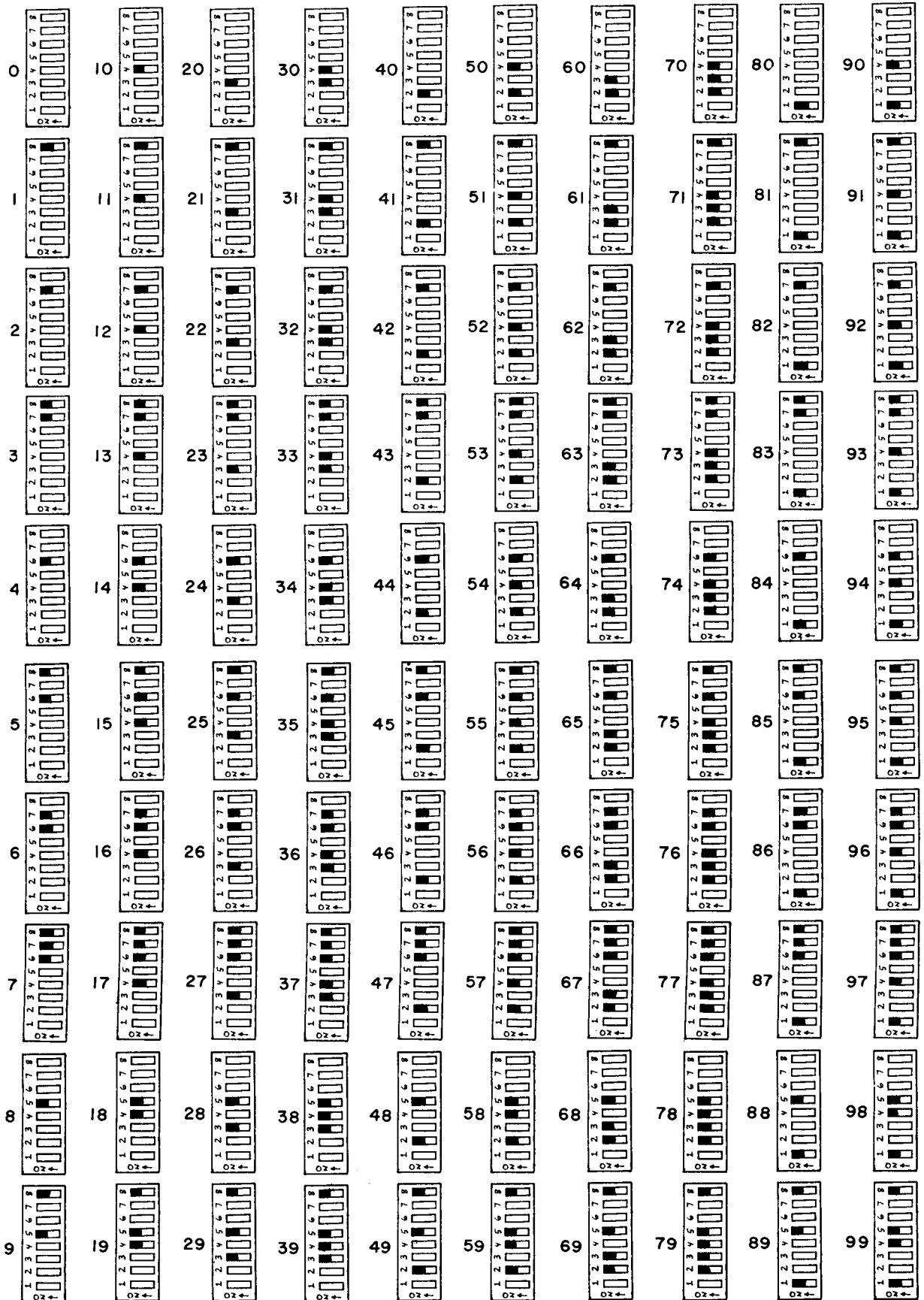

SECTION 3 GAME ADJUSTMENTS

The solid state LUCKY SEVEN offers great versatility in customizing the same to the location or operator's requirement. A very simple means of altering factory settings of various replay and other options has been devised. This section outlines the general procedure for making these changes.

Open the insert box door and locate the CPU Board (Figure 1 - No. 1). On the right hand side of the CPU Board there are two 8 position miniature slide switches and below them are two pushbuttons.

Prepare to enter the diagnostic mode by first turning off the machine and then turning it back ON. Then to enter diagnostics, press the lower pushbutton on the CPU Board. The two LED's to the left of the switches will blink twice and go off. If the LED's do not blink twice or stay on continuously, refer to troubleshooting guide in Section 6.

Determine which function is to be changed by looking at Table 1. To change the number of tilts per ball, for example, is function 19. The game is set up for 3 tilts per ball but can be changed to 1 tilt per ball very easily.

Next, since Function 19 is to be changed, set the BOTTOM switch identically to the switch beside the number 19 in Chart 1. A black mark on Chart 1 next to the switch number indicates that that position of the lower switch is ON (move switch to the left). No black mark indicates that that position switch number should be left OFF (move switch to the right).

The third step is to determine the new data to be entered. In this case Table 1 says to use Chart 2 and to enter a value from 1 to 9. The choice is 1 tilt per ball so the TOP switch must be set identically to the switch beside the number 01 in Chart 2. Data numbers may be specified as either Chart 2 or Chart 1 so care must be exercised to use the correct chart or erroneous data may be entered.

Once both the top switch and the bottom switch have been set correctly for the change desired, press the upper pushbutton of the two one time. The two LED's will blink to indicate that the change has been made. If the LED's do not blink when the ENTER pushbutton is depressed, recheck switch settings.

Continue to enter any other changes by checking Table 1 for the correct function number. Use Chart 1 and enter the function number on the lower switch. Then determine the new data desired, and refer to the specified chart for the function. Set the top switch accordingly. Then press the ENTER pushbutton (top pushbutton) once to lock in the new data. Continue to repeat this procedure for all changes.

The functions can be entered in any order. If a mistake is made in setting the data switches, the correct settings can be made and the ENTER button pressed again to enter the new data. Only the last data entered will be retained. If the batteries are removed with power OFF the data must be re-entered manually. There are two ways to verify the data changes entered. One is to turn the machine OFF and then ON again. Then play the machine to see if the new values are correct. A faster method is to use test 4 of the built in diagnostics, and this is described in Section 5 of this manual.

The following is a brief summary of all game adjustments.

Replay

There are four possible replays awarded from scoring. The default factory settings for the first replay occurs at 200,000 points; the second at 300,000, the third at 400,000 and the fourth is disabled. Replay 1 is function 01. It can be increased or decreased by any multiple of 10,000 points. Table 1 specified to use Chart 2 for setting the data switch. To establish a replay of 220,000 points instead of 200,000 points a value of $(22 \times 10,000 = 220,000)$ must be entered on the data switch, using Chart 2 to set up the top switch and Chart 1 to set up Function 01 in the function switch.

1. If not already in diagnostics, enter diagnostics by pressing the lower pushbutton once.
2. Set up function switch exactly like switch 01 in Chart 1.
3. Set up data switch exactly like switch 12 in Chart 2.
4. Press ENTER button once. The LED's will blink once once and the new data is locked in.

To disable the first replay point, turn **all** data switches ON (move switch to the left). Follow the procedure steps 1 thru 4, except that in step 3 remember to turn all switches ON.

To change or disable replays 2, 3, or 4, enter Function 02, 03, or 04 in step 2 and follow procedure steps 1 thru 4, substituting the new desired value in step 3.

Maximum Credits

Maximum credits is the number of credits that can be entered by putting coins in the machine before the coin lockout coil is released. The default value is 20 credits. Maximum credits is Function 05. It can be set for any value from 01 to 99 using Chart 2 as specified by Table 1. To establish a maximum credits of 10 for example, the function switch would have to be set as 05 and the data switch set to 10 using Chart 2.

1. If not already in diagnostics, enter diagnostics by pressing to lower pushbutton once.
2. Set up function switch exactly like switch 05 in Chart 1.
3. Set up data switch exactly like switch 10 in Chart 2.
4. Press ENTER button once. The LED's will blink once to indicate that the new data is locked in.

Match / Credit / Extra Ball

Credits given when a match occurs and extra balls or credits given at replay points can be disabled if desired. Default values give a replay credit for a match. The Credit/Extra Ball is Function 06 and Table 1 specifies to use Chart 1 for the data switch. There are four possible combinations of enabling these two features. Table 1 specifies that for Function 06 Chart 1 is to be used for the data switch values. Table 1 also shows the various possibilities and the value to enter on the data switch.

Data Switch

- 00 Match ON - Credit award at Replay points
- 01 Match ON - Extra ball award at Replay points
- 04 Match OFF - Credit award at Replay points
- 05 Match OFF - Extra ball award at Replay points

1. If not already in diagnostics, enter diagnostics by pressing the lower pushbutton once.
2. Set up function switch exactly like switch 06 in Chart 1.
3. Set up data switch like switch 00, 01, 04, or 05 in Chart 1.
4. Press ENTER button once. The LED's will blink to indicate that the new data is locked in.

High Score Credits

When the high score to date is exceeded by a player, any number of replay credits may be awarded. The default value is 3 credits. High score credits is Function 08 and Table 1 specifies to use Chart 2 for setting the date switch. In order to disable awarding high score credits, turn OFF all data switches to get a value of zero.

1. If not already in diagnostics, enter diagnostics by pressing the lower pushbutton once.
2. Set up function switch exactly like switch 08 in Chart 1.
3. Set up data switch according to Chart 2 for the number of credits to be awarded. To disable, turn OFF all data switches.
4. Press ENTER pushbutton once. The LED's will blink to indicate that the new data is locked in.

Play Adjustments

The number of balls per game can be set to 3 or 5 balls. The special can be made to award an extra ball instead of a credit or disabled altogether. Default values are 3 ball game, special and extra ball features allowed. There are eight possible combinations of play adjustments. Table 1 specifies that for Function 18 Chart 2 is to be used for the data switch values. Table 1 also shows the various possibilities and the value to enter on the data switch.

Data Switch

| | | |
|----|---------|---------------------------|
| 03 | 3 balls | Normal Play |
| 05 | 5 balls | Normal Play |
| 13 | 3 balls | Liberal Play |
| 15 | 5 balls | Liberal Play |
| 23 | 3 balls | Extra ball for "special" |
| 25 | 5 balls | Extra ball for "special" |
| 43 | 3 balls | No special, No extra ball |
| 45 | 5 balls | No special, No extra ball |

1. If not already in diagnostics, enter diagnostics by pressing the lower pushbutton once.
2. Set up the function switch exactly like switch 18 in Chart 1.
3. Set up the data switch for the number of balls and type of play desired using Chart 2.
4. Press ENTER pushbutton once. The LED's will blink to indicate that the new data is locked in.

High Score Credits

When the high score to date is exceeded by a player, any number of replay credits may be awarded. The default value is 3 credits. High score credits is Function 08 and Table 1 specifies to use Chart 2 for setting the date switch. In order to disable awarding high score credits, turn OFF all data switches to get a value of zero.

1. If not already in diagnostics, enter diagnostics by pressing the lower pushbutton once.
2. Set up function switch exactly like switch 08 in Chart 1.
3. Set up data switch according to Chart 2 for the number of credits to be awarded. To disable, turn OFF all data switches.
4. Press ENTER pushbutton once. The LED's will blink to indicate that the new data is locked in.

Number of Balls

The number of balls per game is set by default to 3 balls per game. Number of balls is function 18 and Table 1 specifies to use Chart 2. Enter either 03 or 05 on the data switch to get 3 or 5 ball play respectively.

1. If not already in diagnostics, enter diagnostics by pressing lower pushbutton once.
2. Set up function switch exactly like switch 18 in Chart 1.
3. Set up data switch according to Chart 2 for whatever value desired (01 to 09) (To disable enter a value of 01.)
4. Press ENTER pushbutton once. The LED's will blink to indicate that the new data is locked in.

Maximum Tilts (Plumb Bob Tilts Only)

The number of plumb bob tilts before forfeiting the ball can be set. Maximum tilt is function 19 and Table 1 says to use Chart 2 for the data switch values. The default value is normally set at 3. Shaking the machine causes the buzzer to sound. The third time the buzzer sounds results in forfeiture of that player's ball. All the other tilts do not have this multiple tilt capability; only the plumb bob tilt. To disable the multiple tilt feature, enter a value of 01.

1. If not already in diagnostics, enter diagnostics by pressing the lower pushbutton once.
2. Set up function switch exactly like switch 19 in Chart 1.
3. Set up data switch according to Chart 2 for whatever value desired (01 to disable).
4. Press ENTER pushbutton once. The LED's will blink to indicate that the new data is locked in.

Current Credits

The number of credits currently in the machine can be set to any number. Current credits is Function 20 and Table 1 specifies to use Chart 2 for the value to be entered on the data switch. Any number of free credits can be entered in this manner.

1. If not already in diagnostics, enter diagnostics by pressing lower pushbutton once.
2. Set up function switch exactly like switch 20 in Chart 1.
3. Set up data switch according to Chart 2 for whatever value desired (01 to disable).
4. Press ENTER pushbutton once. The LED's will blink to indicate that the new data is locked in.

High Score To Date

The high score to date default value for LUCKY SEVEN is 350,000 points. Functions 21, 22, and 23 allow setting the score to any value desired: Function 21 sets up the value of the 100,000 and 10,000 pts digits. Function 22 sets up the value of the 1000 and 100 pts digits. Function 23 sets up the value of the 10 and 1 pts digits. For example, to make the high score to date 435,750 points, Function 21 would have to have its data switch set up for a value of 43. Then Function 22 would have to be set up and its data switch would have to be set for a value of 57. Finally, Function 23 would have to be set up and its data switch value entered as 50. This would result in 43, 57, and 50 being set as the high score to date - 435,750. Any value can be entered in this manner.

1. If not already in diagnostics, enter diagnostics by pressing lower pushbutton once.
2. Set up the function switch exactly like switch 21, 22, or 23 in Chart 1.
3. Set up the data switch for the new value using Chart 2.
4. Press ENTER pushbutton once. The LED's will blink to indicate that the new data is locked in.

Repeat steps 2 thru 4 to change any other of the digit pairs, using the appropriate function number in step 2.

Game Pricing

Six different functions control the various options in setting game pricing. Three pertain to the particular coin door mechanism installed on the game and three pertain to minimum number of coins and the credits awarded for the coins inserted.

The solid state LUCKY SEVEN has been designed with versatility in mind. Different coin door mechanisms can be interchanged without extensive rewiring simply by plugging the new coin door mechanism in and changing the six functions.

There are many combinations of coin values and three chute or twin chute coin mechanisms. This explanation will detail how the six functions interrelate and describe sample settings and pricing.

The first step in setting game pricing is to establish the number of coin chutes and the relative value of the coins. Function 12 will pertain to the lowest value coin chute, normally the left chute. Function 13 pertains to the middle value coin chute, normally the center chute. Function 14 pertains to the highest value coin chute, normally the right chute. In the case of a twin chute mechanism, Function 13 would be set to a value of zero.

Next, determine the lowest value single coin, the middle value single coin, and the highest value single coin that can be put into the machine. For example, in a 5, 10, and 25¢ machine the lowest value coin is 5¢, the middle 10¢, and highest coin is 25¢. In a twin quarter chute the lowest and highest value is 25¢ and there is no middle value coin.

Then, reduce all the coin values by dividing each of them by the largest number possible that leaves a remainder of zero. First, try dividing each coin value by 2. If there are any remainders other than zero, try dividing by 3. If there are remainders other than zero, try dividing by 4 etc. until the value of the smallest value coin is reached as the divider.

For example, in a 5, 10, and 25 cent mechanism, $25 \div 5 = 5$ remainder zero and $10 \div 5 = 2$ remainder zero. In a 25 cent twin chute mechanism, $25 \div 25 = 1$ remainder zero. In a 10, 10, and 25 cent mechanism, the largest divider is 5, leaving values of 2, 2, and 5.

These values become the coin slot multipliers and are entered into the machine using Functions 12, 13, and 14. In the examples given above, the 5, 10, and 25 cent machine would have function 12 set to 01, function 13 set to 02, and function 14 set to 05. For the twin quarter chute, function 12 would be set to 01, function 13 set to 00 because there is no center chute, and function 14 set to 01. For 10, 10, 25 mechanisms, function 12 would be set to 02, function 13 set to 02, and function 14 set to 05.

The relative value of all the coins for the coin mechanism has now been established. Next, determine if there is a minimum amount to be entered before giving any credits. For example, the machine can be set to give 3 credits for 50 cents, but no credits until at least 50 cents has been entered. If there is no minimum required, set Function 15 to a value 00. If there is a minimum, divide it by the same divider used to reduce the coin values. For example, in the 5, 10, 25 machine, the divider is 5. If a minimum of 50 cents has to be entered before giving any credits, divide 50 by 5 to get an answer of 10. This will be the value entered on the data switch for function 15. In the twin quarter chute, the divider was 25. When 25 is divided into 50 cents minimum, the answer is 2 so 02 would be the value entered for function 15. For the 10, 10, 25 mechanism, the divider was 5. When 5 is divided into 50 cent minimum, the answer is 10 so the value 10 is entered for Function 15. Any minimum can be established in this manner, so long as the divider used to reduce the coin values goes into the minimum with a remainder of zero. A minimum of 65 cents could not be entered for a 25 cent machine, but could be entered for a 5, 10, 25 cent machine if desired.

The next function to be determined is the number of credits to be given for coins. Again, the values entered in Functions 12, 13, and 14 are used as a guideline. Each coin dropped through the coin chute will award the number of units as set by Functions 12, 13, and 14. If, for example, one credit is to be given for each 25 cents deposited in a 5, 10, 25 machine, the number 05 would be entered as data for function 17. Depositing 5¢ gives 1 unit 10¢ 2 units, and 25¢, 5 units. Any combination of nickels and dimes would award 1 credit, as would 25 cent pieces. If one credit is to be given for each 50 cents worth of coins deposited in a 5, 10, 25 machine, a value of 10 would be entered as data for function 17.

For the twin chute 25 cent machines, if 2 quarters were required to award 1 credit, a 02 would be entered for data for function 17. If 25 cents awarded 1 credit, a 01 would be entered for data for function 17. To easily determine the data, use the value entered for the lowest coin value and determine how many lowest value coins must be deposited to award a single credit. Use this number for function 17. (Sample settings are given at the end of this section)

The last function that needs to be determined is the number of bonus credits given for coins (if any). Bonus credits is Function 16 and can be disabled by entering a value of 00.

To determine the bonus credit value, use the value entered for Function 17 as follows: To award a bonus credit for every 2 credit worth of coins, enter double the value of function 17 as the data in function 16. For example, twin quarter chutes: 1 play 25 cents, 3 plays 50 cents. Function 17 would be a 01, so set Function 16 as twice 01, or 02. To award a bonus credit for every 3 credits worth of coins, enter triple the value of function 17 as the data for function 16. For the example cited above, 03 would be entered so that for every 75 cents an extra credit would be given.

Sample Settings

| Price | 5, 10, 25 Coin Door | | | | | | 25, 0, 25 Coin Door | | | | | |
|--------------------------------|---------------------|----|----|----|----|----|---------------------|----|----|----|----|----|
| | Function | | | | | | Function | | | | | |
| | 12 | 13 | 14 | 15 | 17 | 16 | 12 | 13 | 14 | 15 | 17 | 16 |
| 1 Play 25¢ | 01 | 02 | 05 | 00 | 05 | 00 | 01 | 00 | 01 | 00 | 01 | 00 |
| 1 Play 25¢ 3 Play 50¢ | 01 | 02 | 05 | 00 | 05 | 10 | 01 | 00 | 01 | 00 | 01 | 02 |
| 2 Play 25¢ | 02 | 04 | 10 | 10 | 05 | 00 | 02 | 00 | 02 | 00 | 01 | 00 |
| 2 Play 25¢ 5 Play 50¢ | 02 | 04 | 10 | 10 | 05 | 20 | 02 | 00 | 02 | 02 | 01 | 04 |
| 3 Play 25¢ | 03 | 06 | 15 | 15 | 05 | 00 | 03 | 00 | 03 | 00 | 01 | 00 |
| 3 Play 25¢ 7 Play 50¢ | 03 | 06 | 15 | 15 | 05 | 30 | 03 | 00 | 03 | 00 | 01 | 06 |
| 4 Play 25¢ | 04 | 08 | 20 | 20 | 05 | 00 | 04 | 00 | 04 | 00 | 01 | 00 |
| 5 Play 25¢ | 05 | 10 | 25 | 25 | 05 | 00 | 05 | 00 | 05 | 05 | 01 | 00 |
| 1 Play 25¢ 3 Play 50¢ | 01 | 02 | 05 | 00 | 05 | 10 | 01 | 00 | 01 | 00 | 01 | 02 |
| 1 Play 50¢ | 01 | 02 | 05 | 00 | 10 | 00 | 01 | 00 | 01 | 00 | 02 | 00 |
| 1 Play 50¢ 3 Play \$1.00 | 01 | 02 | 05 | 00 | 10 | 20 | 01 | 00 | 01 | 00 | 02 | 04 |
| 1 Play 75¢ | 01 | 02 | 05 | 00 | 15 | 00 | 01 | 00 | 01 | 00 | 03 | 00 |
| 1 Play 75¢ 3 Play \$1.50 | 01 | 02 | 05 | 00 | 15 | 30 | 01 | 00 | 01 | 00 | 03 | 06 |
| 1 Play \$1.00 | 01 | 02 | 05 | 00 | 20 | 00 | 01 | 00 | 01 | 00 | 04 | 00 |
| 1 Play \$1.00 3 Play \$2.00 | 01 | 02 | 05 | 00 | 20 | 40 | 01 | 00 | 01 | 00 | 04 | 08 |
| 2 Play \$1.00 | 01 | 02 | 05 | 20 | 10 | 00 | 01 | 00 | 01 | 04 | 02 | 00 |
| 3 Play \$1.00 | 01 | 02 | 05 | 20 | 06 | 00 | 03 | 00 | 03 | 12 | 04 | 00 |

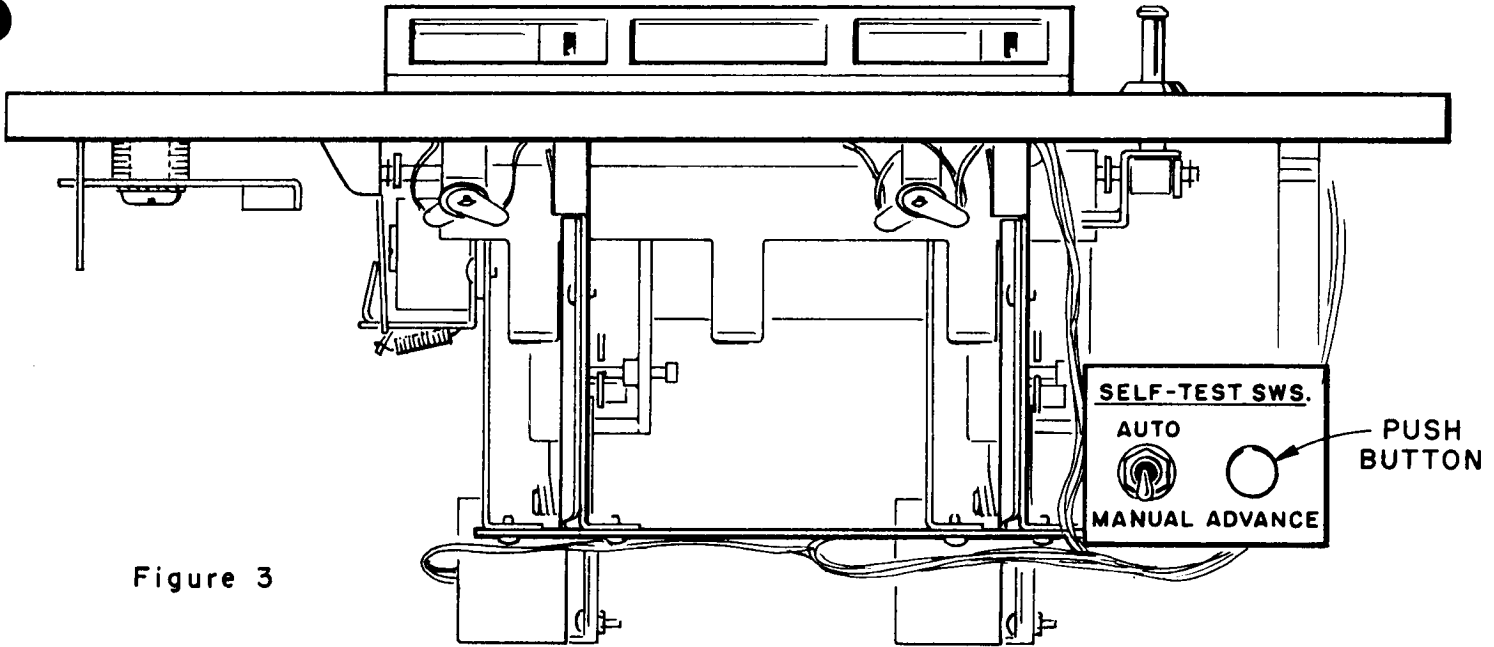

Figure 3

SECTION 4 GAME BOOKKEEPING

The game is designed with operator in mind. There are 5 separate game bookkeeping totals which can be accessed from the coin door. (See Figure 3).

With the game in the game over mode, place the coin door diagnostic switch in the manual position. Then press the advance switch once. This immediately enters the diagnostic at test 4, subtest 18. This displays the current high score to date in the Player 1 display. Press the advance switch again and this advances the diagnostic to test 4, subtest 19. This displays the number of coins through Slot 1. Press the advance switch again to go to subtest 20, which displays the number of coins through Slot 2. Press the advance switch again to go to subtest 21, which displays the number of coins through Slot 3.

There are two additional bookkeeping entries which are again accessed by pressing the advance switch. Test 4, subtest 22 displays the number of credits paid for. Pressing the advance switch again advances to subtest 23, which displays the number of credits won.

To return to game over after reading out the bookkeeping totals, place the AUTO/MANUAL switch to AUTO and press ADVANCE once. This will return the game to game over.

| | | |
|-----------------|----|--------------------------|
| Test 04 Subtest | 18 | High Score to Date |
| | 19 | Number of Coins - Slot 1 |
| | 20 | Number of Coins - Slot 2 |
| | 21 | Number of Coins - Slot 3 |
| | 22 | Number of Credits paid |
| | 23 | Number of Credits won |

The bookkeeping totals are not resettable to zero, therefore a log similar to Figure 4 is recommended. If there is no coin slot #2, the number displayed is of no significance and should be ignored.

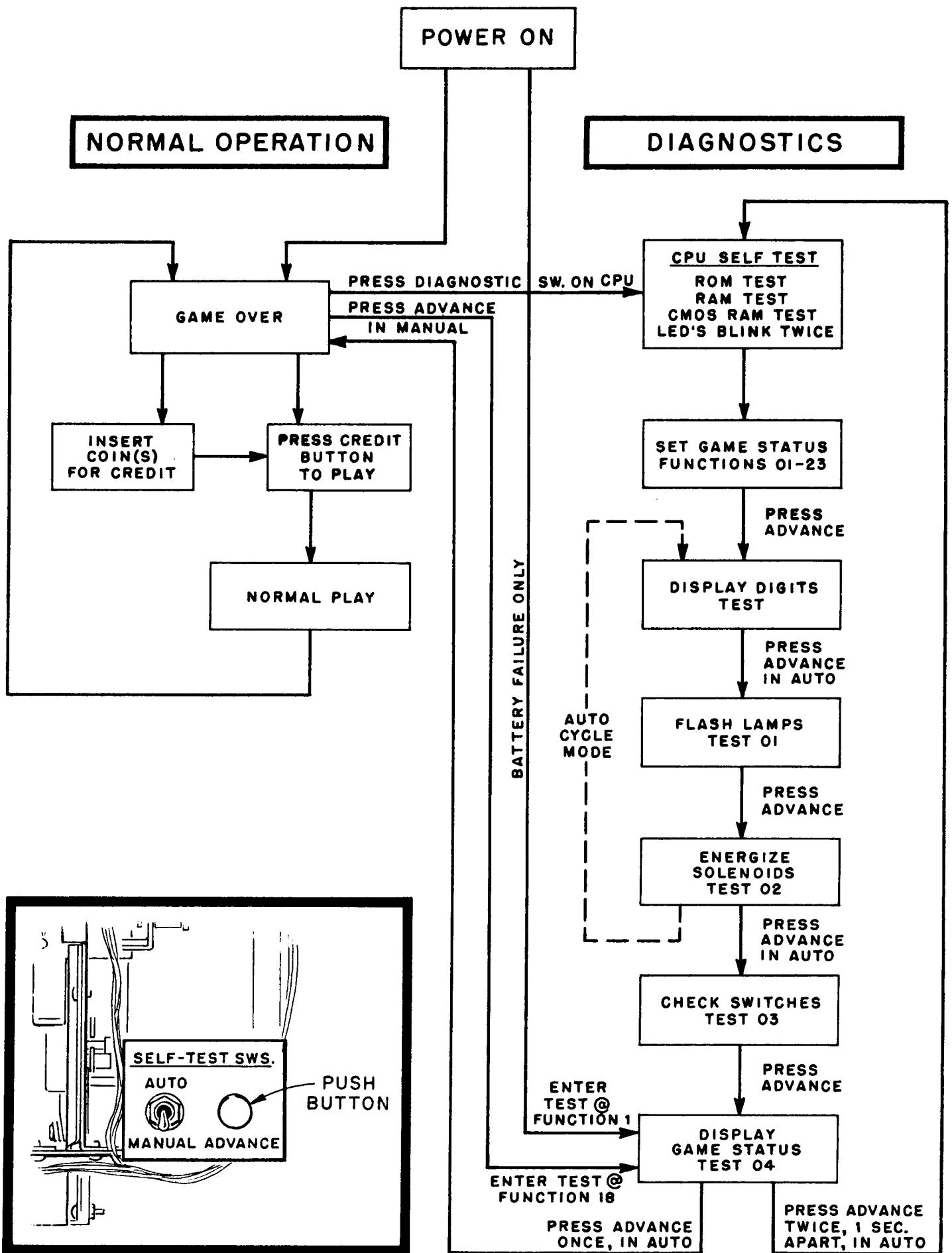

Figure 5

SECTION 5 BUILT IN DIAGNOSTICS

The built in diagnostics were designed for ease of operation and thoroughness. The diagnostics have been organized in such a way as to allow individual testing of different areas in the machine. These areas include:

- a) CPU Board Self - Test
- b) Game Status change
- c) Display digits test*
- d) Lamps (test 01)
- e) Solenoids (test 02)*
- f) Switches (test 03)*
- g) Game status display (test 04)*

* There are specific subtests in these tests. The different ways to enter the diagnostics and normal game operation are shown in Figure 5. There is also an auto cycle test which will be discussed later.

DIAGNOSTIC SWITCHES

There are three switches which are used to control the operation of the diagnostics:

1. Diagnostic switch (lower pushbutton on CPU)
2. Auto/Manual (inside coin door)
3. Advance switch (inside coin door)



Pressing the Diagnostic switch on the CPU Board initiates the diagnostics and causes the CPU to perform three self tests automatically:

1. ROM/PROM test
2. RAM test
3. CMOS RAM test

If any errors are detected, the two LED's on the CPU Board will light to indicate the specific failure. If all three tests pass successfully, the two LED's will blink twice and then go off. The diagnostics will then be in GAME STATUS CHANGE.

CPU BOARD SELF TESTS ROM/PROM TEST

The ROM/PROM test specifically checks the contents of CPU Board IC 17, IC 20, IC 21, IC 22 to see if the information in the ROM's and the field PROMS is correct. If the information is incorrect, the bottom LED will light up and the top LED will be OFF on the CPU Board.

OFF  ROM/PROM failure
ON 



RAM TEST

The RAM test specifically checks the ability of the RAM IC's 13 and IC 16 to retain information correctly. If the information is not retained correctly, the CPU Board top LED will light up and the bottom LED will be OFF.

ON  RAM failure
OFF 

CMOS RAM TEST

The CMOS RAM test specifically checks the ability of the CMOS RAM IC 19 to retain information correctly. If the information is not retained correctly, both LED's will light up and stay ON on the CPU Board.

ON  CMOS RAM failure
ON 

GAME STATUS CHANGE

Following the successful completion of the CPU Board self tests, the two LED's blink twice and the diagnostic program enters the game status change area. This is the only time that changes can be entered as outlined in Section 3 of this manual. Replay points, maximum credits, match features, etc. can be changed ONLY during this portion of the diagnostics. Any changes made to the data will not be displayed until the game status display (test 04) described later. After making all game status changes (if any), press the ADVANCE pushbutton once to go to the digits test.

NOTE: This section of the diagnostic is the only section where ALL player and master display digits are turned OFF. No digits show on the displays until the next section of the diagnostics is entered by pressing the ADVANCE pushbutton on the coin door.

DISPLAY DIGITS TEST

This test is controlled by the two switches mounted on the coin door. If the AUTO/MANUAL switch is in the AUTO position, the digits on the display will alternate from 0 to 1 etc to 9 and back to 0, 1, etc. This will continue until the ADVANCE pushbutton is pressed.

If the AUTO/MANUAL switch is in the MANUAL position when entering the test, the digit displays will show all zeros and will remain at zero until the ADVANCE is pressed. This will change all the displays to all 1's. Pressing ADVANCE again will change the display to all 2's etc.

Chart 3
LUCKY SEVEN Solenoid List

Each time the ADVANCE pushbutton is pressed the digits will change. Returning the AUTO/MANUAL switch to the AUTO position will cause the digits to start cycling automatically. To regain manual control, place the AUTO/MANUAL switch to the MANUAL position and press the ADVANCE pushbutton. To exit this test and proceed to the LAMP Test (Test 01), place the AUTO/MANUAL switch to the AUTO position and press the ADVANCE pushbutton once. All the displays will clear. The match digits will display 01 to indicate test 01 and the diagnostic will go to the lamp test.

LAMP TEST - TEST 01

This test causes all multiplexed lamps to blink on and off. The AUTO/MANUAL switch has no effect in this test. All lamps will continue to blink until the ADVANCE pushbutton is pressed. This causes the diagnostic to proceed directly to the Solenoid Test (Test 02). Note that the general illumination lamps do not blink on and off during this or at any other time.

SOLENOID TEST - TEST 02

When this test is entered the match digits will display 02 to indicate test 02. This test is controlled by the AUTO/MANUAL switch and the ADVANCE pushbutton.

This test is designed to pulse each solenoid for 15 milliseconds. The credit display will indicate the number of the solenoid being pulsed. Refer to Chart 3 for the solenoid identification list. Note that the solenoids numbered 07, 08, 21, 22 are not used. Also note that 15 milliseconds is too short a pulse duration to actuate the coin lockout coil and it is insufficient to raise lowered drop targets.

If the AUTO/MANUAL switch is in the AUTO position when this test is entered, the test will automatically sequence from solenoid 01 to 02 to 03 etc. to 22 and back to 01, 02, 03 etc. This will continue until either the ADVANCE pushbutton is pressed to go on to the next test or the AUTO/MANUAL switch placed to the MANUAL position and the ADVANCE pushbutton pressed, causing the test to cycle only the solenoid where the pause occurred.

If the AUTO/MANUAL switch is in the MANUAL position when this test is entered, the test will operate solenoid 01 repeatedly until the ADVANCE pushbutton is pressed. Then the solenoid 02 will be operated repeatedly until the ADVANCE pushbutton is again pressed. Placing the AUTO/MANUAL switch to the AUTO position at any time will cause automatic sequencing to resume. When the ADVANCE pushbutton is pressed with the AUTO/MANUAL switch in the AUTO position, the diagnostics will advance to the SWITCH TEST.

- | | | |
|----|-----------------------------------|-----------------------------|
| 01 | Left Reel | |
| 02 | Center Reel | |
| 03 | Right Reel | |
| 04 | Left Drop Target Reset | |
| 05 | Right Drop Target Reset | |
| 06 | Ball Release | |
| 07 | Not Used | |
| 08 | Not Used | |
| 09 | 10 Point Chime (Large) | |
| 10 | 100 Point Chime (Medium - Large) | |
| 11 | 1000 Point Chime (Medium - Small) | |
| 12 | 10,000 Point Chime (Small) | |
| 13 | Noise Drum | |
| 14 | Credit Knocker | |
| 15 | Buzzer | |
| 16 | Coin Lockout* | * NOTE: 15 msec is not long |
| 17 | Left Jet Bumper | enough to energize |
| 18 | Right Jet Bumper | this coil. |
| 19 | Right Kicker | |
| 20 | Left Kicker | |
| 21 | Not Used | |
| 22 | Not Used | |

SWITCH TEST - TEST 03

When this test is entered the match digits will display 03 to indicate test 03. The position of the AUTO/MANUAL switch has no effect on the operation of this test.

After entering this test, the credit display will display up to four switches on the playfield that are closed or stuck. After this listing is complete only the last switch closed will be indicated. If NO switches are closed when this test is entered the credit display will be blank.

All switches can be checked by closing the switch manually and observing that the switch number appears in the credit display. To exit this section of the diagnostics, press the ADVANCE pushbutton to go to the display game status test 04.

Refer to Chart 4 for the description and location of all switches in the LUCKY SEVEN playfield. Note that switches 01 thru 08 are not on the playfield itself and that switch 17 is closed only as a result of both left and right drop targets down. Note also that switches #41 and 50 are not displayed in this test.

DISPLAY GAME STATUS - TEST 04

When this test is entered, the match digits will display 04 to indicate test 04. This test displays on Player 1 display the current game status for the 18 functions that can be changed according to section 3 in this manual and for the 5 bookkeeping totals which can be accessed as described in Section 4. Changes to the game status CANNOT be made at this time! To make changes the diagnostics must be in the Game Status Change section of the diagnostics as previously explained.

LUCKY SEVEN

PLAYFIELD SWITCHES

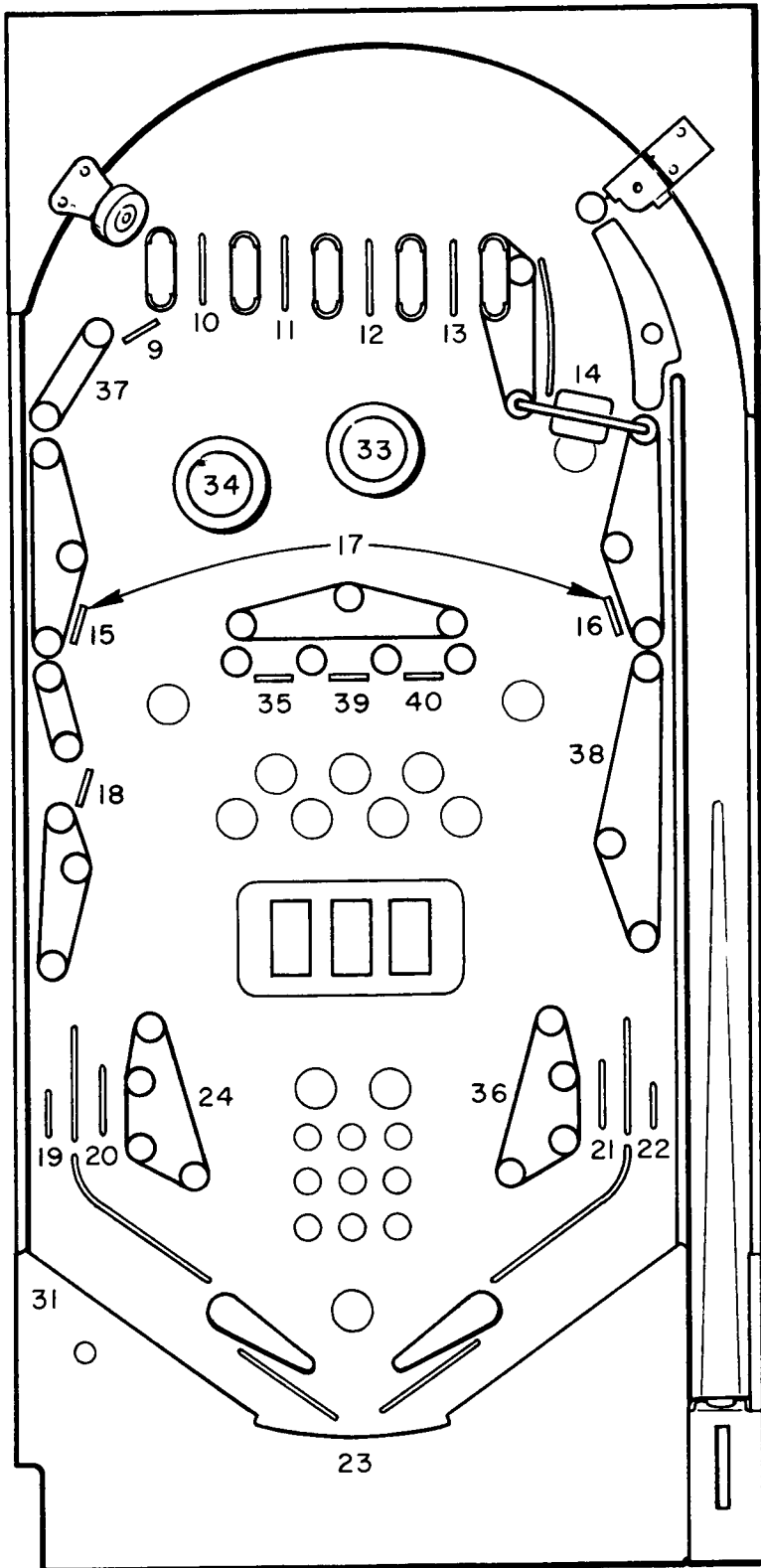

"LUCKY SEVEN" SWITCH LIST

- | | | |
|--------|-----------------------------|---------------------------|
| 01 | Plumb Bob Tilt | } IN BOTTOM CABINET |
| 02 | Ball Roll Tilt | |
| 03 | Credit Button | |
| 04 | Right Coin Switch | |
| 05 | Center Coin Switch | |
| 06 | Left Coin Switch | |
| 07 | Slam Tilt | |
| 08 | Not Used | |
| 09 | Top Advance Bonus Target | |
| 10 | Advance Bonus Rollover | |
| 11 | Left Reel Rollover | |
| 12 | Center Reel Rollover | |
| 13 | Right Reel Rollover | |
| 14 | Spinner | |
| 15 | Left Drop Target | |
| 16 | Right Drop Target | |
| 17 | Both Drop Targets Down | |
| 18 | Bottom Advance Bonus Target | |
| 19 | Left Outside Rollover | |
| 20 | Left Inside Rollover | |
| 21 | Right Inside Rollover | |
| 22 | Right Outside Rollover | |
| 23 | Outhole | |
| 24 | Left Kicker | |
| 25, 26 | Not Used | |
| 27 | Left Clover | |
| 28 | Three Sevens | |
| 29 | Three Horseshoes | |
| 30 | Three Diamonds | |
| 31 | Playfield Tilt | |
| 32 | Not Used | |
| 33 | Right Jet Bumper | |
| 34 | Left Jet Bumper | |
| 35 | Left Reel Target | |
| 36 | Right Kicker | |
| 37 | Top Left Stand Up | |
| 38 | Bottom Right Stand Up | |
| 39 | Center Reel Target | |
| 40 | Right Reel Target | |

CHART 4

When this test is entered, if the AUTO/MANUAL switch is in the AUTO position the test will sequentially display the game status data values on the Player 1 display and the function number on the credits display and continue cycling until the ADVANCE pushbutton is pressed. If the ADVANCE pushbutton is pressed once, the diagnostics will end and the game will go to the GAME OVER mode. If the ADVANCE pushbutton is pressed once and then after a 1 second pause pressed a second time, the diagnostics will start all over again with the CPU Self Tests and then go to Game Status Change section of the diagnostics.

If the AUTO/MANUAL switch is in the MANUAL position when the test is entered, the credit display will show 01, Player 1 display the value of whatever is function 01, and will remain that way until the ADVANCE pushbutton is pressed, at which time the value for function 02 will be display on Player 1 display and 02 will display in the credit display. Each time the ADVANCE pushbutton is pressed, the credit display will increment by 1 until 23 is reached then it will return to 01. This will continue until the AUTO/MANUAL switch is returned to the AUTO position and the ADVANCE pushbutton pressed once or twice as described above. Note that for test 4 function numbers 8 thru 14, values above 09 will not be displayed correctly. Refer to Table 1 for an explanation of the values read our during this test.

AUTO CYCLE MODE

As an aid in diagnosing intermittent problems or as a means to let the machine cycle itself through portions of the diagnostics, provision was made for the AUTO CYCLE MODE. This mode will sequence through the digit display test, go to test 01 and flash the lamps 128 times then go to test 02 and energize each solenoid then digit test, test 01, etc. This can be allowed to run indefinitely or until the ADVANCE pushbutton is pressed to regain control of the diagnostics.

To enter the AUTO CYCLE MODE:

1. Turn game OFF then turn game ON.
2. Press the diagnostic pushbutton on the CPU Board to enter diagnostics.
3. Set the data and function switches as follows:
DATA SWITCH (TOP SWITCH) - Turn **all** switches OFF. FUNCTION SWITCH (BOTTOM SWITCH) - Turn **all** switches OFF then turn ON only switch 1.
4. Press ENTER pushbutton on CPU Board. The two LED's will blink to accept the data.
5. Place the AUTO/MANUAL switch to AUTO.
6. Press ADVANCE pushbutton ONCE. The AUTO CYCLE MODE will begin and continue until the ADVANCE pushbutton is pushed again to regain manual control of the diagnostics or the machine is turned OFF.

**SECTION 6
TROUBLESHOOTING CHARTS**

This section, along with the diagnostics, allows the operator to locate any problems to the specific area responsible for the problem.

If game exhibits a specific problem with

- Lamp - See Section 6A
- Switch - See Section 6B
- Solenoid - See Section 6C
- Master Display - See Section 6D
- Player Display - See Section 6E
- Game Operation - See Section 6F

If the game does not play at all or blows fuses - see Section 6G

If the game plays intermittently - See Section 6H

If the game comes on in diagnostic test 04, subtest 01 - See Section 6I

Section 6A - Place Diagnostics in Test 01

LAMP TROUBLESHOOTING CHART

1 LAMP

Always OFF

1. Check Bulb
2. Check Diode (Observe Polarity)
3. Check wiring (broken wires)

Glow DIM

1. Check Bulb (correct # bulb)
2. Check Diode (Observe Polarity)
3. Check wiring (shorted wires)

Always ON

1. Check Diode (Observe Polarity)
2. Check wiring (shorted wires)

4-8 LAMPS

Always OFF

1. Check wiring (broken wires)
2. Check Connectors (2J5, 2J7)
3. Replace Driver Board

Glow DIM

1. Check wiring (broken wires)
2. Check Diodes
3. Check Connectors (2J5, 2J7)
4. Replace Driver Board

Always ON

1. Check wiring (shorted wires)
2. Check Diodes
3. Check Connectors (2J5, 2J7)
4. Replace Driver Board

ALL LAMPS

Always OFF

1. Check fuse 3F3 on Power Supply
2. Check for + 18 VDC on fuse 3F3 to ground
3. Check Connector 3J4
4. Check Connector 8P2/8J2
5. Check wiring (Broken or shorts)
6. Replace Driver Board

Glow DIM

1. Check line voltage
2. Check for + 18VDC on fuse 3F3 to ground

GENERAL ILLUMI.

Always ON

Normal Condition

Always OFF

1. Check Fuse 3F4 on Power Supply
2. Check for + 6.3 VAC
3. Check Connectors (3J3)
4. Check Connectors 9P1 and 8P2/8J2
5. Check wiring (broken or short)

Glow DIM

1. Check line voltage

All lamps are N44 or equivalent
All diodes are IN4001 or equivalent

Section 6B - Place Diagnostics in Test 03

SWITCH TROUBLESHOOTING CHART

1 SWITCH

Always Actuated

1. Check contacts
2. Check shorted wires

Never Actuates

1. Check adjustment
2. Check broken wires
3. Check for open diode by jumpering across diode and actuating.

4-8 SWITCHES

Always Actuated

1. Check adjustments
2. Check shorted wires on playfield or to 2J2, 2J3
3. Replace Driver Board

Never Actuated

1. Check adjustment
2. Check broken wires on playfield or 2J2, 2J3
3. Check plug 8P1/8J1 for broken wires or pushed out pins
4. Replace Driver Board

Switch Closure Displays Multiple Switch Numbers

1. Check adjustments
2. Check shorted wires on playfield or to 2J2, 2J3
3. Replace Driver Board

Switch Displays Incorrect No.

1. Check correct switch chart for game and check adjustment
2. Incorrect wiring on playfield 2J2, 2J3, or 8P1/8J1
3. Check Connector keying

ALL SWITCHES

1. Check adjustments
2. Check Connectors 2J2, 2J3, are not exchanged
3. Replace Driver Board

Section 6C - Place Diagnostics in Test 02

SOLENOID TROUBLESHOOTING CHART

1 SOLENOID

Never Actuates

1. Check solenoid Chart to verify number correct and in use
2. Broken wire to solenoid
3. Shorted diode across solenoid
4. Shorted/burned out solenoid
5. Open driver for that solenoid - replace Driver Board

Always Actuated

1. Shorted wire for that solenoid
2. Shorted driver for that solenoid on Driver Board - replace Driver Board

ALL SOLENOIDS

Never Actuated

1. Check for + 28VDC on Power Supply fuse 3F2 to ground
2. Check fuse 3F2 on Power Supply
3. Check Connectors 3J3 and 3J4 on Power Supply
4. Check Connector 2J9, 2J10, 2J11, 2J12 for broken/shorted wires.
5. Replace Driver Board

FLIPPERS

FLIPPER INOPERATIVE

1. Switch contacts on flipper button open or out of adjustment
2. Check Connectors from switch to back box to driver board
3. Shorted diode across coil

FLIPPER WEAK

1. Switch contacts on flipper button out of adjustment or pitted contacts.
2. End of stroke switch on solenoid not adjusted properly
3. Check connections on solenoid and check for bind

Section 6D - Place Diagnostics in Display Digits Test

Master Display Troubleshooting Chart

NO DISPLAY

1. Check - 300VDC, - 100VDC, + 100VDC & fuse 3F1 on Power Supply
2. Check connectors 3J5, 4J7, 4J5, 1J3, 1J5, 1J6, 1J7
3. Check for + 100VDC and - 100VDC on connector 4J7 - replace Power Supply Board if voltage incorrect
4. Replace Master Display Board.

INCORRECT DISPLAY

1. Check - 300VDC, + 100VDC - 100VDC at 4J7
2. Check for broken or shorted wires on 4J5, 4J6, 1J5, 1J6, 1J7
3. Replace Master Display Board

Section 6E - Place Diagnostics in Display Digits Test

Player Display Troubleshooting Chart

1 PLAYER DISPLAY INCORRECT/OFF

1. Check correct location of connector from Master Display Board.
2. Replace Player Display - if still incorrect, replace Master Display Board.

2-4 PLAYER DISPLAYS INCORRECT/OFF

1. Check correct location of connectors from Master Display Board
2. Check voltage - 300VDC, + 100VDC and - 100VDC on connector 4J7
3. If voltages are correct - replace Master Display Board.

USE EXTREME CAUTION WHEN MEASURING HIGH VOLTAGES !!!

Section 6F- Game Operation Troubleshooting

Put game in game over mode. Manually play game to verify problem. Go to diagnostic mode and read out functions by stepping through test 04. Review the game adjustments to verify that they are what is desired. Review game operation (Section 2).

Section 6G - Troubleshooting an inoperative machine or a machine that blows fuses.

Machine Inoperative

1. Remove plug from wall outlet and measure wall voltage.
2. With machine unplugged, check the line fuse, line cord, and ON/OFF switch with an Ohmmeter for continuity.
3. Check for any loose connections on line filter, ON/OFF switch.
4. Check that power connector to transformer is securely connected.
5. Check all fuses on power supply board.
6. Plug machine in, turn on and check voltage on power supply board fuses.

Machine Blows Fuse

1. Wall fuse or circuit breaker blows -
 - a) Disconnect wall plug.
 - b) Disconnect connector from line filter to transformer.
 - c) Check line cord with Ohmmeter for shorts.
 - d) Check varistor and line filter for shorts.
 - e) Plug cord in wall and see if wall fuse still blows - if yes, disconnect whatever else is on same wall plug circuit and recheck items (c) and (d) above.
2. Machine fuse blows -
 - a) Check for correct fuse rating.
 - b) Check varistor, line filter, line cord for shorts.
 - c) Disconnect connector from line filter to transformer and try another fuse.
 - d) If fuse still blows, do item a, b, c again.
 - e) If fuse does not blow, disconnect 3P1 and 3P2 plugs from the power supply board and reconnect plug from line filter to transformer.
 - f) If fuse blows, check transformer and both lamps and solenoid rectifiers for shorts.
 - g) If fuse does not blow, plug in 3P2 and 3P1 then try again. If fuse now blows, disconnect 3P3, 3P4, 3P5, 3P6, and try another fuse. If fuse still blows replace POWER SUPPLY.
 - h) If fuse doesn't blow, hook up 3P3, 3P4, 3P5, and 3P6 one at a time. If fuse blows when any one is plugged in, look for burned out solenoid, dead shorts, etc.

3. Individual Power Supply Fuse Blows

- a) Disconnect load from portion of the power supply that blows the fuse by disconnecting the appropriate plug.
 1. 3F1 (- 300VDC, + 100VDC, - 100VDC) disconnect 3P5
 2. 3F2 (+ 28VDC) disconnect 3P4, 3P3
 3. 3F3 (+ 18VDC) disconnect 3P4
 4. 3F4 (6.3VAC) disconnect 3P3
 5. 3F5 (+ 5VDC) disconnect 3P6
- b) If fuse still blows, replace POWER SUPPLY.
- c) If fuse does not blow, check for shorts in wiring, burned out solenoids, etc.

Section 6H - Game plays intermittently.

This usually indicates a power supply or CPU board problem. Check the +5VDC and the unregulated +5VDC on the CPU board and on the power supply. If the voltage is correct, attempt to run the CPU self tests in the diagnostics. (See Section 5) If the CPU self tests fail, remove the DRIVER BOARD and attempt to run the CPU self tests again. If the diagnostics now run, replace the DRIVER BOARD. Otherwise, replace the CPU Board.

Section 6I Game repeatedly comes on in diagnostic test 04, subtest 01.

This indicates that there has been either a battery failure or a CPU board failure. Measure the voltage across the batteries. If the voltage is below 3.0VDC, replace the batteries with Power ON and make any necessary game status changes if required. If the voltage is above 3.0VDC, run the CPU Self Test diagnostics. If CMOS RAM test fails, replace the CPU Board.

SECTION 7 INTERCONNECTION CHARTS

The following interconnection charts are used to identify the color and pin number of all the wires for all the components and typical wiring sketches for each type of circuit.

The following conventions are used throughout -

1. J1 is connector J1 on board 1.
J6 is connector J6 on board 3.
2. J designations refer to the male part of plug.
P designations refer to the female part of plug.
3. The prefix numbers are as follows:
 1. CPU Board
 2. Driver Board
 3. Power Supply Board
 4. Master Display Board
 5. Slave Display Board
 6. Back Box Miscellaneous
 7. Cabinet
 8. Playfield
 9. Insert Box

Refer to Figures 6, 7, 8 and 9 for the lamps matrix, the switch matrix, solenoid matrix and connector identification.

RED  YELLOW (B+)

TYPICAL WIRING

| | 1 YEL-BRN | 2 YEL-RED | 3 YEL-ORG | 4 YEL-BLK | 5 YEL-GRN | 6 YEL-BLU | 7 YEL-VIO | 8 YEL-GRY |
|--------------|--------------|--------------|--------------|--------------------|-------------------|--------------|---------------------|------------------------------------|
| 1 RED-BRN | | | | 5,000 | SPINNER | 6,000 BONUS | 30,000 BONUS | #1 PLAYER UP |
| 2 RED-BLK | | | | 10,000 | RIGHT DROP TARGET | 9,000 BONUS | 1 CAN PLAY | #2 PLAYER UP |
| 3 RED-ORN | | | | 20,000 | LEFT DROP TARGET | 12,000 BONUS | 2 CAN PLAY | #3 PLAYER UP |
| 4 RED-YEL | | | | 30,000 | DOUBLE BONUS | 15,000 BONUS | 3 CAN PLAY | #4 PLAYER UP |
| 5 RED-GRN | | | | LIGHT DOUBLE BONUS | SAME PLAYER SHOOT | 18,000 BONUS | 4 CAN PLAY | TILT |
| 6 RED-BLU | | | | SPECIAL | | 21,000 BONUS | MATCH | GAME OVER |
| 7 RED-VIO | | | | EXTRA BALL | | 24,000 BONUS | BALL IN PLAY | SAME PLAYER SHOOT AGAIN (BACK BOX) |
| 8 RED-GRY | | | | | 3,000 BONUS | 27,000 BONUS | CREDITS (PLAYFIELD) | HIGH SCORE |

FIGURE 6 - LIGHTS

TYPICAL WIRING

| | 1 | 2 | 3 | 4 | 5 | 6 | 7 | 8 |
|---|------------------|----------------------------|--------------------------------|---------|--------------------------|-----------------|------------------|---------|
| | GRN-BRN | GRN-RED | GRN-ORG | GRN-YEL | GRN-BLK | GRN-BLU | GRN-VIO | GRN-GRY |
| 1 | PLUMB TILT 1 | TOP ADVANCE BONUS TARGET 9 | BOTH DROP TARGETS DOWN 17 | 25 | LEFT JET BUMPER 33 | RIGHT CLOVER 41 | 49 | 57 |
| 2 | BALL ROLL TILT 2 | ADVANCE BONUS R.O. 10 | BOTTOM ADVANCE BONUS TARGET 18 | 26 | RIGHT JET BUMPER 34 | 42 | CENTER CLOVER 50 | 58 |
| 3 | CREDIT BUTTON 3 | LEFT REEL R.O. 11 | LEFT OUTSIDE R.O. 19 | 27 | LEFT REEL TARGET 35 | 43 | 51 | 59 |
| 4 | 25¢ SWITCH 4 | CENTER REEL R.O. 12 | LEFT INSIDE R.O. 20 | 28 | RIGHT KICKER 36 | 44 | 52 | 60 |
| 5 | 10¢ SWITCH 5 | RIGHT REEL R.O. 13 | RIGHT INSIDE R.O. 21 | 29 | TOP LEFT STAND UP 37 | 45 | 53 | 61 |
| 6 | 5¢ SWITCH 6 | SPINNER 14 | RIGHT OUTSIDE R.O. 22 | 30 | BOTTOM RIGHT STAND UP 38 | 46 | 54 | 62 |
| 7 | SLAM TILT 7 | LEFT DROP TARGET 15 | OUTHOLE 23 | 31 | CENTER REEL TARGET 39 | 47 | 55 | 63 |
| 8 | | RIGHT DROP TARGET 16 | LEFT KICKER 24 | 32 | RIGHT REEL TARGET 40 | 48 | 56 | 64 |

WHT-BRN

WHT-RED

WHT-ORG

WHT-YEL

WHT-GRN

WHT-BLU

WHT-VIO

WHT-GRY

FIGURE 7 - SWITCH

SPECIAL SOLENOIDS

SWITCH →
COIL →

| |
|--|
| ORN - BRN |
| BLU - BRN |
| 17 LEFT JET BUMPER G-23-750-DC |
| ORN - RED |
| BLU - RED |
| 18 RIGHT JET BUMPER G-23-750-DC |
| ORN - BLK |
| BLU - ORN |
| 19 RIGHT KICKER G-23-750-DC |
| ORN - YEL |
| BLU - YEL |
| 20 LEFT KICKER G-23-750-DC |
| ORN - GRN |
| BLU - GRN |
| 21 NOT USED |
| ORN - BLU |
| BLU - BLK |
| 22 NOT USED |
| ORN - VIO |
| BLU - VIO |
| RIGHT FLIPPER FL-20-300 33-1500-DC |
| ORN - GRY |
| BLU - GRY |
| LEFT FLIPPER FL-20-300 33-1500-DC |

SOLENOIDS

| PLAYFIELD | CABINET |
|---|---------------------------------------|
| GRY - BRN | BRN - BLK |
| 1 LEFT REEL B-29-1600-DC | 9 10 POINT CHIME B-29-1600-DC |
| GRY - RED | BRN - RED |
| 2 CENTER REEL B-29-1600-DC | 10 100 POINT CHIME B-29-1600-DC |
| GRY - ORN | BRN - ORN |
| 3 RIGHT REEL B-29-1600-DC | 11 1000 POINT CHIME B-29-1600-DC |
| GRY - YEL | BRN - YEL |
| 4 LEFT DROP TARGET RESET G-24-875-DC | 12 10,000 POINT CHIME B-29-1600-DC |
| GRY - GRN | BRN - GRN |
| 5 RIGHT DROP TARGET RESET G-24-875-DC | 13 NOISE DRUM BI-26-800-DC |
| GRY - BLU | BRN - BLU |
| 6 BALL RELEASE A-23-800-DC | 14 CREDIT KNOCKER A2-23-750-DC |
| GRY - VIO | BRN - VIO |
| 7 NOT USED | 15 BUZZER |
| GRY - BLK | BRN - GRY |
| 8 NOT USED | 16 COIN LOCKOUT M-35-4000-DC |

TYPICAL WIRING

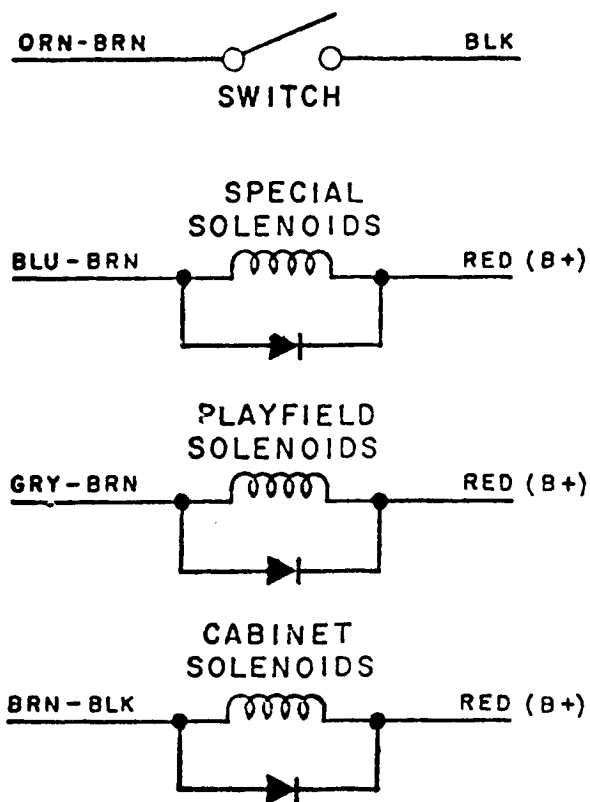
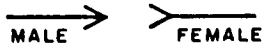

Figure 8

CONNECTOR LEGEND

ELECTRICAL SYMBOL



MALE
1 PIN
WHITE HOUSING
5A-9124
TERM. NO. 5A-9078



FEMALE
1 PIN
WHITE HOUSING
5A-9125
TERM. NO. 5A-9079



FEMALE

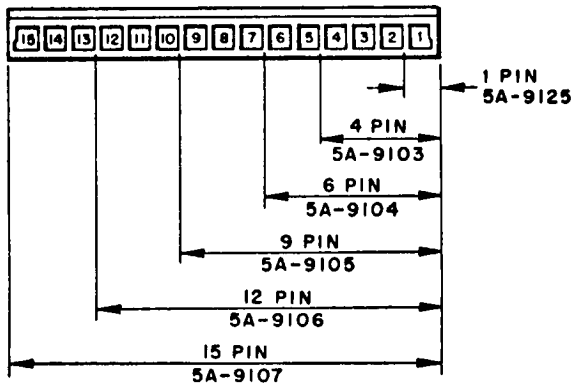

TERMINAL NO. 5A-9076

FEMALE

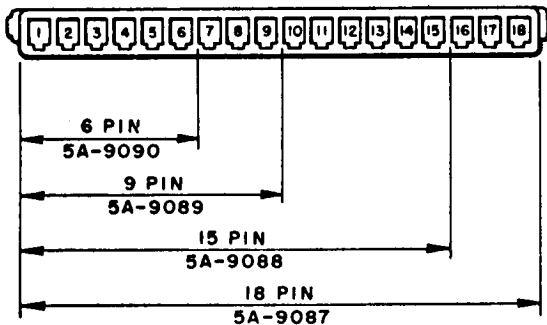

TERMINAL NO. 5A-9077

MALE
3 PIN

WHITE HOUSING
5A-9111
TERM. NO. 5A-9080

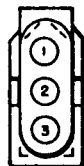

FEMALE
3 PIN

WHITE HOUSING
5A-9110
TERM. NO. 5A-9081

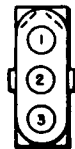

MALE
15 PIN

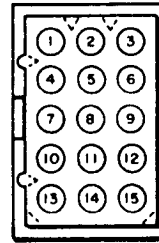

WHITE HOUSING
5A-9093
BLACK HOUSING
5A-9095
TERM. NO. 5A-9078

FEMALE
15 PIN

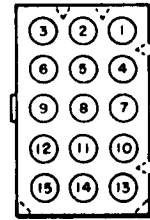

WHITE HOUSING
5A-9094
BLACK HOUSING
5A-9096
TERM. NO. 5A-9079

MALE
24 PIN

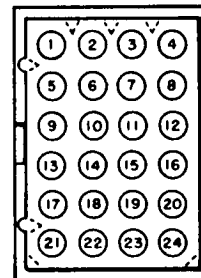

WHITE HOUSING
5A-9097
BLACK HOUSING
5A-9099
TERM. NO. 5A-9078

FEMALE
24 PIN

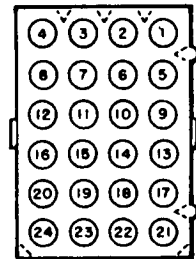

WHITE HOUSING
5A-9098
BLACK HOUSING
5A-9100
TERM. NO. 5A-9079

MALE
36 PIN

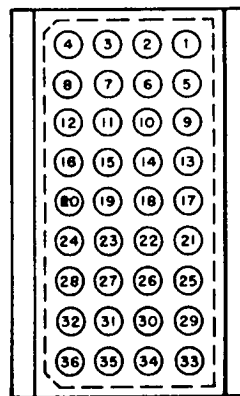

WHITE HOUSING
5A-9101
TERM. NO. 5A-9078

FEMALE
36 PIN

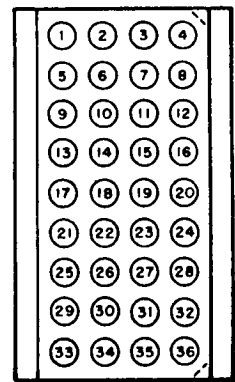

WHITE HOUSING
5A-9102
TERM. NO. 5A-9079

FIGURE 9

CPU BOARD

1J1 - INTERBOARD CONNECTOR

1P2 - LOGIC POWER BUS INPUT

| Pin | Wire Color | Function |
|-----|------------|-----------------------------------|
| 1 | Black | Logic Ground |
| 2 | Black | Logic Ground |
| 3 | Black | Logic Ground |
| 4 | Gray | Logic B+ (+ 5VDC) |
| 5 | Gray | Logic B+ (+ 5VDC) |
| 6 | Gray | Logic B+ (+ 5VDC) |
| 7 | Key | Key |
| 8 | N/C | Not Used |
| 9 | Gray-White | Logic B+ (+ 12V) (Unregulated) |

1P3 - DISPLAY BLANKING

| Pin | Wire Color | Function |
|-----|------------|------------------|
| 1 | N/C | Not Used |
| 2 | N/C | Not Used |
| 3 | Key | Key |
| 4 | Blue-White | Display Blanking |

1P4 - DIAGNOSTIC SWITCH INPUTS

| Pin | Wire Color | Function |
|-----|------------|----------------------|
| 1 | Key | Key |
| 2 | White | Diagnostic Common |
| 3 | Green | Diagnostic Advance |
| 4 | Blue | Diagnostic Auto/Man. |

1P5 - MASTER DISPLAY BCD OUTPUTS

| Pin | Wire Color | Function |
|-----|-------------|----------------|
| 1 | Blue-Yellow | Display BCD D1 |
| 2 | Blue-Orange | Display BCD C1 |
| 3 | Blue-Red | Display BCD B1 |
| 4 | Blue-Brown | Display BCD A1 |
| 5 | Blue-Gray | Display BCD D2 |
| 6 | Key | Key |
| 7 | Blue-Violet | Display BCD C2 |
| 8 | Blue-Black | Display BCD B2 |
| 9 | Blue-Green | Display BCD A2 |

1P6 - MASTER DISPLAY STROBE OUTPUTS

| Pin | Wire Color | Function |
|-----|---------------|--------------------|
| 1 | Violet-Gray | Display Strobe #16 |
| 2 | Violet-Black | Display Strobe #15 |
| 3 | Violet-Blue | Display Strobe #14 |
| 4 | Violet-Green | Display Strobe #13 |
| 5 | Violet-Yellow | Display Strobe #12 |
| 6 | Violet-Orange | Display Strobe #11 |
| 7 | Key | Key |
| 8 | Violet-Red | Display Strobe #10 |
| 9 | Violet-Brown | Display Strobe # 9 |

1P7 - MASTER DISPLAY STROBE OUTPUTS

| Pin | Wire Color | Function |
|-----|--------------|--------------------|
| 1 | Brown-Gray | Display Strobe # 8 |
| 2 | Brown-Violet | Display Strobe # 7 |
| 3 | Brown-Blue | Display Strobe # 6 |
| 4 | Brown-Green | Display Strobe # 5 |
| 5 | Brown-Yellow | Display Strobe # 4 |
| 6 | Brown-Orange | Display Strobe # 3 |
| 7 | Brown-Red | Display Strobe # 2 |
| 8 | Key | Key |
| 9 | Brown-Black | Display Strobe # 1 |

DRIVER BOARD

2P1 - INTERBOARD CONNECTOR

2P2 - SWITCH STROBE DRIVE

| Pin | Wire Color | Function |
|-----|--------------|-------------------|
| 1 | N/C | Not Used |
| 2 | Green-Violet | Switch Strobe # 7 |
| 3 | Green-Blue | Switch Strobe # 6 |
| 4 | Key | Key |
| 5 | Green-Black | Switch Strobe # 5 |
| 6 | Green-Yellow | Switch Strobe # 4 |
| 7 | Green-Orange | Switch Strobe # 3 |
| 8 | Green-Red | Switch Strobe # 2 |
| 9 | Green-Brown | Switch Strobe # 1 |

2P3 - SWITCH ROW INPUTS

| Pin | Wire Color | Function |
|-----|--------------|-------------------|
| 1 | White-Gray | Switch Return # 8 |
| 2 | Key | Key |
| 3 | White-Violet | Switch Return # 7 |
| 4 | White-Blue | Switch Return # 6 |
| 5 | White-Green | Switch Return # 5 |
| 6 | White-Yellow | Switch Return # 4 |
| 7 | White-Orange | Switch Return # 3 |
| 8 | White-Red | Switch Return # 2 |
| 9 | White-Brown | Switch Return # 1 |

2P4 - LAMP POWER BUS

| Pin | Wire Color | Function |
|-----|------------|----------|
| 1 | Blue | Lamp B + |
| 2 | Blue | Lamp B + |
| 3 | Key | Key |
| 4 | Blue | Lamp B + |
| 5 | Blue | Lamp B + |
| 6 | N/C | Not Used |
| 7 | Blue | Lamp B + |
| 8 | Blue | Lamp B + |
| 9 | Blue | Lamp B + |

2P5 - LAMP COLUMN DRIVE

| Pin | Wire Color | Function |
|-----|---------------|-----------------|
| 1 | Yellow-Violet | Lamp Column # 7 |
| 2 | Yellow-Gray | Lamp Column # 8 |
| 3 | Yellow-Green | Lamp Column # 5 |
| 4 | Key | Key |
| 5 | Yellow-Blue | Lamp Column # 6 |
| 6 | N/C | Not Used |
| 7 | Yellow-Black | Lamp Column # 4 |
| 8 | N/C | Not Used |
| 9 | N/C | Not Used |

2P6 - LAMP GROUNDS

| Pin | Wire Color | Function |
|-----|------------|-------------|
| 1 | Black | Lamp Ground |
| 2 | Key | Key |
| 3 | Black | Lamp Ground |
| 4 | Black | Lamp Ground |
| 5 | N/C | Not Used |
| 6 | Black | Lamp Ground |
| 7 | Black | Lamp Ground |
| 8 | Black | Lamp Ground |
| 9 | Black | Lamp Ground |

2P7 - LAMP ROW DRIVE

| Pin | Wire Color | Function |
|-----|------------|--------------|
| 1 | Red-Brown | Lamp Row # 1 |
| 2 | Red-Black | Lamp Row # 2 |
| 3 | Red-Orange | Lamp Row # 3 |
| 4 | Red-Yellow | Lamp Row # 4 |
| 5 | Red-Green | Lamp Row # 5 |
| 6 | Red-Blue | Lamp Row # 6 |
| 7 | Key | Key |
| 8 | Red-Gray | Lamp Row # 8 |
| 9 | Red-Violet | Lamp Row # 7 |

DRIVER BOARD

2P8 - LOGIC POWER BUS INPUT

| Pin | Wire Color | Function |
|-----|------------|---------------------|
| 1 | Black | Logic Ground |
| 2 | Black | Logic Ground |
| 3 | Black | Logic Ground |
| 4 | Black | Logic Ground |
| 5 | Key | Key |
| 6 | Gray | Logic B + (+ 5 VDC) |
| 7 | Gray | Logic B + (+ 5 VDC) |
| 8 | Gray | Logic B + (+ 5 VDC) |
| 9 | Gray | Logic B + (+ 5 VDC) |

2P9 - CABINET SOLENOIDS DRIVE

| Pin | Wire Color | Function |
|-----|--------------|-----------------------------|
| 1 | Brown-Orange | Coil #11 1000 Point Chime |
| 2 | Brown-Yellow | Coil #12 10,000 Point Chime |
| 3 | Brown-Green | Coil #13 Noise Unit |
| 4 | Brown-Blue | Coil #14 Knocker |
| 5 | Brown-Violet | Coil #15 Buzzer |
| 6 | Brown-Gray | Coil #16 Coin Lockout |
| 7 | Brown-Red | Coil #10 100 Point Chime |
| 8 | Key | Key |
| 9 | Brown-Black | Coil # 9 10 Point Chime |

2P10 - SOLENOID GROUNDS

| Pin | Wire Color | Function |
|-----|------------|-----------------|
| 1 | Black | Solenoid Ground |
| 2 | Black | Solenoid Ground |
| 3 | Black | Solenoid Ground |
| 4 | Black | Solenoid Ground |
| 5 | Key | Key |
| 6 | N/C | Not Used |
| 7 | Black | Solenoid Ground |
| 8 | Black | Solenoid Ground |
| 9 | Black | Solenoid Ground |

2P11 - PLAYFIELD SOLENOIDS DRIVE

| Pin | Wire Color | Function |
|-----|-------------|-------------------------------------|
| 1 | N/C | Not Used |
| 2 | N/C | Not Used |
| 3 | Gray-Blue | Coil # 6 Ball Release |
| 4 | Gray-Brown | Coil # 1 Left Reel |
| 5 | Gray-Red | Coil # 2 Center Reel |
| 6 | Key | Key |
| 7 | Gray-Orange | Coil # 3 Right Reel |
| 8 | Gray-Yellow | Coil # 4 Left Drop Target Reset |
| 9 | Gray-Green | Coil # 5 Right Drop Target Reset |

| Pin | Wire Color | Function |
|-----|---------------|----------------------|
| 1 | Orange-Violet | Right Flipper Enable |
| 2 | Orange-Gray | Left Flipper Enable |
| 3 | Blue-Orange | Right Kicker |
| 4 | Blue-Red | Right Jet Bumper |
| 5 | Key | Key |
| 6 | Blue-Yellow | Left Kicker |
| 7 | Blue-Brown | Left Jet Bumper |
| 8 | N/C | Not Used |
| 9 | N/C | Not Used |

2P13 - SPECIAL SWITCH INPUTS

| Pin | Wire Color | Function |
|-----|---------------|----------------------|
| 1 | Key | Key |
| 2 | Orange-Black | Right Kicker Sw. |
| 3 | Orange-Red | Right Jet Bumper Sw. |
| 4 | Orange-Yellow | Left Kicker Sw. |
| 5 | Orange-Brown | Left Jet Bumper Sw. |
| 6 | N/C | Not Used |
| 7 | N/C | Not Used |
| 8 | N/C | Not Used |
| 9 | N/C | Not Used |

POWER SUPPLY

3P1 - POWER BUS INPUTS

| Pin | Wire Color | Function |
|-----|------------|----------------------|
| 1 | Violet | Lamps (+ 18 VDC) |
| 2 | Orange | Solenoids (+ 28 VDC) |
| 3 | Yellow | 6.3 VAC |
| 4 | White | 90 VAC |
| 5 | N/C | Not Used |
| 6 | Yellow | 6.3 VAC |
| 7 | N/C | Not Used |
| 8 | N/C | Not Used |
| 9 | White | 90 VAC |
| 10 | Gray | 18.7 VAC C.T. |
| 11 | Gray | 18.7 VAC C.T. |
| 12 | Gray White | 18.7 VAC C.T. |

3P2 - POWER BUS INPUTS

| Pin | Wire Color | Function |
|-----|------------|------------------|
| 1 | N/C | Not Used |
| 2 | N/C | Not Used |
| 3 | Black | Solenoid Rect. - |
| 4 | N/C | Not Used |
| 5 | N/C | Not Used |
| 6 | Black | Lamp Rect. - |

3P3 - DISPLAY LAMPS & SOLENOID POWER BUS

| Pin | Wire Color | Function |
|-----|--------------|------------------------|
| 1 | Yellow-White | 6.3 VAC Display Lamps |
| 2 | Yellow-White | 6.3 VAC Display Lamps |
| 3 | Black | Ground |
| 4 | Yellow | 6.3 VAC Display Lamps |
| 5 | Yellow | 6.3 VAC Display Lamps |
| 6 | Red | Solenoid B+ (+ 28 VDC) |
| 7 | Red | Solenoid B+ (+ 28 VDC) |
| 8 | N/C | Not Used |
| 9 | Key | Key |

3P4 - LAMP & SOLENOID POWER BUS

| Pin | Wire Color | Function |
|-----|------------|--------------------|
| 1 | Black | Ground |
| 2 | Black | Ground |
| 3 | Black | Ground |
| 4 | Black | Ground |
| 5 | Blue | Lamp B+ (+ 16 VDC) |
| 6 | Blue | Lamp B+ (+ 16 VDC) |
| 7 | Blue | Lamp B+ (+ 16 VDC) |
| 8 | Blue | Lamp B+ (+ 16 VDC) |
| 9 | Black | Ground |
| 10 | Black | Ground |
| 11 | Black | Ground |
| 12 | Black | Ground |

3P5 - DISPLAY POWER BUS

| Pin | Wire Color | Function |
|-----|------------------|--------------------|
| 1 | Black | Ground |
| 2 | None | - 300 VDC |
| 3 | Orange & Wht-Blk | - 100 VDC |
| 4 | Brown | + 100 VDC |
| 5 | N/C Key | Not Used |
| 6 | Gray | Logic B+ (+ 5 VDC) |

3P6 - LOGIC POWER BUS

| Pin | Wire Color | Function |
|-----|------------|-------------------------------|
| 1 | N/C | Not Used |
| 2 | N/C | Not Used |
| 3 | N/C | Not Used |
| 4 | N/C | Not Used |
| 5 | Key | Key |
| 6 | Gray-White | Logic + (+ 12V. Un-regulated) |
| 7 | Gray | Logic B+ (+ 5V.) |
| 8 | Gray | Logic B+ (+ 5V.) |
| 9 | Gray | Logic B+ (+ 5V.) |
| 10 | Gray | Logic B+ (+ 5V.) |
| 11 | Black | Ground |
| 12 | Black | Ground |
| 13 | Black | Ground |
| 14 | Black | Ground |
| 15 | Black | Ground |

MASTER DISPLAY

4P5 - MASTER DISPLAY STROBE INPUTS

| Pin | Wire Color | Function |
|-----|----------------|------------|
| 1 | N/C | Not Used |
| 2 | Brown-Gray-1 | Strobe # 8 |
| 3 | Brown-Violet-1 | Strobe # 7 |
| 4 | Violet-Gray | Strobe #16 |
| 5 | Violet-Black | Strobe #15 |
| 6 | Brown-Black-1 | Strobe # 1 |
| 7 | Brown-Red-1 | Strobe # 2 |
| 8 | Brown-Orange-1 | Strobe # 3 |
| 9 | Brown-Yellow-1 | Strobe # 4 |
| 10 | Brown-Green-1 | Strobe # 5 |
| 11 | Brown-Blue-1 | Strobe # 6 |
| 12 | Violet-Red | Strobe #10 |
| 13 | Violet-Orange | Strobe #11 |
| 14 | Violet-Blue | Strobe #14 |
| 15 | Violet-Brown | Strobe # 9 |
| 16 | Violet-Green | Strobe #13 |
| 17 | Violet-Yellow | Strobe #12 |
| 18 | N/C | Not Used |

4P6 - MASTER DISPLAY BCD INPUTS

| Pin | Wire Color | Function |
|-----|---------------|----------|
| 1 | Blue-Red-1 | B1 |
| 2 | Blue-Orange-1 | C1 |
| 3 | Blue-White | Blanking |
| 4 | Blue-Yellow-1 | D1 |
| 5 | Blue-Brown-1 | A1 |
| 6 | Blue-Black-1 | B2 |
| 7 | Blue-Violet-1 | C2 |
| 8 | Blue-Gray-1 | D2 |
| 9 | Blue-Green-1 | A2 |

4P7 - MASTER DISPLAY POWER INPUTS

| Pin | Wire Color | Function |
|-----|-------------|----------------------|
| 1 | White-Black | Keep Alive – 100 VDC |
| 2 | Brown | +100 VDC |
| 3 | Gray | Logic B+ + 5VDC |
| 4 | N/C | Not Used |
| 5 | Black | Ground |
| 6 | Orange | – 100 VDC |

PLAYER DISPLAYS

5P1 - PLAYER # 1 SLAVE DISPLAY

| Pin | Wire Color | Function |
|-----|-----------------|------------|
| 1 | Blue-1 | f |
| 2 | Violet | g |
| 3 | Brown-Blue-2 | 100,000's |
| 4 | Green-1 | e |
| 5 | Yellow-1 | d |
| 6 | Brown-Green-2 | 10,000's |
| 7 | Brown-Yellow-2 | 1,000's |
| 8 | N/C | Not Used |
| 9 | Jumper to Pin 3 | |
| 10 | White-Black | Keep Alive |
| 11 | Brown-Orange-2 | 100's |
| 12 | Brown-Red-2 | 10's |
| 13 | N/C | Key |
| 14 | Orange-1 | c |
| 15 | Brown-Black-2 | Units |
| 16 | Red-1 | b |
| 17 | Brown-1 | a |
| 18 | N/C | Not Used |

5P3 - PLAYER # 3 SLAVE DISPLAY

| Pin | Wire Color | Function |
|-----|-----------------|------------|
| 1 | Blue-2 | f |
| 2 | Violet-1 | g |
| 3 | Orange-Violet-1 | 100,000's |
| 4 | Green-2 | e |
| 5 | Yellow-2 | d |
| 6 | Orange-Blue-1 | 10,000's |
| 7 | Orange-Green-1 | 1,000's |
| 8 | N/C | Not Used |
| 9 | Jumper to Pin 3 | |
| 10 | White-Black | Keep Alive |
| 11 | Orange-Yellow-1 | 100's |
| 12 | Orange-Red-1 | 10's |
| 13 | N/C | Key |
| 14 | Orange-2 | c |
| 15 | Orange-Brown-1 | Units |
| 16 | Red-2 | b |
| 17 | Brown-2 | a |
| 18 | N/C | Not Used |

5P2 - PLAYER # 2 SLAVE DISPLAY

| Pin | Wire Color | Function |
|-----|-----------------|------------|
| 1 | Blue-1 | f |
| 2 | Violet | g |
| 3 | Red-Blue-1 | 100,000's |
| 4 | Green-1 | e |
| 5 | Yellow-1 | d |
| 6 | Red-Green-1 | 10,000's |
| 7 | Red-Yellow-1 | 1,000's |
| 8 | N/C | Not Used |
| 9 | Jumper to Pin 3 | |
| 10 | White-Black | Keep Alive |
| 11 | Red-Orange-1 | 100's |
| 12 | Red-Brown-1 | 10's |
| 13 | N/C | Key |
| 14 | Orange-1 | c |
| 15 | Red-Black-1 | Units |
| 16 | Red-1 | b |
| 17 | Brown-1 | a |
| 18 | N/C | Not Used |

5P4 - PLAYER # 4 SLAVE DISPLAY

| Pin | Wire Color | Function |
|-----|-----------------|------------|
| 1 | Blue-2 | f |
| 2 | Violet-1 | g |
| 3 | Yellow-Violet-1 | 100,000's |
| 4 | Green-2 | e |
| 5 | Yellow-2 | d |
| 6 | Yellow-Blue-1 | 10,000's |
| 7 | Yellow-Green-1 | 1,000's |
| 8 | N/C | Not Used |
| 9 | Jumper to Pin 3 | |
| 10 | White-Black | Keep Alive |
| 11 | Yellow-Orange-1 | 100's |
| 12 | Yellow-Red-1 | 10's |
| 13 | N/C | Key |
| 14 | Orange-2 | c |
| 15 | Yellow-Brown-1 | Units |
| 16 | Red-2 | b |
| 17 | Brown-2 | a |
| 18 | N/C | Not Used |

BACK BOX MISCELLANEOUS

6P1/6J1 SWITCHED AC INPUT

| Pin | Color | Function |
|-----|-----------|----------|
| 1 | White-Red | AC |
| 2 | N/C | |
| 3 | White-Red | AC |

6P2/6J2 FLIPPER POWER

| Pin | Color | Function |
|-----|-----------|-------------|
| 1 | White-Red | Flipper B + |

CABINET

7P1/7J1 CABINET SOLENOIDS & SWITCHED (White 36 Pin)

| Pin | Color | Function |
|-------|---------------|-----------------------------|
| 1 | Yellow | 6.3 VAC Display Lamps |
| 2 | Yellow-White | 6.3 VAC Display Lamps |
| 3 | Red | Solenoid B + |
| 4 | White | Diagnostic Common |
| 5 | Green | Diagnostic Advance |
| 6 | Blue | Diagnostic Auto/Man. |
| 7 | Orange-Violet | Right Flipper Switch |
| 8 | Blue-Violet | Right Flipper Switch |
| 9 | Orange-Gray | Left Flipper Switch |
| 10 | Blue-Gray | Left Flipper Switch |
| 11 | Brown-Black | Coil # 9 10 Point Chime |
| 12 | Brown-Red | Coil #10 100 Point Chime |
| 13 | Brown-Orange | Coil #11 1000 Point Chime |
| 14 | Brown-Yellow | Coil #12 10,000 Point Chime |
| 15 | Brown-Green | Coil #13 Noise Unit |
| 16 | Brown-Blue | Coil #14 Knocker |
| 17 | Brown-Violet | Coil #15 Buzzer |
| 18 | Brown-Gray | Coil #16 Coin Lockout |
| 19 | Green-Brown | Switch Column # 1 |
| 20 | N/C | Not Used |
| 21 | White-Brown | Switch Row # 1 |
| 22 | White-Red | Switch Row # 2 |
| 23 | White-Orange | Switch Row # 3 |
| 24 | White-Yellow | Switch Row # 4 |
| 25 | White-Green | Switch Row # 5 |
| 26 | White-Blue | Switch Row # 6 |
| 27 | White-Violet | Switch Row # 7 |
| 28-36 | N/C | Not Used |

7P2/7J2 CABINET SWITCHES & DISPLAY LAMPS (White) (15 Pin)

| Pin | Color | Function |
|-----|--------------|-----------------------|
| 1 | Yellow | 6.3 VAC Display Lamps |
| 2 | Yellow-White | 6.3 VAC Display Lamps |
| 3 | Red | Coil B + |
| 4 | Brown-Gray | Coil #16 Coin Lockout |
| 5 | N/C | Not Used |
| 6 | Green-Brown | Switch Column # 1 |
| 7 | N/C | Not Used |
| 8 | White-Yellow | Switch Row # 4 |
| 9 | White-Green | Switch Row # 5 |
| 10 | White-Blue | Switch Row # 6 |
| 11 | White-Violet | Switch Row # 7 |
| 12 | N/C | Not Used |
| 13 | White | Diagnostic Common |
| 14 | Green | Advance |
| 15 | Blue | Auto/Manual |

PLAYFIELD

8P1/8J1 PLAYFIELD SWITCHES (White) (15 Pin)

| Pin | Color | Function |
|-----|--------------|-------------------|
| 1 | Green-Red | Switch Column # 2 |
| 2 | Green-Orange | Switch Column # 3 |
| 3 | Green-Yellow | Switch Column # 4 |
| 4 | Green-Black | Switch Column # 5 |
| 5 | Green-Blue | Switch Column # 6 |
| 6 | Green-Violet | Switch Column # 7 |
| 7 | N/C | Not Used |
| 8 | White-Brown | Switch Row # 1 |
| 9 | White-Red | Switch Row # 2 |
| 10 | White-Orange | Switch Row # 3 |
| 11 | White-Yellow | Switch Row # 4 |
| 12 | White-Green | Switch Row # 5 |
| 13 | White-Blue | Switch Row # 6 |
| 14 | White-Violet | Switch Row # 7 |
| 15 | White-Gray | Switch Row # 8 |

8P2/8J2 PLAYFIELD LAMPS (White) (24 Pin)

| Pin | Color | Function |
|-------|---------------|-----------------------|
| 1 | Yellow | 6.3 VAC Display Lamps |
| 2 | Yellow-White | 6.3 VAC Display Lamps |
| 3 | N/C | Not Used |
| 4 | N/C | Not Used |
| 5 | N/C | Not Used |
| 6 | Yellow-Black | Lamp Column # 4 |
| 7 | Yellow-Green | Lamp Column # 5 |
| 8 | Yellow-Blue | Lamp Column # 6 |
| 9 | Yellow-Violet | Lamp Column # 7 |
| 10 | N/C | Not Used |
| 11 | Red-Brown | Lamp Row # 1 |
| 12 | Red-Black | Lamp Row # 2 |
| 13 | Red-Orange | Lamp Row # 3 |
| 14 | Red-Yellow | Lamp Row # 4 |
| 15 | Red-Green | Lamp Row # 5 |
| 16 | Red-Blue | Lamp Row # 6 |
| 17 | Red-Violet | Lamp Row # 7 |
| 18 | Red-Gray | Lamp Row # 8 |
| 19-24 | N/C | Not Used |

8P3/8J3 PLAYFIELD SOLENOIDS, SPECIAL SWITCHES (Black) (24 Pin)

| Pin | Color | Function |
|-----|---------------|-------------------------------------|
| 1 | Red | Coil B + |
| 2 | Black | Ground (Special Switch Common) |
| 3 | Blue-Violet | Right Flipper Coil |
| 4 | Blue-Gray | Left Flipper Coil |
| 5 | Orange-Brown | Left Jet Bumper Sw. |
| 6 | Orange-Red | Right Jet Bumper Sw. |
| 7 | Orange-Black | Right Kicker Sw. |
| 8 | Orange-Yellow | Left Kicker Sw. |
| 9 | N/C | Not Used |
| 10 | N/C | Not Used |
| 11 | Blue-Brown | Left Jet Bumper Coil |
| 12 | Blue-Red | Right Jet Bumper Coil |
| 13 | Blue-Orange | Right Kicker Coil |
| 14 | Blue-Yellow | Left Kicker Coil |
| 15 | N/C | Not Used |
| 16 | N/C | Not Used |
| 17 | Gray-Brown | Coil # 1 Left Reel |
| 18 | Gray-Red | Coil # 2 Center Reel |
| 19 | Gray-Orange | Coil # 3 Right Reel |
| 20 | Gray-Yellow | Coil # 4 Left Drop Target Reset |
| 21 | Gray-Green | Coil # 5 Right Drop Target Reset |
| 22 | Gray-Blue | Coil # 6 Ball Release |
| 23 | N/C | Not Used |
| 24 | N/C | Not Used |

INSERT BOX

9P1/9J1 INSERT DOOR LAMP CONNECTOR (Black) (15 Pin)

| Pin | Color | Function |
|-----|---------------|-----------------------|
| 1 | Yellow | 6.3 VAC Display Lamps |
| 2 | Yellow-White | 6.3 VAC Display Lamps |
| 3 | N/C | Not Used |
| 4 | N/C | Not Used |
| 5 | N/C | Not Used |
| 6 | Yellow-Violet | Lamp Column # 7 |
| 7 | Yellow-Gray | Lamp Column # 8 |
| 8 | Red-Brown | Lamp Row # 1 |
| 9 | Red-Black | Lamp Row # 2 |
| 10 | Red-Orange | Lamp Row # 3 |
| 11 | Red-Yellow | Lamp Row # 4 |
| 12 | Red-Green | Lamp Row # 5 |
| 13 | Red-Blue | Lamp Row # 6 |
| 14 | Red-Violet | Lamp Row # 7 |
| 15 | Red-Gray | Lamp Row # 8 |

Section 8 Mechanical Adjustments

Switches

There are different types of switches used throughout the game. The switch blades are made of a highly conductive spring type metal in various lengths, thickness, and form. Each switch is designed to satisfy specific operation conditions such as bounce, current carrying capacity, speed of operation, etc. Therefore, it is important to replace a blade with another of the same kind. When adjusting blades, never kink or bend sharply, as this causes fatigue which leads to fractures. Adjust blades with a sweeping, bowing motion, with a switch adjusting tool or duck bill pliers.

When switch adjustments are called for, before forming blades on any machine, check that the screws holding the switch stacks are down very tight. This is recommended because plastic spacers in the switch stacks will occasionally shrink by drying out causing a poor adjustment.

With the exception of a few instances, all blade type switches should have at least 1/32 inch between the contact points and should follow thru for at least 1/32 inch beyond the point at which the contacts close. This follow thru action provides a wiping motion between the contacts keeping them clean and insuring good contact between the points.

To adjust blade type switches properly, first adjust the actuating blade (usually, the longer one) with relation to the part that it contacts. Then set the gap and follow thru by adjusting the other blade.

Switch Contacts

With the exception of flipper button and end of stroke switches, all blade switch contacts are gold-plated and must NOT be burnished or filed. To clean the contacts, close them on a clean piece of paper (e.g. business card) and wipe gently until the contacts are clean.

For the flipper button switches, remove tarnish by filing with a contact file and then burnishing. Do the same for the flipper end-of-stroke switch contacts.

DO NOT file or burnish any other contacts.

Severely pitted contacts should be replaced as an assembly. Switch contacts should only be adjusted when they cause a malfunction or do not score properly.

Roll-Over Lane Switches

Playfield lane switches are operated by a roll-over wire form which is actuated by the ball. Before the switch is adjusted, the wire should be centered in the playfield slot. The long blade closest to the playfield should be adjusted to hold the wire form up. Check this condition with the playfield down. Then, with the playfield up, adjust the short blade for 1/16 inch clearance. Depress the wire form to its maximum depression with the ball and check for 1/32 inch follow thru. To prevent switch vibration a back-up blade is used. It should be parallel and just barely in contact with the short blade.

Flipper

Flippers are controlled by the flipper pushbuttons to either side of the cabinet. The flipper coil consists of two windings: A pull-in winding and a lighter gauge hold-in winding. The hold-in winding is normally bypassed by a closed switch.

The pull-in winding produces a strong stroke. However, if this winding were to remain energized by the player it would overheat. To reduce this high current, the hold winding is put in series with the pull-in winding by opening the end-of-stroke switch.

This switch should be adjusted so that the long blade is moved by the flipper pawl assembly for about the last 1/8 inch of movement. With the plunger completely depressed manually, the short blade should be adjusted for a 3/32 inch gap and 1/32 inch follow thru.

NEVER LUBRICATE THE PLUNGER. The only lubrication required is the link assembly with the special coin machine lubricant.

Weak or sluggish flipper action can be due to dirty or improperly adjusted contact points, worn out coil sleeve, loose or broken bushing, incorrect coil or shorted diodes, worn out fiber links, weak or broken return spring, loose coil between the retaining bracket and coil stop, or loose screws. Check all of the above to correct.

Plumb Bob Tilt

The plumb bob tilt can be made more sensitive by raising the plumb bob on the shaft. It can also be made less sensitive by lowering the bob on the shaft.

Super Slam Tilt

The super slam tilt on the coin door is adjustable. The normal adjustment is contacts open 1/32 inch.

Playfield Tilt

The playfield tilt is adjustable by forming the switch contacts. Closing the gap will make the tilt more sensitive.

Roll Tilt

The roll tilt in the cabinet box can be raised (more sensitive) or lowered (less sensitive) at the front pivot slot.

Section 9

Spare Parts

The parts used on the solid state LUCKY SEVEN are standard Williams parts. Refer to the accompanying sketch for identification of various playfield parts and adjustments.

Playfield Care

The playfield on this machine has an improved finish with excellent wearing properties. **DO NOT** clean the board with water, water soap solutions, or harsh abrasives. Avoid using steel wool, kitchen cleansers, or abrasive hand soap. Water will weaken the adhering of the paint to the board and abrasives shorten the board life.

A wax base cleaner with negligible abrasive qualities used lightly, but frequently, will extend board life to its full capabilities.

Backglass Removal

Unlock the key lock (Figure 1, - No. 4) then lift the glass up and out.

LUCKY SEVEN

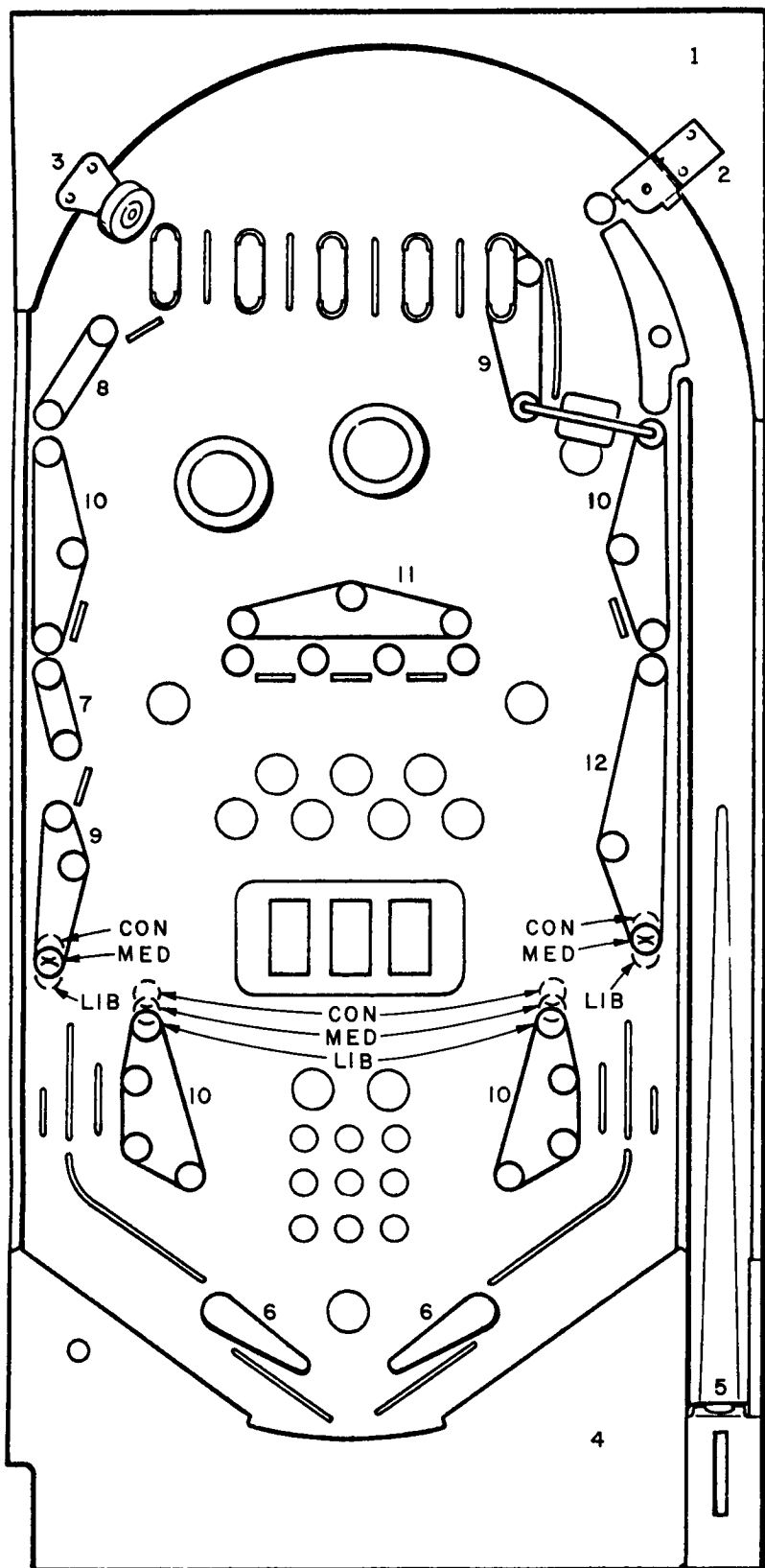

PLAYFIELD PARTS

| <u>PART NO.</u> | <u>DESCRIPTION</u> |
|-----------------|-----------------------------|
| 1. | IC-2852-476 TOP ARCH |
| 2. | A-4817 BALL GATE |
| 3. | A-4741 REBOUND |
| 4. | ID-5573 BOTTOM ARCH |
| 5. | 23A-6327 BALL SHOOTER TI |
| 6. | 23A-6519-4 FLIPPER RINGS |
| 7. | 23A-6303 RUBBER RING 1 1/4" |
| 8. | 23A-6304 RUBBER RING 1 1/2" |
| 9. | 23A-6305 RUBBER RING 2" |
| 10. | 23A-6306 RUBBER RING 2 3/8" |
| 11. | 23A-6307 RUBBER RING 2 7/8" |
| 12. | 23A-6309 RUBBER RING 3 7/8" |

ABBREVIATIONS:

CON. - CONSERVATIVE

MED. - MEDIUM

LIB. - LIBERAL

SUGGESTED SCORE CARDS

5 BALL 16C-480-21

3 BALL 16C-480-37

EXTRA BALL PLAY

5 BALL 16C-480-55

3 BALL 16C-480-51