

# Service Bulletin N<sup>o</sup> 106

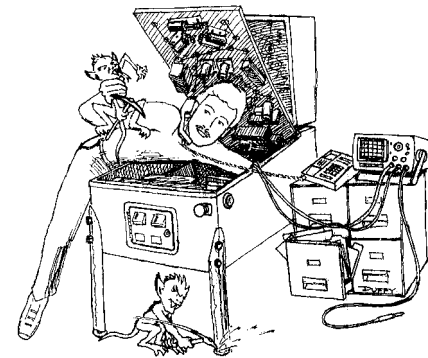

Joe Blackwell  
Technical Support Manager

Eric Winston  
Technical Support Engineer

Doug Lemons  
Technical Support Engineer

Jay Alfer  
Technical Support Administrator

TO: Parts & Service Managers

For :

DATE: June 2, 1998

SUBJ: Large Dot Display (192 X 64)  
Optional Enhancement  
Cable Wiring Harness  
Update Kit  
(ask for SPI N<sup>o</sup> 500-6326-00)



## Explanation:

The **Large Dot Matrix Display (192 X 64) Board (520-5075-00)** may *Blank-Out* and/or *Resets* intermittently. In normal operation, do not confuse a momentary "blank" screen inbetween completed functions in the *Attract Mode, Game Play and Diagnostics (Portals™ Service Menu)*. Our **Display Controller Board** (for 192 X 64 Dot Matrixes) (520-5092-01) utilizes a 68000 Micro Processor which runs at 12Mhz. It "likes" its' 5 volts to be "5 VOLTS" or darn near close. One of the things that typically happens with *older (aging)* equipment is they begin to develop "bad connections" and Power Supply Lines tend to *drop more voltage*, leaving *less power available* for the device it's running.

We have developed the **Large Dot Display (192 X 64) Optional Enhancement Cable Wiring Harness Update Kit (500-6326-00)** to improve the efficiency with which the harness supplies current & voltage to the **Dot Matrix Display Board (192 X 64)** and the **Display Controller Board**, thus eliminating the **Blanking and/or Resetting problem** due to *old age and/or bad connections*.

This "kit" takes less than ten minutes to install and is very inexpensive. We highly recommend using this "kit" if you have one of the aforementioned symptoms.

The **Large Dot Display (192 X 64) Optional Enhancement Cable Wiring Harness Update Kit (SPI N<sup>o</sup>: 500-6326-00)** is **now available** for your purchase. **This kit (assembled Cable Wiring Harness) contains:**

- 5' 18g Red Wire (looped)
- 5' 18g Black Wire (looped)
- 5-Pin IDC .156 Hdr. Molex Connector (both wire ends terminated @ Pins-1 & -3, Keyed @ Pin-2)
- Wire Ties (4 ea. to keep wires neat)
- This Service Bulletin N<sup>o</sup> 106 (Explanation & Procedure)

**Procedure**  (When performing installation ensure game is powered off!)

**STEP 1** Locate the Connector at **CN6** on the **Power Supply Board (520-5047-03)** (See **Fig. 1**) and remove from the board. You will notice at **Pin-1** and **Pin-10** that there are no wires connected.

**PLEASE NOTE:** For **Cut the Cheese/Sega Sports**, you may have to use **CN5, Pin-2** for **Black Wire (Gnd)** & **Pin-8** for **Red Wire (+5v)** in lieu of **CN6, Pin-1 & Pin-10** if there are existing wires at these 2 Pin locations.

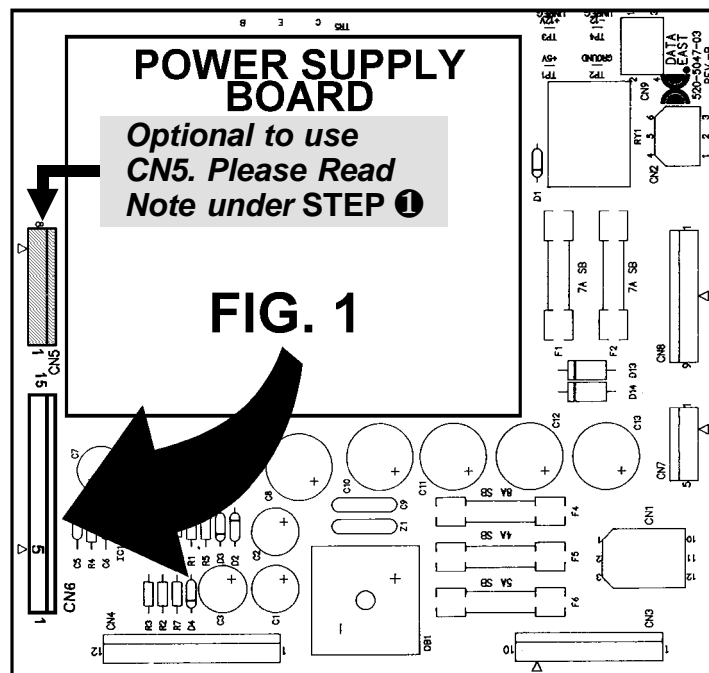

Continued Next Page.

**Procedure Continued**

**STEP 2** Take the **NEW Cable Wiring Harness** (500-6326-00) to **PREPARE** to connect or terminate the looped ends into the Connector from CN6. You will be **connecting** (terminating) the looped end of the **Black Wire** (Ground) to **Pin-1** and **connecting** (terminating) the looped end of the **Red Wire** (+5 volts) to **Pin-10** (See Figs. 2A & 2B).

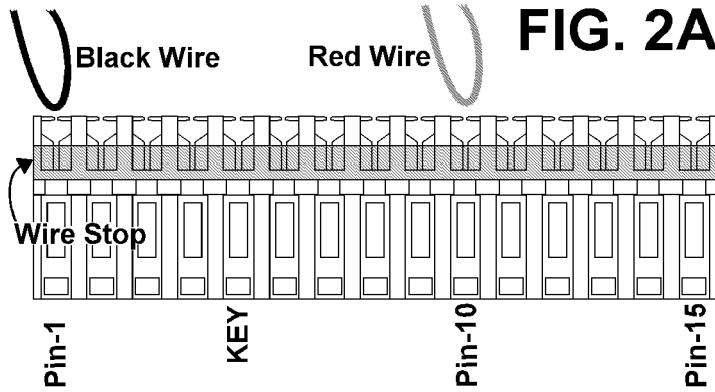

**Optional to use CN5. Please Read Note under STEP 1**

**STEP 3** To connect (terminate) the looped end of the wires, you **1ST** must remove the plastic **Wire Stop** on the Connector (*removed from CN6*) at **Pin-1 & Pin-10**. Carefully cut the **Wire Stop** out with a razor knife at **Pin-1** and **Pin-10** (See Fig. 3).

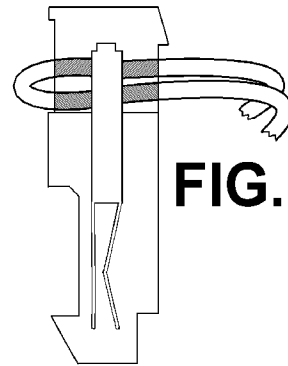
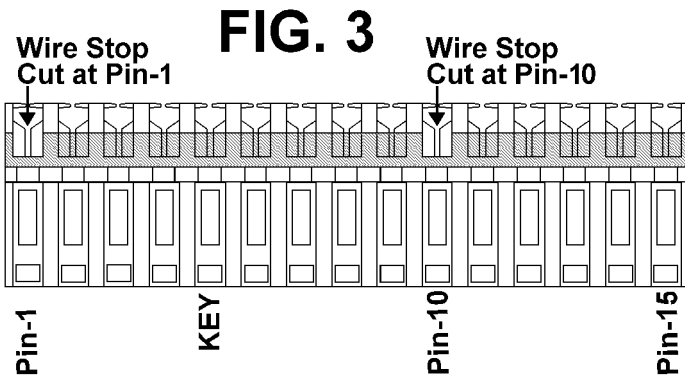

**FIG. 4**

**STEP 4** With a **MRT-Hand Tool** (or a screwdriver), you can now **punch down** (terminate the connection) the **looped end of the Black Wire** (Gnd) to **Pin-1** and **punch down** (terminate the connection) the **looped end of the Red Wire** (+5 volts) to **Pin-10** (See Fig. 4).

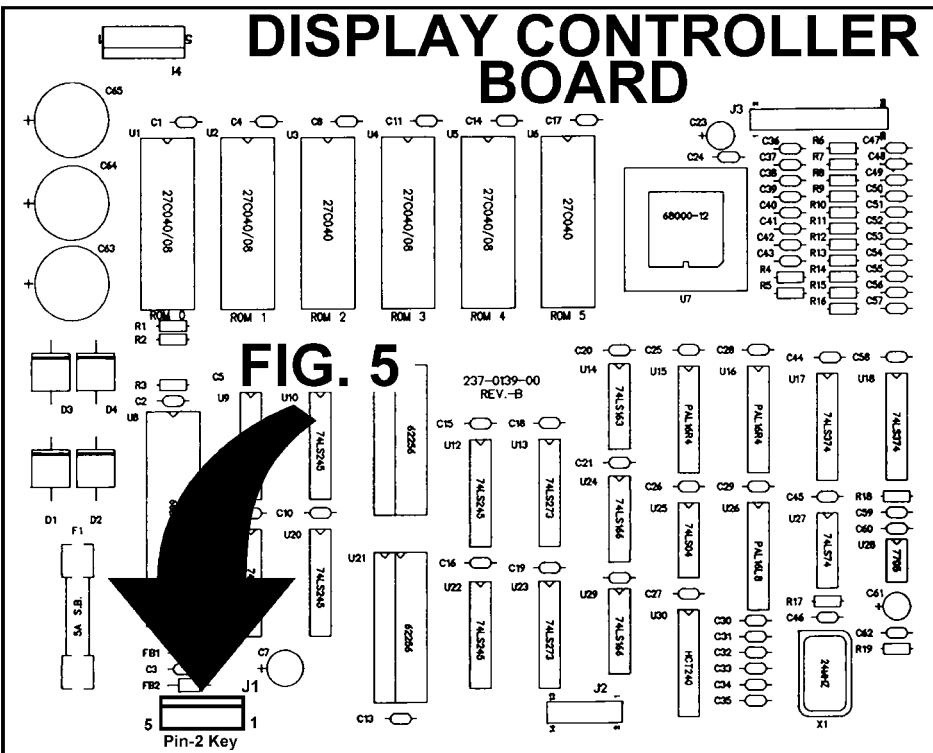

**STEP 5** Locate the Connector at **J1** on the **Large Dot Display Controller Board** (located behind the **Lg. Dot Display Bd**) (See Fig. 5) and remove from the board. **This Connector will no longer be used.** Tie back & tape-off or cut the **IDC Connector** off, tape-off the ends and tie these **now unused wires** back.

With the **NEW Cable Wiring Harness Red & Black Wire** looped ends now connected into **Pin-1 & Pin-10** in **CN6** on the **Power Supply Board**, dress the **Red & Black Wires** with the **5-Pin IDC Connector** down to the **Display Controller Board**.

Connect the **NEW Cable Wiring Harness 5-Pin IDC Connector** end onto **J1** (Keyed at **Pin-2**). The doubled **Black Wire** (Ground) is connected at **Pin-3** and the doubled **Red Wire** (+5v) is connected at **Pin-1**.

Any questions or concerns please contact Technical Support at the below numbers.

(S.B. 106 Revised, original date 4/20/98)