

OPERATING AND SERVICE MANUAL

10529A

EXTERNAL REFERENCE KIT

OPTION 003

(10529-60006)

Copyright HEWLETT-PACKARD COMPANY 1973
5301 STEVENS CREEK BLVD., SANTA CLARA, CALIF. 95050

Printed: JUL 1973

Manual Stock No.
10529-90006

Printed in U.S.A.

HEWLETT  PACKARD

CERTIFICATION

The Hewlett-Packard Company certifies that this instrument was thoroughly tested and inspected and found to meet its published specifications when it was shipped from the factory. The Hewlett-Packard Company further certifies that its calibration measurements are traceable to the U.S. National Bureau of Standards to the extent allowed by the Bureau's calibration facility.

WARRANTY AND ASSISTANCE

This Hewlett-Packard product is warranted against defects in materials and workmanship. This warranty applies for one year from the date of delivery, or, in the case of certain major components listed in the manual, for the specified period. We will repair or replace products which prove to be defective during the warranty period provided they are returned to Hewlett-Packard. No other warranty is expressed or implied. We are not liable for consequential damages.

Service contracts or customer assistance agreements are available for Hewlett-Packard products that require maintenance and repair on-site.

For any assistance, contact your nearest Hewlett-Packard Sales and Service Office.

1. INTRODUCTION

This Operating and Service Manual provides operating and service information for the 10529A Option 003 (10529-60006) External Reference Kit. No electrical specifications for the 10529A are altered by use of the 10529-60006.

2. DESCRIPTION

Option 003 plugs into the 10529A and provides an external reference clip and external power supply BNC connector.

An important class of board testing is the board comparison method. Two identical boards are simultaneously stimulated and their response compared. One board is a reference whose operation is known to be good. The other is the board under test. The External Reference Kit allows this time-proven comparison technique to be easily extended to the component level. The two boards in the board tester are identically stimulated. Option 003, uses the IC's on the known good board as a reference to compare the IC's on the board under test. By simply attaching the two clips to corresponding IC's, a quick test of the components can be made. Any logical differences between the reference and test IC's, on either input or output pins, are indicated by a lit LED for those pins. Power for the Logic Comparator is derived from a separate cable attached to the +5-volt supply of the board tester.

3. OPERATION

Open the drawer on the 10529A. Insert the 10529-60006 External Reference Kit into the drawer as shown in Figure 1. Close drawer. Connect the BNC to +5V power supply. The +5V supply should be referenced to the supply of the circuits under test. When the supply is turned on, the comparator "ON" LED should light.

CAUTION: Voltage inputs greater than $>7V$ will damage the comparator.

Connect reference clip to reference IC on reference board with "PIN 1" of the clip to pin 1 of the IC. Connect comparator clip to test IC on test board with "PIN 1" of clip to pin 1 of IC. Any Logical differences between the reference and Test IC's, on either input or output pins, are indicated by a lit LED for those pins.

4. MAINTENANCE

There are no adjustments or preventive maintenance procedures for the External Reference Kit. The following check verifies proper operation of Option 003.

Install External Reference Kit into the 10529A Logic Comparator. Connect the External power supply BNC to a +5V power supply.

With power applied, the "ON" LED on the Comparator should light. Individually short each Reference Clip pin to the negative side of the +5V supply. Each LED should light when its pin is shorted.

Measure the voltage on each pin of the Comparator Clip with respect to the negative side of the power supply. There should be +5 volts on each pin.

Recommended test equipment:

HP 6214A Power supply 10V, 1A
HP 427A Multi function Meter

To replace the clip covers proceed as follows:

CAUTION: The new clip covers are more susceptible to damage if extreme care is not used in removing the body from its covers. Therefore it is recommended that new covers be ordered whenever disassembly is attempted. When replacing any item, extreme care must be exercised to prevent damage to the internal parts.

DISASSEMBLY

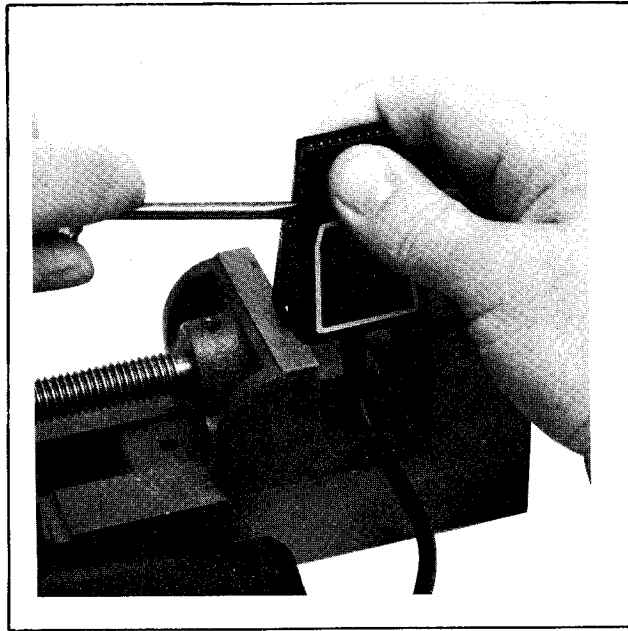

Figure 1

1. Place the clip covers across a support so the cable is not restricted.
2. Insert a flat blade screwdriver between the cover halves as shown, or use tool shown in Figure 5.
3. Hold the clip small end firmly closed.
4. Press down firmly on the point of the screwdriver forcing the body out of the cover.

ASSEMBLY

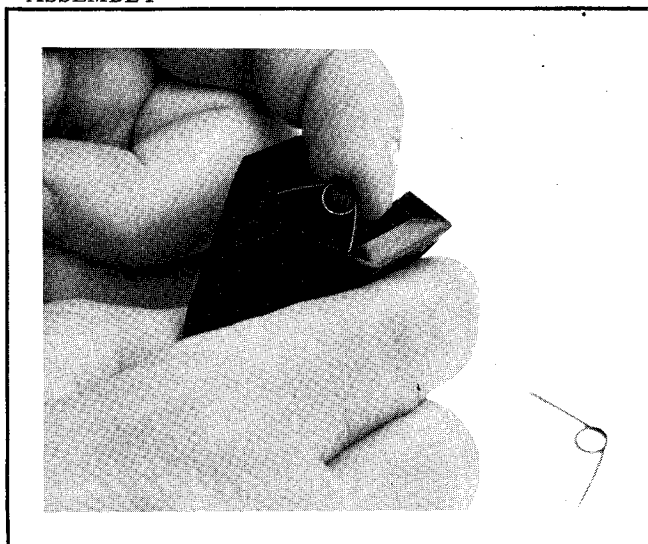

Figure 2

1. Place the inside of the cover halves facing each other with the pin on one side opposite the hole on the other.
2. Place the cover teeth end down on a table.
3. Push gently as if to slide one half past the other until the sides snap together.
4. Squeeze the spring tips and insert it as shown in Figure 2.
5. Rotate the coil part of the spring down into the cover assembly. Install two springs each side.
6. Position the spring coil parts against the flat side of the cover and with the ends in the grooves.
7. Remove the protective paper from the foil labels and place the adhesive side on the cover face.

NOTE

A pad of gum rubber $3/16'' \times 3/4'' \times 1/2''$ will be required. This can be cut from a regular pencil eraser or plastic eraser.

8. Insert the rubber pad between the covers just behind the pin guides as shown in Figure 3. Check for burrs on the detent rounds of the body.
9. Lift the edge of the printed circuit card causing the tips of the pins to separate.
10. Locate the pin with a gray wire. This is pin number one and must be at position "1" identified on the cover.
11. Insert the pins into the covers guiding them into their respective grooves.
12. Squeeze the teeth end of the cover.
13. Push the body (rock gently from side to side) until the pins are seated in the cover guides.
14. Place teeth end of cover in vise as in Figure 4, use soft protective material over vise jawfaces, tighten vise just enough to bring pin guides together.
15. Push down with your thumbs until the body snaps into the cover.
16. Remove the rubber pad.
17. Test the comparator for proper operation.

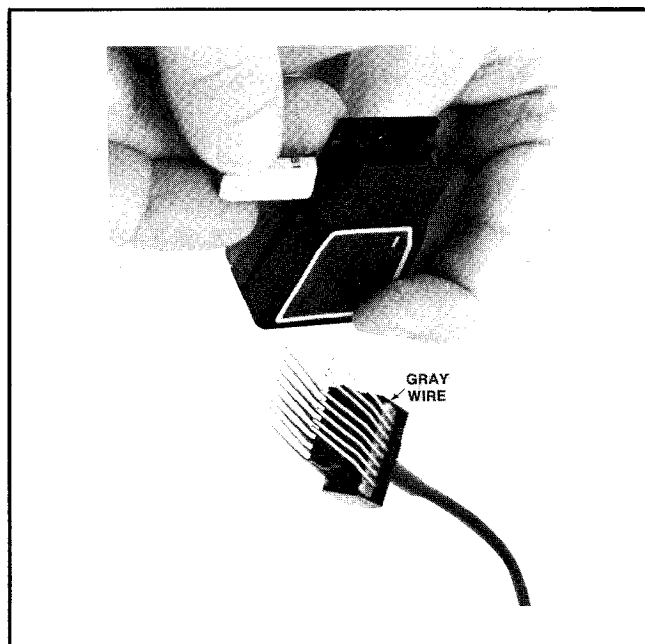

Figure 3

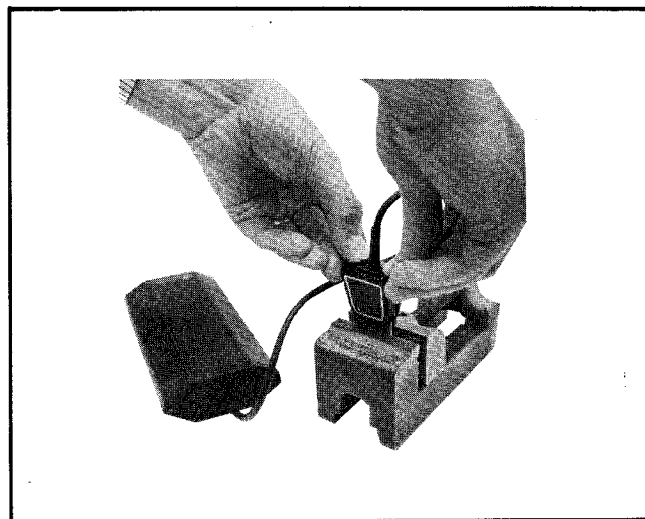

Figure 4

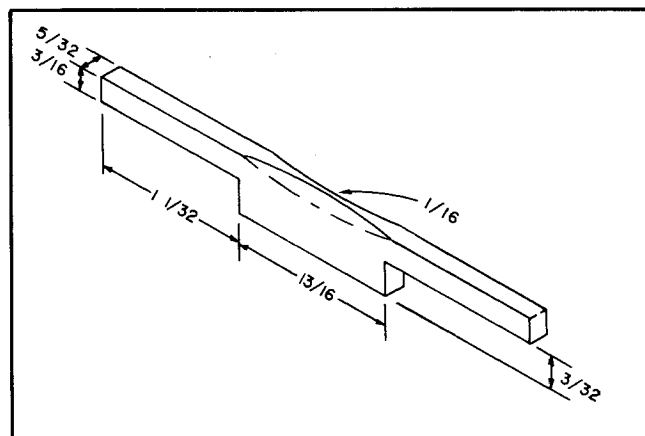

Figure 5

Replacement Parts for 10529A Option 003

HP Part Number	Quantity	Description
10529-20013	1 each	Board Blank
10529-40006	1 each	Cover/clamp
10529-60008	1 W1	Cable Assembly Clip
10529-60009	1 W2	Cable Assembly - +5V
1810-0055	R1	Resistor 10K
1810-0055	R2	Resistor 10K
		Clip Assembly Replacement Parts
10528-40001	2 each	Cover
10528-20002	2 each	Spring
10529-20001	2 each	Printed Circuit Board
10529-20007	16 each	Contact
7120-2725	1 each	Label 7 Volt
7120-2727	1 each	Label Pin 1

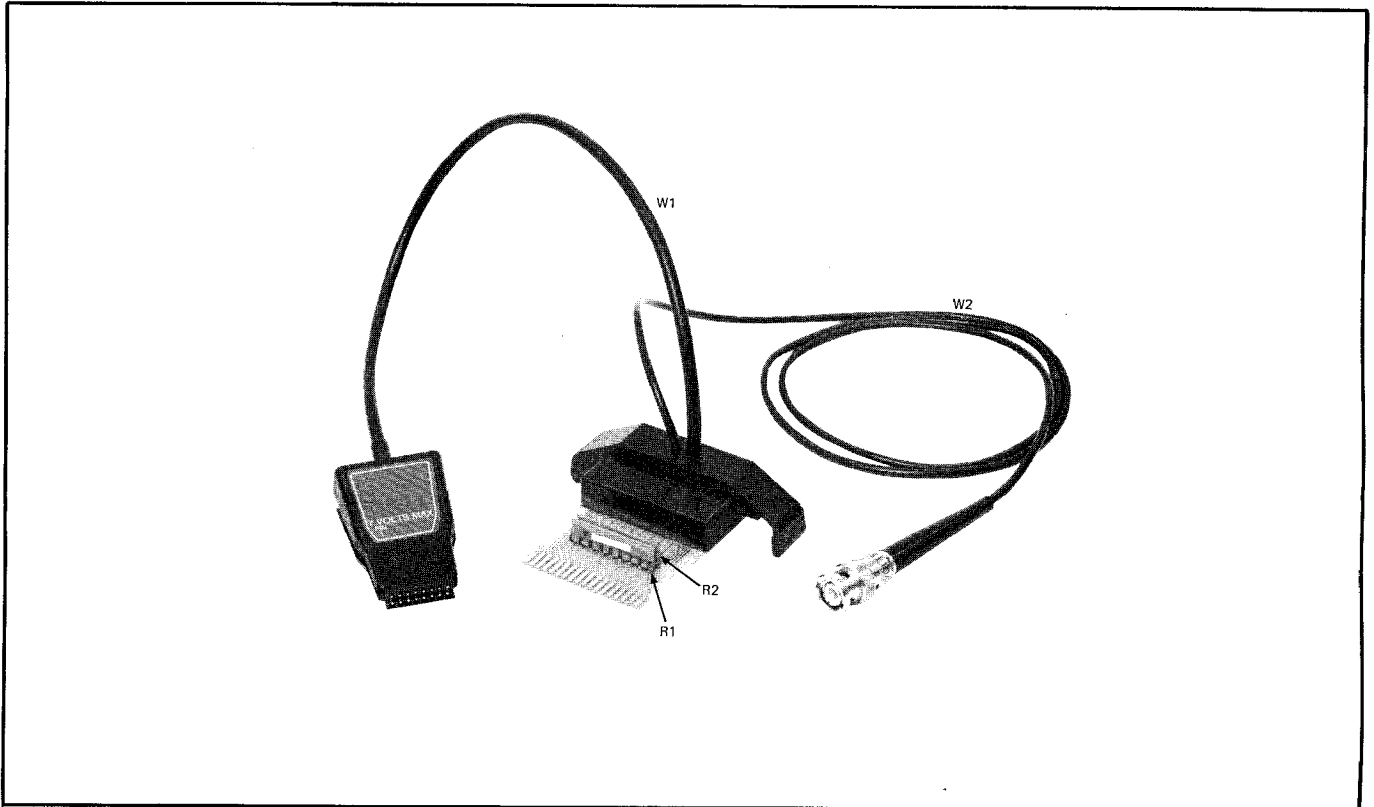

Figure 6A. Option 003

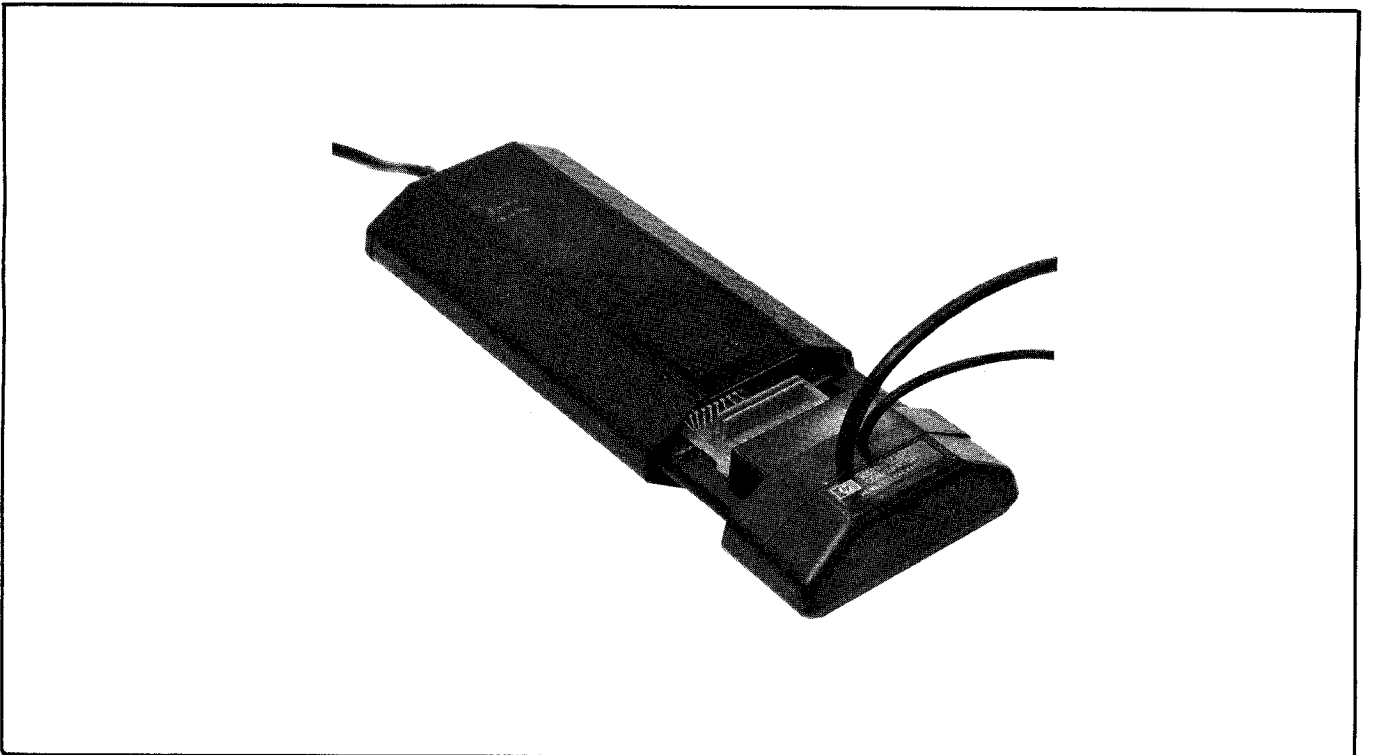
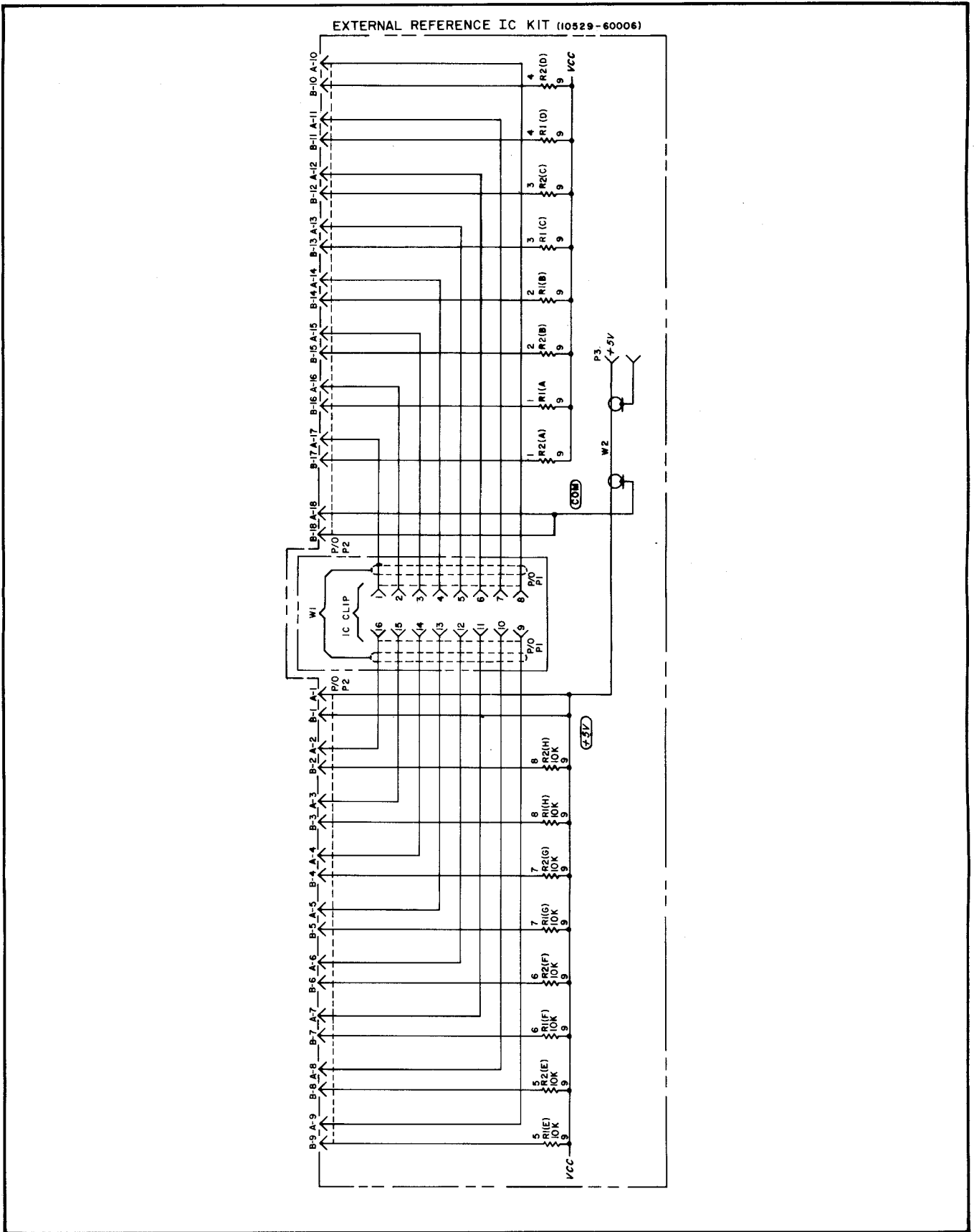

Figure 6B. 10529A with Option 003

Figure 7. External Reference Kit (10529-60006)



SALES OFFICES

NEELY SALES

Hewlett-Packard Co.
3939 Lankershim Blvd.
NORTH HOLLYWOOD, CA 91604
Tel: (213) 877-1282
Regional Headquarters

EASTERN

Hewlett-Packard Co.
2 Choke Cherry Road
ROCKVILLE, MD 20850
Tel: (301) 948-6370
Telex: 710-828-9685
A,CM,CP,E,MP

MIDWEST

Hewlett-Packard Co.
5201 Tollview Drive
ROLLING MEADOWS, IL 60018
Tel: (312) 255-9800
A,CM,CP,E,MP

SOUTHERN

Hewlett-Packard Co.
P.O. Box 105005
2000 South Park Place
ATLANTA, CA 30339
Tel: (404) 955-1500
Telex: 810-766-4890
A,CM,CP,E,MP

EUROPEAN AREAS CONTACT

Hewlett-Packard S.A.
7 Rue du Bois-du-Lan
CH-1217 **MEYRIN 2**, Switzerland
Tel: (022) 83-81-11
Telex: 27835 hpse
Cable: HEWPACKSA Geneve

EAST EUROPEAN AREAS CONTACT

Hewlett-Packard Ges.m.b.h.
Wehlistrasse 29
P.O. Box 7
A-1205 **VIENNA**
Tel: (222) 35-16-210
Telex: 135823/135066

MEDITERRANEAN AND MIDDLE EAST CONTACT

Hewlett-Packard S.A.
Mediterranean & Middle East
Operations
35, Kolokotroni Street
Platia kefallariou
GR-Kifissia, **ATHENS**, Greece
TEL: 808-0359, 808-0429
Telex: 21-6588
Cable: HEWPACKSA Athens

INTERNATIONAL AREAS CONTACT

Hewlett-Packard Co.
Intercontinental Headquarters
3495 Deer Creek Road
PALO ALTO, CA 94304
Tel: (415) 857-1501
Telex: 034-8300
Cable: HEWPACK

For more information contact a local Hewlett-Packard Office. (Hewlett-Packard has 200 Sales and Service Offices in 75 countries.) Or write: Hewlett-Packard, 1501 Page Mill Road, Palo Alto, California 94304, U.S.A.